

**YASKAWA**

# Motion Control Products

Confident. Consistent. Capable of More.

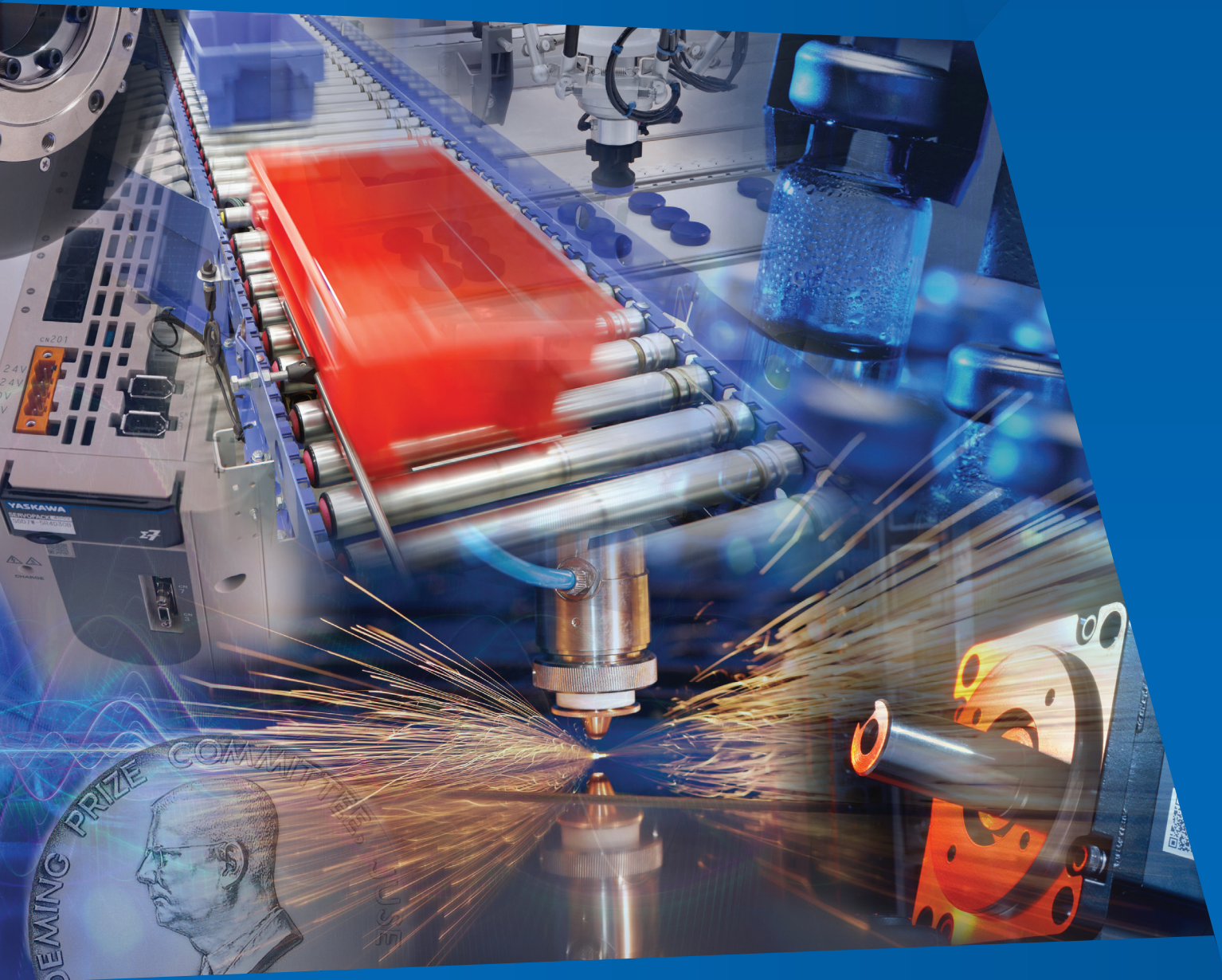



# Be Capable of More

Machine builders and equipment users face high expectations, limited resources and tight deadlines. For you, improvement means suppliers with the products, knowledge and rock solid support to solve production problems day in and day out.

Yaskawa has been putting this brand of customer success in motion for 100 years. It shows in today's commitment to automation innovation, engineering expertise, and operational strength that is the proof behind our promise.



Confident

## Products That Satisfy

Product performance means more than just a specification. It's also the confidence that your machines will work as expected, in a way that consistently outperforms your competition.

**Breakthrough performance-** Your machine functions at a level that can't be achieved with other automation solutions.

**A competitive price-** You can provide an effective, trustworthy solution at a cost that makes your machine an exceptional value.

**Quality, right out of the box-** Your systems work as expected, the first time and every time.



Consistent

## Excellence in Operation

Problems with component quality, supply chain hiccups and downtime surprises are simply unacceptable. You need a partner with the operational rigor and expertise to engineer them out of existence.

**Inventory for faster fulfillment-** Your products are available precisely when and where you need them.

**Legendary quality-** Your equipment continues to operate reliably and without intervention.

**Global service and support-** You can rely on timely, helpful technical assistance wherever you or your equipment may be.



Capable

## Engineering Expertise. Now.

Focus your engineers on their core competencies, thanks to a team of Yaskawa engineers who can instantly add value to automation design, development and support.

**Motion application expertise-** Call on our automation experts to assist with electromechanical design and development.

**Software development-** Turn to a team of automation software specialists to streamline your development process.

**Engineered systems-** Implement complete mechanical and electrical sub-systems that are fully supported for the life of your machine.

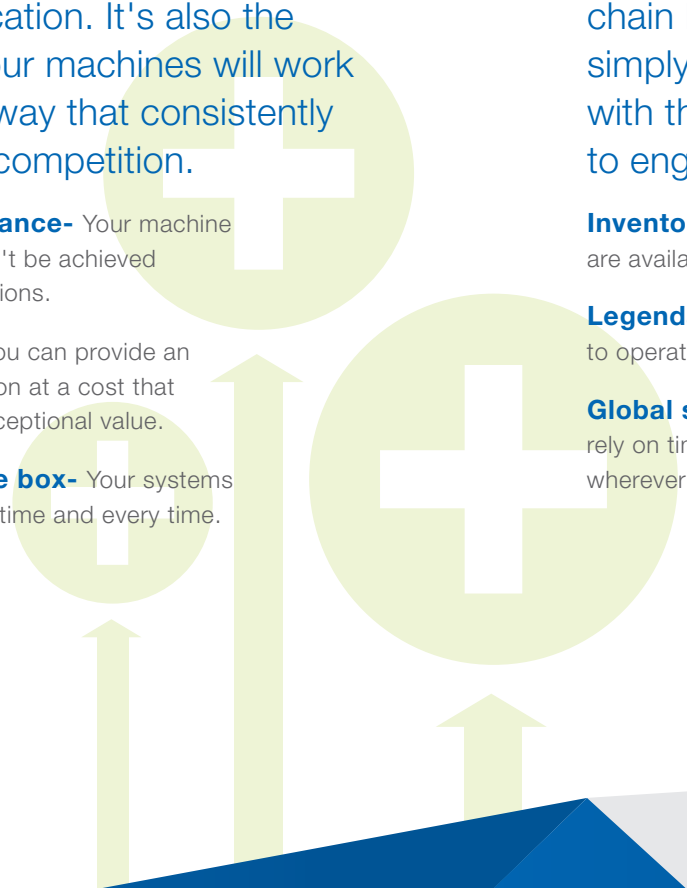

**IT'S PERSONAL**

**"It's Personal" is our commitment to giving you a great experience each time you deal with Yaskawa.**

We train people, create products and treat customers with the belief that every single thing we do matters. With an attitude like this, it's only natural to see everything we do as an intensely personal act.

We commit to that at Yaskawa. We make it happen.

**Because to us ... it's personal.**



Products That Perform.

# Power Up Your Productivity

## When More is Not Enough

In a rapidly changing global marketplace, today's achievements are tomorrow's expectations. Your customers demand the maximum in both machine throughput and quality, regardless of mechanical and design limitations. Your job is to do it all, and at a competitive cost.

### Your Need: Performance Plus

Staying ahead of competition means constantly pushing the edge of the envelope on machine performance. This extreme effort consumes your time, stresses machine mechanisms and impacts the reliability of finished products. The result is a risk of lost revenue, or of disappointing key customers.

Your world has no room for components that can't be trusted, or for suppliers that create delays in development and delivery.

#### What if ...

- You could reduce...or even eliminate...the time spent optimizing your machine's motion performance?
- Your servo system could overcome the mechanical limitations of your design?
- You could confidently achieve big improvements in throughput and effectiveness?

Product performance is more than just a specification.



### Your Gain: Three Productivity Boosts

Motion control systems from Yaskawa give you real impact on equipment effectiveness. This creates confidence that a machine will work as expected every time, which gives you an advantage over your competitors.

#### Tuning Time Savings

Yaskawa's well earned reputation for industry-leading performance is enhanced by our Tuning-less Mode, which eliminates the need to optimize tuning gains. Vibration Suppression automatically compensates for limitations in a machine's mechanical design, creating more consistent performance.

#### Initial Quality

Defining initial quality is simple: you get what you want. Yaskawa products ship on time, work right out of the box, perform as expected, and continue to do so for the life of your machine.

#### Competitive Price

Yaskawa maintains a #1 market share in some of the world's most price-sensitive industries, which is proof of Yaskawa's superior balance between operational performance and return on your investment.



Be Confident



# Resources, Responsiveness and Reliability

## Today, Quality is Only the Beginning

Your machines must operate anywhere in the world, yet one expectation is universal: the need for instant gratification in product availability, flawless performance and 24/7 service and support.

### Your Need: Speed and Success

When customers demand instant perfection, you can't afford to work with ordinary suppliers. Everyone in your supply chain must be completely reliable in supply and rapid in response to any customer question.

Quality problems simply cannot be part of the equation. Nor can a shortage in engineering support in a fast-tracked machine design process.

### What If ...

- You had no worries about the reliability of your automation system?
- You could reduce your machine lead time and spare parts inventory?
- You had expert service and support everywhere your machines are located?

Be Consistent

## Yaskawa quality is the industry benchmark.

From 2011 to 2013, Yaskawa shipped nearly 150,000 motors in North America with only 10 warranty failures.



### Your Gain: Global Excellence

Yaskawa has a long track record for reliable quality, responsive support and rapid product availability. The reason behind these achievements is a simple one: our customers can't afford to settle for anything less.

#### Inventory for Faster Fulfillment

Yaskawa maintains a \$14M inventory of motion products in the US, for 95%+ on-time response to customer requests.

#### A Legacy of Quality

Yaskawa's award-winning quality has been the motion industry's benchmark for decades. Yaskawa products practically never fail, and we can stand behind this statement with 100 years of evidence.

#### Global Service and Support

As a truly global company with locations in 25 nations worldwide, Yaskawa can offer local experts in service and support whether your machine is installed in Asia, Europe or the Americas





# Insight and Innovation, Instantly.

## Top Resources for Tough Problems

Today's companies face an acute talent shortage, yet the demand for innovative technology is stronger than ever. New designs must be brought to market in months or weeks instead of years, without sacrificing efficiency, flexibility and quality.

Many companies can't afford a large engineering staff. The few who can must compete for engineers with automation expertise.

### Engineers, or Firefighters?

Your engineering staff needs to focus on your company's core competencies. Instead, they are distracted with putting out fires when they should be creating innovations.

These limitations slow the development of new ideas, and lead to unreliable long-term operation of your machine. Trial and error in the development process is no longer an option. Nor is downtime or lost production.

#### What If ...

- You could add expert automation engineers to your staff at the exact moment you need them?
- Responsibility for automation design and support could be handed off to someone you trusted?
- Your engineering staff was free to focus on areas where they can truly add value?

You no longer have the luxury of a large engineering staff.

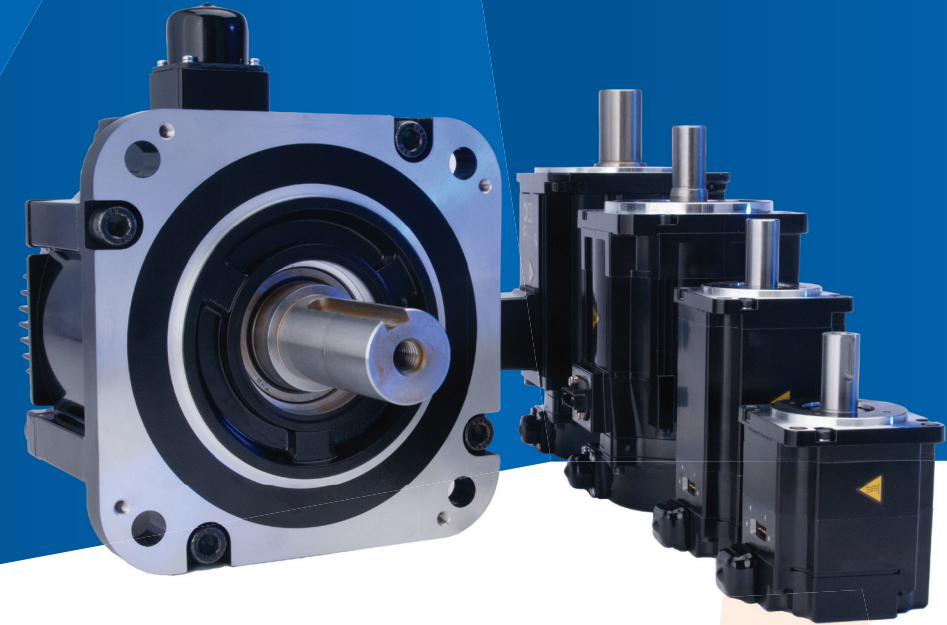

### Your Gain: Effective Innovation

For the past 100 years of industrial history, Yaskawa engineers have learned to work as an extension of your engineering staff to create elegant, reliable automation. The Yaskawa commitment begins by listening, fully understanding your application and process, your time frame, cost structure and the results you need to achieve. This effort sets us apart, and it results in tangible benefits that go directly to your engineering bottom line.

#### Motion Application Expertise

Yaskawa's engineering expertise can be applied to any stage of machine development.

- System concept design
- Component selection
- Electrical design
- Mechatronic design
- Machine start-up
- Programming
- Optimization
- Troubleshooting

#### Software Development

Software design and development can be the key to the success or failure of an automated machine. Yaskawa software expertise makes the difference, thanks to a staff with equal expertise in software design and real-world machine operation.

#### Engineered Systems

Under the banner of Engineered Systems, Yaskawa offers a range of advanced products and services. They include complete machine retrofits, enclosure design and manufacturing, electromechanical assembly design, and integration of Yaskawa servo technology into a "purpose built" mechanism for your application.



Be Capable of More



# Global Overview

## Yaskawa—World Leader in Automation, Drive Technology, and Robotics

Yaskawa is the world's largest manufacturer of motion control devices, AC drives and robotics. Since 1915, we have been a pioneer in the drive to optimize the productivity and efficiency of machines and industrial systems.

- \$4B/year in global sales
- 1 million servo motors per year
- 800,000 servo amplifiers per year
- 1.8 million inverters per year
- 20,000 robots per year
- Over 14,500 associates worldwide
- Yaskawa Sales, Service, and Manufacturing companies in 25 countries

### Yaskawa Global Locations

#### North America & South America

U.S.A.  
Brazil  
Canada  
Mexico

#### Asia Pacific

China  
Japan  
Korea  
Taiwan  
Singapore  
Thailand  
Indonesia  
India

#### Africa

South Africa

#### Europe

Germany  
Sweden  
U.K.  
Israel  
Italy  
France  
Spain  
Finland  
Netherlands  
Slovenia  
Czech Republic  
Turkey



Over the past 30 years, Yaskawa has produced more than 10 million servo amplifiers, 18 million variable frequency drives, and 300,000 robots.

## Product Portfolio: Total System Solutions

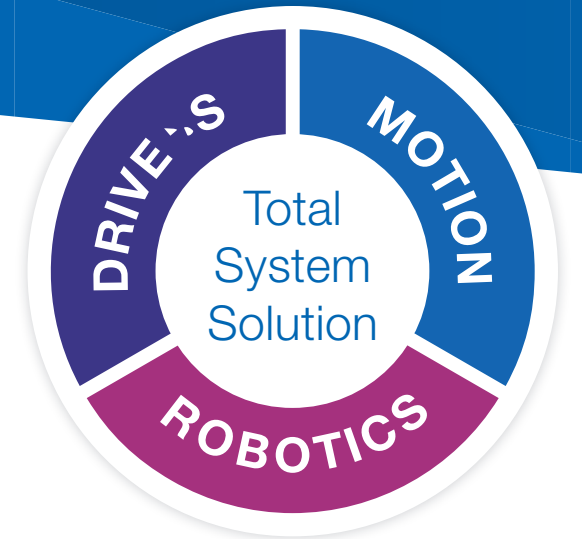

### Software

#### Software

MotionWorks® IEC, Yaskawa's IEC61131-3 programming environment, gives a programmer the best of several programming languages in one development platform.



### Control

#### Machine Controllers

MPiec Machine Controllers integrate Yaskawa's powerful motion engine with the IEC61131-3 and PLCopen programming standards, for control from 1 to 62 axes.



### Input/Output

#### I/O

Yaskawa VIPA SLIO is one of the most effective and modern decentralized I/O systems available, providing exceptional usability in an extremely compact and functional design.



### Servo Amplifiers & Motors

#### Sigma Series Servo Systems

Rotary, Linear and Direct Drive servos from 3 W to 55 kW offer advanced features, including Tuning-less Mode, vibration suppression, ripple and friction compensation.



### Variable Speed Drives

#### Inverter Drives

Yaskawa drives incorporate the latest technological advancements in variable speed AC motor control, with power ranges from fractional HP to 2250 HP.



### Robotics

#### Robotics

The Yaskawa Robotic product portfolio ranges from 4-15 axis industrial robots to special machines, devices and turnkey systems.





# MPiec Machine Controllers

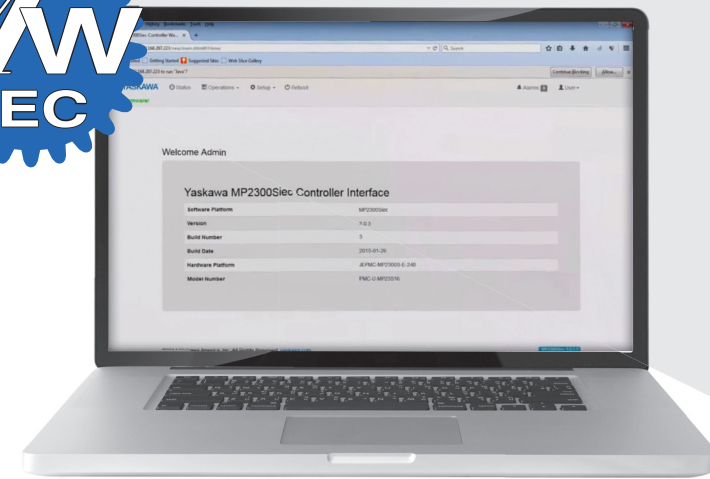

## Easy for You. Consistent for Everyone.

To stay a step ahead, you need programming software that is easy to learn, familiar in format and efficient to work with.

Your controller hardware must be accessible to a world of peripheral devices, while keeping function control and user experience perfectly consistent from machine to machine.

### The Demand: Flexible PLUS Reliable

Today's customers need a finger on the pulse of their machines at all times. Success demands peak productivity, total reliability and endless freedom to interact.

#### What if ...

- Key elements of code are already written for you, using a standard, globally recognized programming language?
- Customers can safely access your machine controller from anywhere in the world?
- Programming one of your machines easily leads to programming all your machines?

### Yaskawa Control: What You Gain

With easy-to-learn MotionWorks® IEC software and MPiec hardware, your engineers start programming quicker and stay connected more easily.

The result? Faster machine commissioning and more rapid machine delivery to market.

#### A Familiar Programming Standard

MotionWorks IEC complies with IEC61131-3, and provides five globally recognized standard programming languages. It includes motion function blocks that adhere to the PLCopen standard. Experienced control engineers will find this software comfortably familiar, and learning to program with MotionWorks IEC has never been easier.

#### Built-in Yaskawa Toolboxes

Yaskawa toolboxes make programming common functions so easy, it's like having a Yaskawa engineer working by your side. Standard code elements are already written and ready for use, reducing development time.

#### A Reusable Code Library

Import and re-use previously developed logic to speed up new projects. Re-use your own work or use logic created by others.

#### Easy Connectivity, Worldwide

An MPiec controller is your gateway to full remote control of a machine at any location with internet access. Keep a constant finger on the pulse of machine operation, from your own factory floor or from poolside worldwide.

#### Web Server Updates

MPiec controllers allow loading of programs and updating of firmware from any web browser, with no other software required. Browser-based controller status data helps reduce maintenance time and cost.

#### Scalability

All our single-axis to multi-axis MPiec controllers utilize the same MotionWorks IEC software platform, making programming and maintenance consistent for all machine sizes.

#### Three Networks to Choose From

MPiec controllers include the MECHATROLINK motion network, plus Modbus TCP and EtherNet/IP communication networks at no extra cost. This ensures an economical way of connecting to all the devices in your machine.



All your machines need to feel and function in exactly the same way.



# System Configuration

**MPiec Controller**

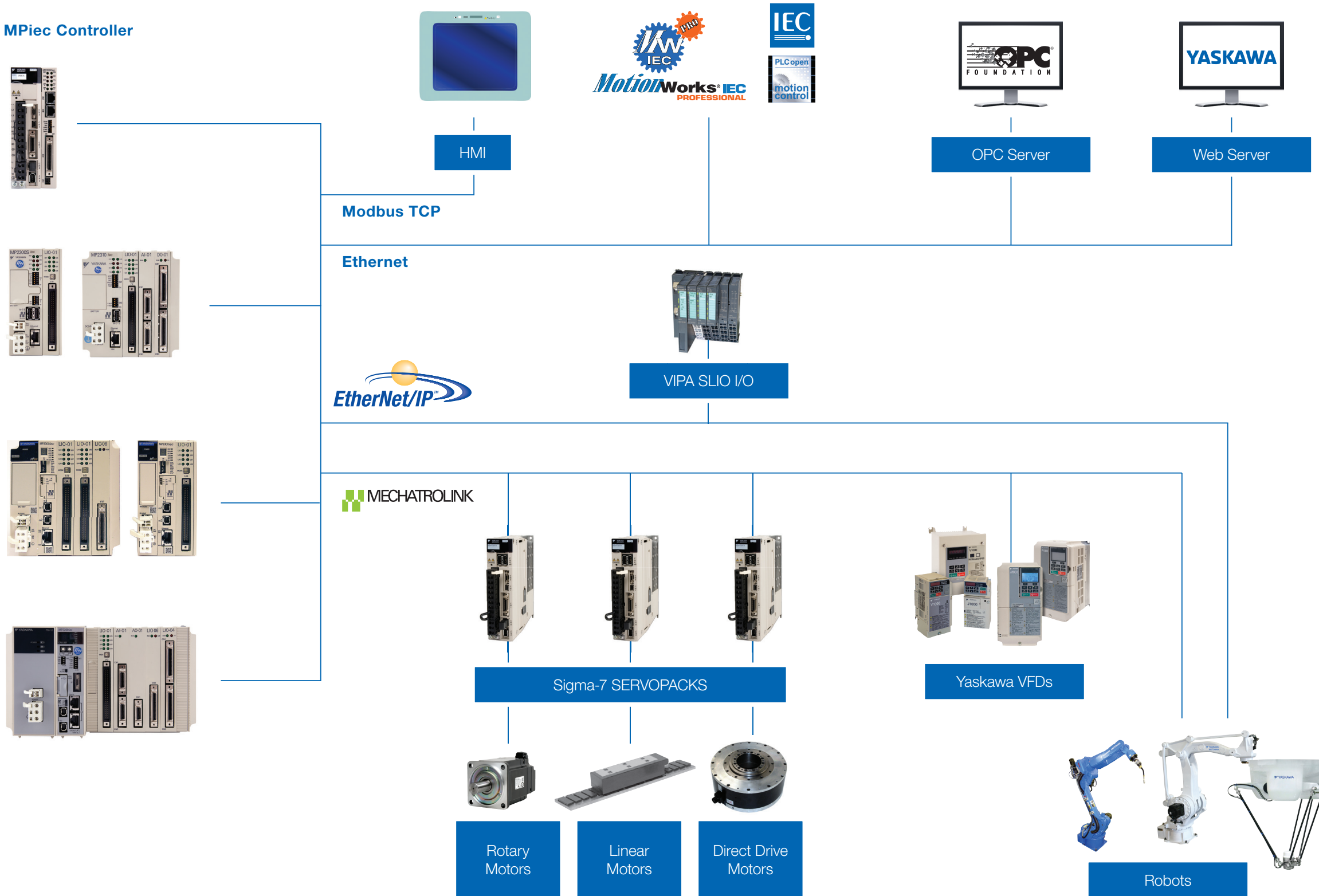

**A controller that gets you to the position you want, when you want it:**

- Deterministic high speed MECHATROLINK network
- MECHATROLINK retry function
- Dedicated CPU for your motion needs
- High CPU scan rate

**Program all of your controllers the same way every time:**

- Standard IEC 61131-3 programming languages
- Reusable PLCopen function blocks
- Reusable standard Yaskawa toolboxes
- Decades of high quality motion experience

**Your entire machine at your fingertips with Yaskawa controllers:**

- Sigma-7 servos via MECHATROLINK
- Built in web server
- OPC server
- EtherNet/IP
- Modbus TCP
- Wide range of HMIs and I/Os

# Software



- Number of Tasks: 1
- Number of Resources: 1
- IEC 61131-3 Languages: Ladder Diagram, Function Block, Structure Text
- POU Grouping: No
- Configurable Task Priority: No
- Configurable I/O Task Assignment: No
- Auto Save Setting: No
- Debug PowerFlow: No
- Password Protection: No
- Project Comparison: No



- Number of Tasks: 16
- Number of Resources: Multiple
- IEC 61131-3 Languages: Ladder Diagram, Function Block, Structure Text, Sequential Function Chart, Instruction List
- POU Grouping: Yes
- Configurable Task Priority: Yes
- Configurable I/O Task Assignment: Yes
- Auto Save Setting: Yes
- Debug PowerFlow: Yes
- Password Protection: Yes
- Project Comparison: Yes

## Reusable Code and Yaskawa Application-specific Toolboxes

Yaskawa uses decades of motion experience to create toolboxes with pre-developed code for specific applications, minimizing programming time and effort. Libraries also enable re-use of logic you've previously developed, saving even more time on subsequent projects.

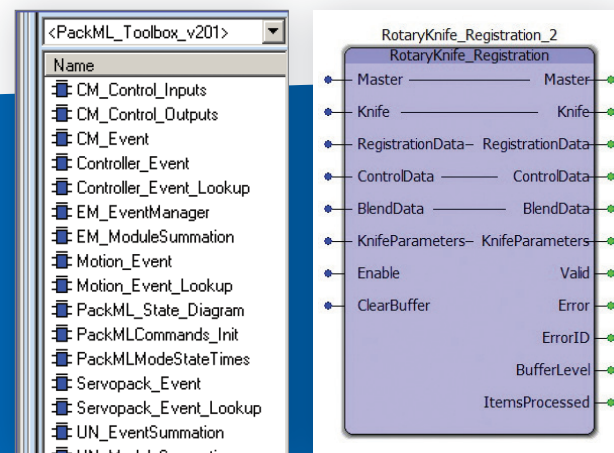

## Sequential Function Chart

Sequential Function Chart (SFC), one of the standardized languages available in IEC 61131-3, is supported in the Professional version of MotionWorks® IEC.

SFC allows the programmer to graphically represent program elements, for easier organization of steps, actions and transitions. Active steps are indicated in red to simplify troubleshooting of complex operations.

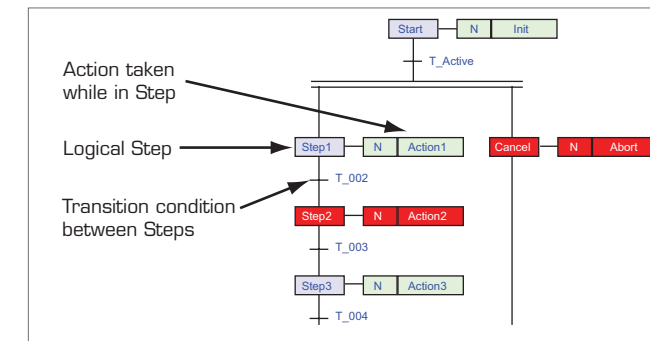

## Standard Programming Environment



MotionWorks IEC software complies with the IEC 61131-3 standard. It also has motion function blocks that adhere to the PLCoPen standard, assuring that programs will be developed and executed with predictable behavior.

## Cam Editor

A Cam Editor built into MotionWorks IEC Pro creates, edits, exports and imports Cam profiles, and converts Cam tables back and forth from ST code for programming use.

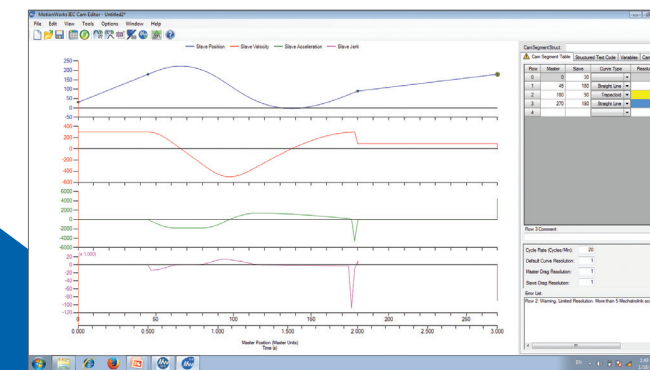

## Camming Function Blocks

Electronic camming controls the positional relationship of a pair of axes based on a master/slave lookup table.

MotionWorks IEC includes 10 function blocks dedicated to camming. Yaskawa creates customizations based on the PLCopen specification, previous controller cam technology, and decades of synchronized motion experience. The function blocks fall into one of four functional topics:

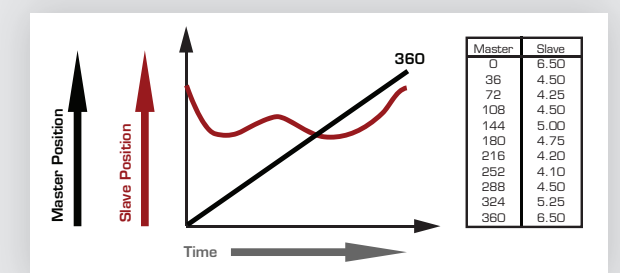
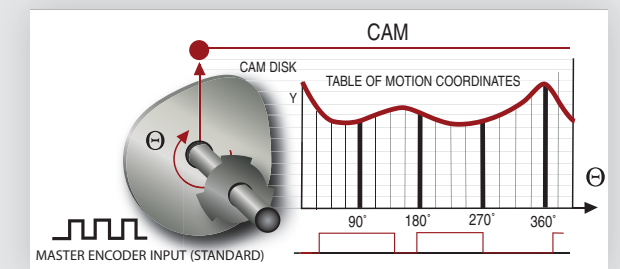
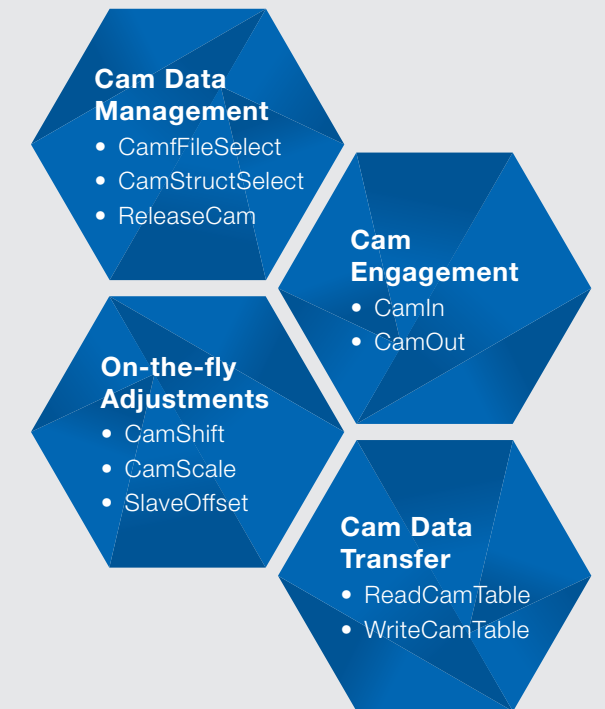



# Controller Hardware

You need powerful processing to prepare for tomorrow's innovations, without sacrificing today's cost effectiveness and ease of use. MPiec machine control offers both, plus extra features that add user flexibility.

All MPiec Machine Controllers are equipped with the MECHATROLINK motion network. MECHATROLINK combines the speed of modern motion networks with unmatched noise immunity and robust performance. MECHATROLINK responds to a communication error by automatically resending the faulty packet within the same cycle, minimizing data gaps even in extremely high noise environments.

Without this function, the master must retransmit at a higher rate to compensate for dropped information. The result can be poor quality in machined parts, as shown in the test data at right.

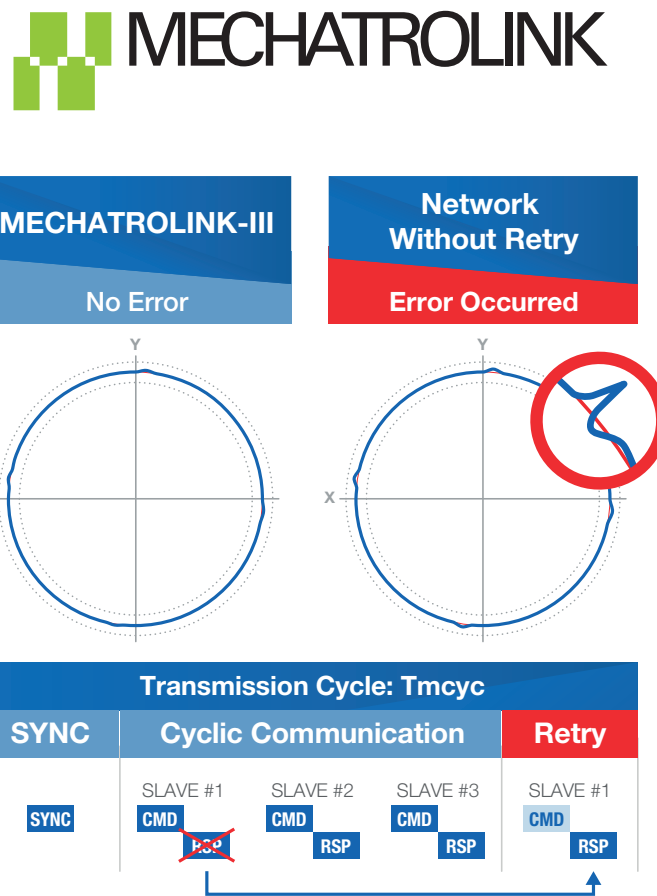

### Controller-Centric Commissioning

MECHATROLINK allows configuration from a single location with one software tool, minimizing commissioning time.

### Remote I/O

Interface using Yaskawa's own MECHATROLINK I/O, VIPA SLIO I/O, or third-party remote I/O modules from Phoenix, Wago or Opto 22 via MECHATROLINK or Ethernet.

### Local I/O

MPiec controller hardware can be expanded with your choice of eight option cards to suit any automation requirement.

### IEC on the Drive

The MP2600iec Option Card, combined with a SERVOPACK amplifier, offers a compact controller/amplifier combination for programming Yaskawa's latest high quality servo systems.

### Scalability

The use of one software platform for all MPiec Machine Controllers enables users to easily scale up their applications from single to multi-axis control.

### Programmable Amplifier Outputs

The controller can operate local outputs on a SERVOPACK, reducing panel cost and saving panel space when only a few outputs are necessary.

### Web-based System Access

MPiec Machine Controllers have a built-in web interface for better system access. Plug into a local network and adjust parameters using any web browser, or log in anywhere in the world via a secure internet connection.

- Monitor vital control status, diagnostic and alarm information
- Change settings or update firmware remotely
- Connect via cable and enjoy on-site control with your favorite browser, or access from any remote location
- Connect via Ethernet on a computer, an Android™ or Apple® tablet

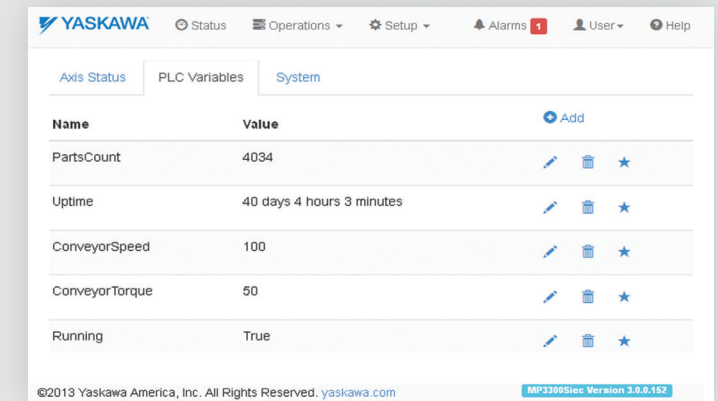

# Controller Hardware

MPiec Machine Controllers offer a wide range of hardware for applications ranging from 1 to 62 axes. All controllers are equipped with the reliable MECHATROLINK motion network.

## MP2600iec

- Option card for a SERVOPACK amplifier
- Processor Speed: 200 MHz
- Motion Network: Dual Port RAM access
- Motion Networks Speed: As fast as 1 ms
- Network Capability: OPC, EtherNet/IP, Modbus TCP
- Axis Count: 1.5



## MP2300Siec / MP2310iec

- Processor Speed: 200 MHz
- Motion Network: MECHATROLINK-II
- Motion Networks Speed: As fast as 1 ms
- Network Capability: OPC, EtherNet/IP, Modbus TCP
- Axis Count: 4, 8 or 16
- Option Card Slots: 1 or 3

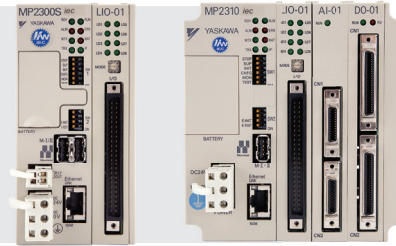

## MP3300iec

- Processor Speed: 400/800 MHz
- Motion Network: MECHATROLINK-III
- Motion Network Speed: As fast as 0.25 ms
- Network Capability: OPC, EtherNet/IP, Modbus TCP
- Axis Count: 4, 8, 20 or 32
- Option Card Slots: 1 or 3

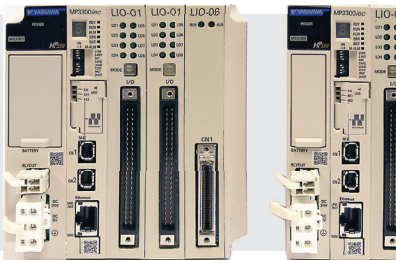

## MP3200iec

- Processor Speed: 1 GHz
- Motion Network: MECHATROLINK-III
- Motion Networks Speed: As fast as 0.25 ms
- Network Capability: OPC, EtherNet/IP, Modbus TCP
- Axis Count: 4, 8, 16, 32 or 62
- Option Card Slots: 3, 5 or 8

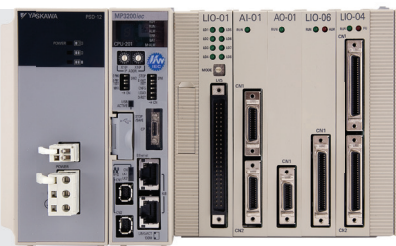

## System Components

MECHATROLINK-III Network Components			
Description	Part Number	Notes	
MP3200iec	CPU Module	PMC-U-MP320 □□	□□: Maximum number of MECHATROLINK Axes: 04:4 • 08: 8 • 16:16 • 32:32 • 62:62
	Power Supply Module	JEPMC-PS□3012-E	□: Input Power D: 24 VDC • A: 100/200 VAC
	Option Module Rack	JEPMC-BUB300□-E	For optional I/O modules □: Slot number: 3:3 slots • 5: 5 Slots • 8: 8 Slots
MP3300iec	CPU Module	PMC-U-MP33#□□	#: 0: Standard IMI CPU • 3: Medium IMI CPU • 5: High IMI CPU • 1: Standard RJ45 CPU • 4: Medium RJ45 CPU • 6: High RJ45 CPU □□: Maximum number of MECHATROLINK Axes: 04:4 • 08: 8 • 20:20 • 32:32 • 62:62 (Note: Standard CPU up to 20 axes, Medium CPU in 20 and 32, High CPU in 32 and 62)
	Power and Option Rack	JEPMC-BU330□-E	□: Number of slots: 4: 1 slot DC, 3: 3 slots DC, 2: 8 slots DC, 1: 8 slots AC

MECHATROLINK-II Network Components			
Description	Part Number	Notes	
MP2300Siec	Controller	PMC-U-MP23S □□	without I/O module
		PMC-U-MP23S □□L1	with factory installed LIO-01
		PMC-U-MP23S □□L2	with factory installed LIO-02
MP2310iec	Controller	PMC-U-MP231 □□	without I/O module

□□: Maximum number of MECHATROLINK Axes: 04:4 • 08: 8 • 16:16

MECHATROLINK-II Network Components			
Description	Part Number	Notes	
MP2600iec	Controller/SERVOPACK	SGDV□□□□E1A002000300	□□□□: denotes output capacity and voltage of Σ-V SERVOPACK

MECHATROLINK-III Network Components			
Description	Part Number	Notes	
Software	MotionWorks® IEC Express	PDE-U-IE□Sx	□: Software Version: 2:2 - 3:3 x: License Type: E: Electronic
	MotionWorks IEC Pro	PDE-U-IE□Px	□: Software Version: 2:2 - 3:3 x: License Type: E: Electronic • H: Floating License
	MotionWorks IEC OPC Server	PDE-U-OP□Px	□: Software Version: P:1 - 2:2 x: Licenses: A:1 • B:5 • C:10 • D:20 • E: Electronic Electronic license only available for version 2 of OPC Server
Option Cards (for MP3200iec, MP3300iec, MP2300Siec, MP2310iec)	JAPMC-AN2300	Analog Inputs (AI-01)	(8) channels; +/- 10V @ 16-bit resolution @ 20kΩ or 4-20mA @ 15-bit @ 250Ω
	JAPMC-AN2310	Analog Outputs (AO-01)	(4) channels; +/- 10V @16-bit resolution; 5mA max load current
	JAPMC-DO2300	Output Module (DO-01)	(64) 24VDC sinking outputs; IOmA/output
	JAPMC-IO2300-E	I/O Module (LIO-01)	(16) 24VDC sinking or sourcing inputs; (16) 24VDC sinking outputs; IOmA/output; (1) Encoder Counter; A/B/C channels; differential; latch response time varies based on input used; max frequency 4MHz
	JAPMC-IO2301-E	I/O Module (LIO-02)	(16) 24VDC sinking or sourcing inputs; (16) 24VDC sourcing outputs; IOmA/output; (1) Encoder Counter; A/B/C channels; differential; latch response time varies based on input used; max frequency 4MHz
	JAPMC-IO2303	I/O Module (LIO-04)	(32) 24VDC sinking or sourcing inputs; (32) 24VDC sinking outputs; IOmA/output
	JAPMC-IO2304	I/O Module (LIO-05)	(32) 24VDC sinking or sourcing inputs; (32) 24VDC sourcing outputs; 100mA/output
	JAPMC-IO2305-E	Multi-Function (LIO-06) I/O Option Module	LIO-06 - (8) 24VDC sinking or sourcing inputs; (8) 24 VDC sinking outputs; 100mA/output; (1) Encoder Counter; A/B/C channels; differential; (1) Analog input -10 to +10V 16 bits; (1) Analog Output -10 to +10V 16 bits
	JAPMC-CM2301-E	Communications Option (28IF-Y1)	(1) Ethernet port 10 MBit; (1) RS232 port
	Terminal Block Conversion Kits	CBK-U-MP2A-□□	For L10-01/02
CBK-U-MP2B-□□		For LIO-04/05/06/ MP2600iec	
SBK-U-VBA-□□		For SGD Servo Amp- CN1	



# VIPA SLIO I/O

If you've wished that Input/Output could be **FASTER** and **EASIER**, VIPA SLIO is for you. Yaskawa's new decentralized I/O system is full of features that make connection simpler and I/O function more efficient.

### Easy Web Interface

SLIO diagnostic and status information is accessible through a web interface, linking a standard browser to any EtherNet/IP or Modbus TCP fieldbus module.

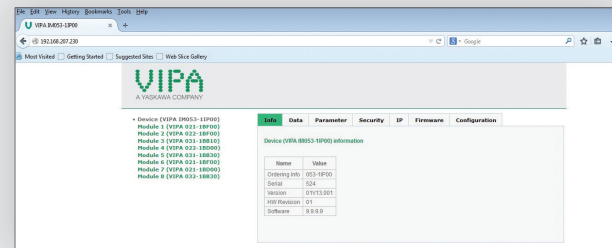

### High Speed Backplane Bus

Achieve reaction times as fast as 20 microseconds with VIPA SLIO's high speed backplane bus. Connect as many as 64 modules at a time, while maintaining speeds up to 48 Mbit/s.



### One-touch Hardware Configurator

VIPA SLIO puts an end to hours of tedious manual I/O configuration. The MotionWorks IEC VIPA SLIO Hardware Configurator sets up a complete I/O system with the touch of a single button.

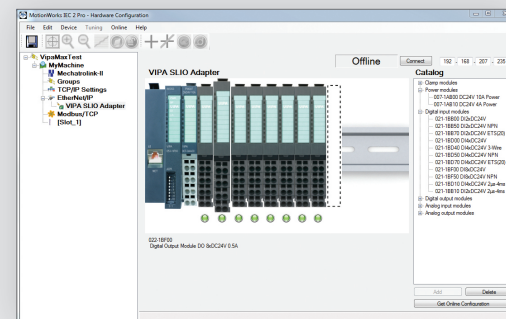

### Installer Friendly Design

Engineered for error-free installation, SLIO can be installed by an average technician without consulting a machine designer or installation engineer.

- Easy, safe assembly with no tools required
- Staircase-shaped wiring level saves space, eases connection
- Clamp terminal assignment is clearly printed on each module
- Labeling strips clearly indicate module function, replace easily after a reconfiguration

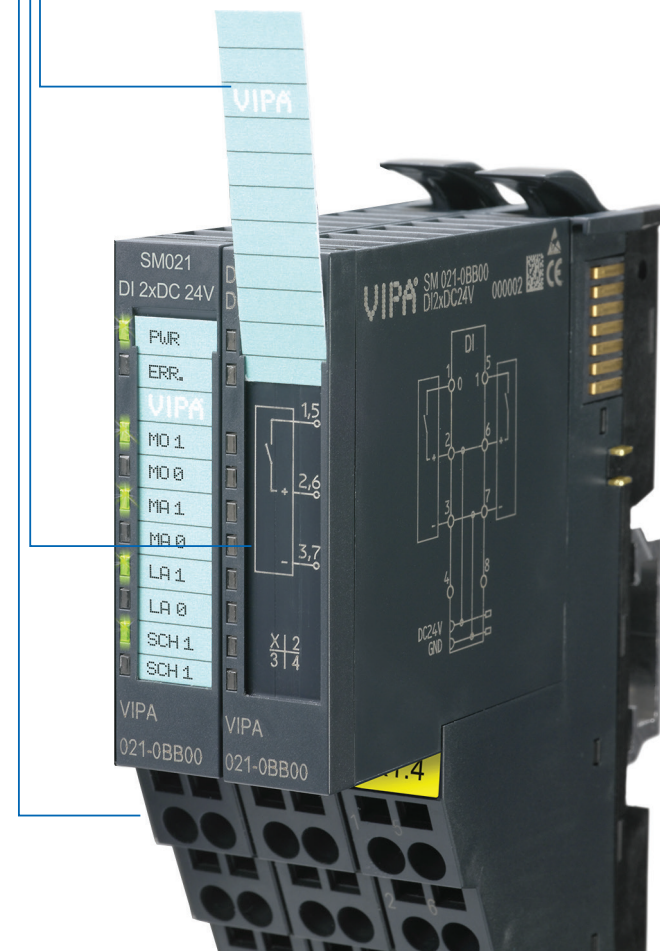

Compact

Intelligent

Flexible

The SLIO system is designed for customers who want to modularize and standardize, yet retain a sense of flexibility. SLIO can help reduce setup time and minimize user errors.

### Reconfigure Without Rewiring

Updating or amending a SLIO system is as easy as removing an existing module and snapping in a new one. System functions can be changed without removing the wiring from the contact block.

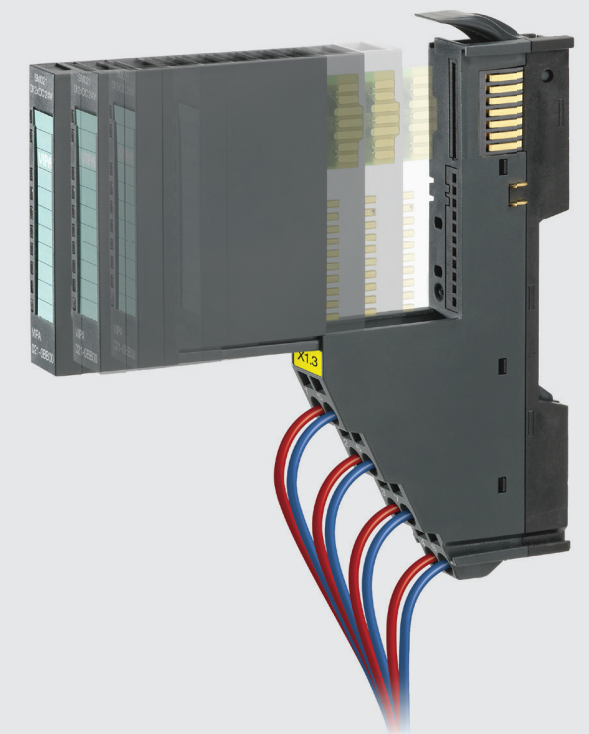

# VIPA SLIO I/O

## Modular Construction for Quick Assembly

**Compact:** Width 12.9 mm, height 109 mm, depth 76.5 mm

**Standardized:** Direct mounting on 35 mm standard profile rail

**Extendable:** The flexible design of SLIO makes it easy to expand as needed; add up to 64 signal and function modules per interface.

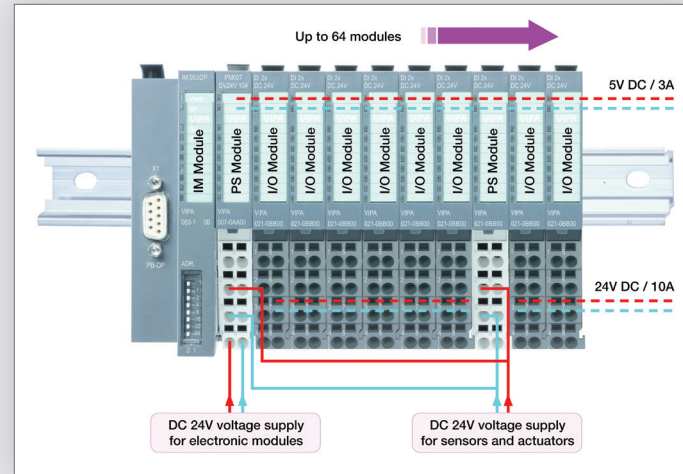

## Interchangeable Function Modules

Choose from 120+ interchangeable signal and function modules, ready to snap into an existing contact block for instant reconfiguration to a new function.

- Analog and digital inputs and outputs
- Communication processor modules
- Coupler modules
- Potential distributor modules
- Power modules
- Temperature modules
- Future modules add tomorrow's functions with the same snap-in interconnection

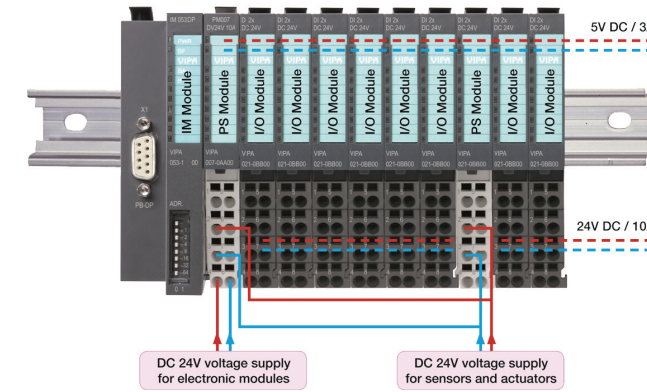
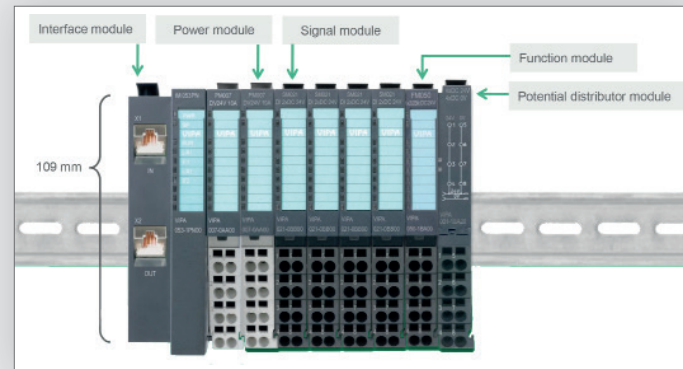

## Modules Supported by MotionWorks® IEC

Fieldbus Module			
EtherNet/IP, 10 A (3 A bus supply)			

Power Modules			
DC 24 V, 10 A			
DC 24 V, 4 A (2 A bus supply)			

Digital Input	2X	4X	8X
DC 24 V	•	•	•
DC 24 V (2 us to 4 ms)	•	•	
DC 24 V (3 wire)		•	
DC 24 V (NPN)	•	•	•

Digital Output	2X	4X	8X
DC 24 V, 0.5 A	•	•	•
DC 24 V, 2 A	•	•	
DC 24 V, 0.5 A (NPN)	•	•	•
DC 24 V, 0.5 A (PWM)	•		
DC 30 V/AC 230 V/3 A (Relay)	•	•	

Analog Input	1X	2X	4X
0 to 10 V, 12 Bit		•	•
0 (4) to 20 mA, 12 Bit		•	•
0 (4) to 20 mA (2 wire), 12 Bit		•	
+/- 10 V, 12 Bit		•	•
Thermocouple, 16 Bit		•	
Ohm Resistance, 16 Bit			•
0 to 10 V, 16 Bit		•	•
0 (4) to 20 mA, 16 Bit		•	•
+/- 10 V, 16 Bit		•	

Analog Output	1X	2X	4X
0 to 10 V, 12 Bit		•	•
0 (4) to 20 mA, 12 Bit		•	•
+/- 10 V, 12 Bit		•	•
0 to 10 V, 16 Bit		•	•
+/- 10 V, 16 Bit		•	•



# Sigma Series Servo Systems



## Ready for the Next Revolution

Your next-generation machine needs more flexibility, easier operation, greater compactness and a lower cost than ever before. To achieve it, you need tomorrow's servo systems. And you need them today.

### The Future Challenge

The high expectations continue long after your machine leaves the drawing board. You'll also need superior servo reliability and years of consistent performance, plus support that sustains your user through years ... or maybe even decades ... of successful production.

#### What if ...

- Your machine could become mechanically simpler, yet also more flexible in the way it functions?
- You could cut the turnaround time in half to commission a new machine?
- You could build a quieter, more efficient machine that always delivers optimal performance?

### Sigma Series: More Built-In Tuning Power

We've packed 25 years of innovation and five generations of servo expertise into our Sigma Series tuning features. The complete package works together to deliver higher speed, greater precision and faster throughput than any servo on the market.

#### Tuning-less Mode

Every Sigma Series SERVOPACK is equipped with a tuning-less function that is enabled from the moment you pull it out of the box. This function allows the amplifier to detect load inertia and automatically adjust servo gains at the update rate of the position loop (a lightning fast 62.5 microseconds). You may never need to tune a Yaskawa servo; not at installation and never again over years of precise, productive operation.

#### Vibration Suppression

Sigma Series SERVOPACKs neutralize vibration, both from the motor's motion artifacts and from resonances within the machine. It detects actual vibration frequencies and cancels them out of the motion command, creating a new machine cycle that is quicker, quieter and more efficient.



Without Vibration Suppression

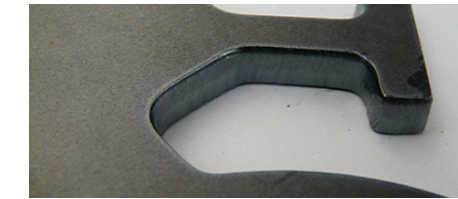

With Vibration Suppression

#### Fight friction, resonance, ripples

Every Sigma Series SERVOPACK is equipped with a complete set of compensation algorithms that virtually eliminate the mechanical impediments which rob a servo of speed, accuracy and smoothness of movement.

- Anti-resonance compensation counteracts the effects of a machine's natural mechanical resonances
- Ripple compensation eliminates the oscillations caused by motor cogging and other motor-based vibration effects
- Friction model compensation automatically corrects for changes in machine operation caused by component wear and other friction effects over time

#### Better Noise Protection

Sigma Series servos are equipped with nine discrete filters to protect against electrical noise, vibration and resonance. The result is more reliable performance, faster response and greater accuracy despite long cable runs, noisy equipment and everyday variations in a machine's mechanical condition.



**Simplify your machine design while improving its overall effectiveness.**



# Packed with Performance

## More torque in less space, for an easier fit in your tightest application

- Yaskawa's segmented stator core design and automated winding techniques pack nearly twice the copper into the stator gap, for much more torque output from every square millimeter of space
- Encapsulated windings prevent shorts between windings, improving heat dissipation
- Precise machining is used to minimize the air gap between rotor magnets and stator windings, for higher running torque and reduced cogging torque
- By reducing the space taken up by the end turns of the winding, overall motor length is significantly reduced
- Neodymium-Iron-Boron rotor magnets optimize flux density in the motor

## Eliminate Mechanical Breakdowns

Simplify your machine's design, decrease part counts and cut assembly time by replacing mechanical linkages with reliable, flexible servo control.

- Designed to accommodate up to a 30:1 inertia mismatch
- Reduce gearbox size, or eliminate gearboxes altogether
- Eliminate maintenance points in machinery and improve safety

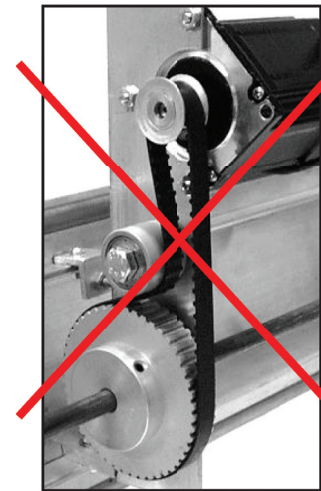

## 7 Sigma Advantages

The new generation of Sigma Series servo motors offer power, precision and reliability unmatched by anything in the automation industry. Better still, the newest Sigma-7 motors are completely compatible with Yaskawa's industry-leading Sigma-5 products. An easy replacement can lead to an instant boost in machine productivity.

1 20% more compact in size, for an easier fit in more applications

2 16x better resolution radically improves positional accuracy

3 Nearly double the bandwidth yields faster speed, more throughput

4 New thermal sensors detect application problems before they affect motor life

5 Withstands ambient temperatures to 60°C for trustworthy performance in extreme environments

6 High-altitude friendly with full function assured at elevations of 2000 meters and above

7 IP67 rated for total protection against dust and the effects of water immersion to a depth of 1 m





# Direct Drive Servo Motors

## Reduce Downtime

By eliminating gear reduction and creating a direct coupling to the machine load, direct drive motors simplify your machine's design. Eliminating transmission components leads to fewer breakdowns and long-term reliability you can trust.

## Increase Performance

Direct drive motors get rid of the inefficiencies caused by mechanical transmission components that wear over time. Say goodbye to mechanical backlash as well. As compliance is reduced, the responsiveness of the servo system can be dramatically improved.

## Reduce Size and Cost

Directly coupling a compact direct drive servo motor to your machine load will save physical space, which can lead to a more compact machine. When precision gearheads and other transmission components are gone, the cost of your machine will go down as well.

## Boost the Quality of Your Design

Implementing direct drive motor technology leads to a host of improvements in the quality of a machine's design.

- Less audible noise
- Reduced need for preventive maintenance of mechanical transmissions
- Overall efficiency and performance can be significantly increased, leading to a lower long term cost



## Typical Applications

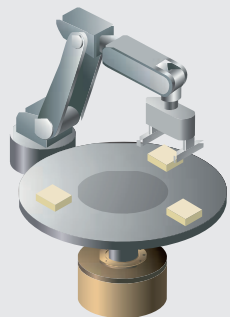

Rotary Table

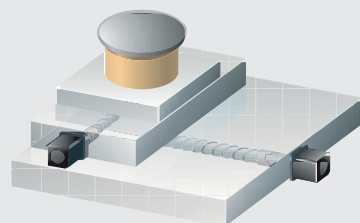

XY Table



Semiconductor Handling Robot

# Linear Servo Motors

Yaskawa linear servo motors replace the backlash, friction, inertia and wear of mechanical linkages with smooth, precise, high performance linear motion in a compact footprint. Any product in the Yaskawa linear servo family offers plug-and-play connection with Sigma-7 and Sigma-5 series SERVOPACK amplifiers, using automatic motor recognition and serial encoder technology to make implementation trouble free.

**Yaskawa offers a full range of linear servo products that are designed to handle the most demanding applications**

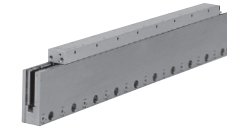

## SGLG Coreless

Achieve smooth linear motion with an ironless design that eliminates motor cogging.

- 200 V windings
- 40 to 3000 N of peak force
- Standard and high force magnetic ways
- Zero cogging for minimal force ripple

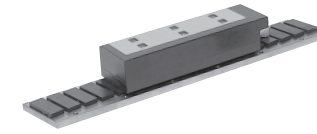

## SGLF2 Iron Core

Second generation iron core design that delivers high force and speed in a compact form.

- 200 V or 400 V windings
- 135 to 7560 N of peak force
- 5 m/s peak speed

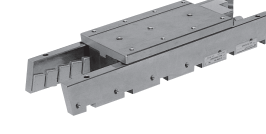

## SGLT Dual Magnet Iron Core

An iron core design featuring dual magnets, producing high output in a compact footprint.

- 200 V or 400 V windings
- 380 to 7500 N of peak force
- 5 m/s peak speed
- Very little cogging

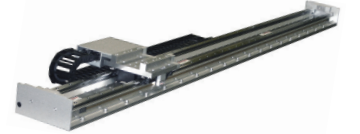

## SGT Sigma Trac

A ready-to-implement solution, including every element needed for plug-and-play linear motion.

- Factory assembled, integrated stage
- 200 or 400 V windings
- Stroke lengths from 80 mm to 2 m
- 220 to 1200 N of peak force
- Sub-micron repeatability

## Need for Speed?

If your application requires linear speeds and accelerations that go beyond the capabilities of traditional mechanisms, take a look at Yaskawa linear motors.

## More Performance

Direct coupling to the machine load eliminates mechanical linkages, significantly improving responsiveness and reliability.

## Engineered Solutions

The Sigma Trac linear motor stage reduces machine design complexity and commissioning time.

# Sigma Series Servopacks



## A "Smarter" Amplifier for Extra Productivity

Every Yaskawa servo motor has a companion SERVOPACK amplifier, with built-in control software that simplifies setup, fine tunes performance and boosts automation efficiency.

### The Yaskawa Tuning Suite

Yaskawa equips each SERVOPACK with a suite of software commissioning and tuning tools, designed to achieve full functioning right out of the box. This superior performance continues in spite of all the vibration, resonance, friction and noise that a modern automated machine can dish out.

### Get rid of effects that steal away performance

Unwanted mechanical effects rob a servo system of the quick, smooth and precise movement you need. Yaskawa SERVOPACKs are equipped with suppression features that automatically eliminate harmful artifacts.

#### Vibration

Machine vibrations are eliminated by Yaskawa Vibration Suppression, which samples your equipment's natural oscillations and uses compensating frequencies to cancel them out.

#### Ripples

Motor cogging effects are removed by Ripple Compensation, an especially important effect for systems that require minimum settling time and exceptionally precise positioning.

#### Resonance

Sigma-7 amplifiers have twice as many anti-resonance filters to more effectively repress a servo system's natural medium-frequency resonances.

#### Friction

Coulomb friction and viscosity-related variables are effectively addressed by Friction Model Compensation, which effectively elicits smooth start-up action in low speed or high rigidity machines.

#### Electromagnetic interference

The number of interference filters has been increased by 225% to counteract losses caused by data dropouts, EMI interference and artifacts from long cable runs.

### Tuning-Less Function

#### Get up and running quickly

From Day One, the tuning-less function automatically compensates for mismatches in load to rotor inertia up to 30:1.

Setting time:  
**40 ms**  
range

### Advanced Autotuning

#### Minimize setting time Maximize smooth motion

Advanced auto tuning automatically adjusts nearly 20 gain and filter parameters to cancel vibration, rippling, friction and resonance.

Setting time:  
**4 ms**  
range

### One Parameter Tuning

#### Precise user-driven adjustment

Improve your machine's performance even further with easy fine tuning adjustments that won't throw off your existing operating parameters.

Setting time:  
**0 to 4 ms**  
range



**SERVOPACKs with features that amp up productivity**



# Feature-Packed For Your Machine

A choice of open protocol, high speed deterministic digital networks



- Used with our full line of IEC61131-3 Motion Controllers
- Superior noise immunity in challenging industrial environments
- Retry function minimizes data drop-outs

OR



- Adheres to CoE device profile (CiA402)
- Distributed clock for synchronized operation
- Variety of system architectures (cascade, line, star, ring)

## Functional Safety

A Safe Torque Off (STO) circuit is standard equipment in every SERVOPACK. Safety functions SS1 (Safe Stop 1), SS2 (Safe Stop 2), and SLS (Safe Limited Speed) are integrated with the selection of an optional safety module.

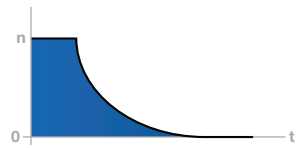

Safe Torque Off (STO)

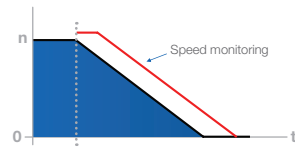

Safe Stop 1 (SS1)

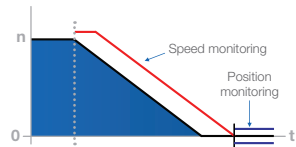

Safe Stop 2 (SS2)

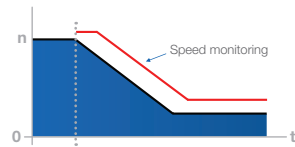

Safely Limited Stop (SLS)

## Primary Feedback Option

- 20 Bit serial absolute encoder
- Motor data stored in the encoder
- Simplified cable design

## Secondary Feedback Option (Full Closed Loop Control)

- Allows user to close position loop around secondary feedback device near the load
- Helps eliminate the effects of mechanical compliance and thermal variances
- Delivers more precise control and improved machine performance

## SGD7S Single Axis Amplifier

- 100 V, 200 V and 400 V operation
- 50 W-15 kW operating range
- Control interface options: EtherCAT, MECHATROLINK, analog



## SGD7W Dual Axis Amplifier

- Control two servo axes with one amplifier
- Lower cost, component count
- 200 V or 400 V operation
- Conserves cabinet space
- Regenerative power feature conserves energy



## SigmaLogic™ with EtherNet/IP

- Add On Instructions (AOIs) for use with Rockwell PLCs
- Dual EtherNet/IP ports onboard
- Perform automation functions without learning new software
- Basic point to point moves, blended speed moves, homing, jogging, electronic gearing



## MP2600iec Single Axis Controller

- Motion Controller and amplifier in one device
- IEC61131-3 compatibility for predictable behavior
- MotionWorks® IEC software provides scalability between single and multi-axis control
- EtherNet/IP, Modbus TCP connectivity links to most PLCs and HMIs
- A built-in web server offers diagnostic info without special software



## Wide Range

A power range from 10 W to 55 kW, with 100-480 VAC operation.

## Scalable as Needs Change

Switching from a single axis controller to a multi axis model is easier, due to the fact that programming from a single axis SERVOPACK can be used in any Yaskawa multi-axis controller without revision.

## Simple Commissioning

An automatic motor recognition function uses data resident within Yaskawa servo motors to configure a SERVOPACK for safe and effective operation.

# Standard Rotary

The world's largest manufacturer of servo motors brings 25 years of design innovation into each Sigma-7 rotary servo. Choose from a wide range of sizes, speeds and torque ratings, then add an amplifier and an MPiEc controller to create a complete motion automation system.

100/200 V				400 V			
Low Inertia		Medium Inertia		Low Inertia		Medium Inertia	
							
<b>SGMMV</b>	3W-30W	<b>SGM7P</b>	100W-1.5kW	<b>SGM7A</b>	200W-5kW	<b>SGM7J</b>	200W-1.5kW
<b>SGM7A</b>	50W-7kW	<b>SGM7J</b>	50W-750W	<b>SGM7G</b>	300W-15kW	<b>SGMV</b>	22kW-55kW

Servopacks			
1 Axis		2 Axis	
			
<b>SGD7S</b>	50W-15kW	<b>SGD7W</b>	200W-1kW/axis
<b>SGD7S</b>	500W-15kW	<b>SGD7W</b>	750W-1.5kW/axis





**Control Interface Options:** EtherCAT, MECHATROLINK  
(Analog 100 V SERVOPACKS available from 50-400W)

**Control Interface Options:** EtherCAT, MECHATROLINK

# Direct Drive Rotary

Direct drive products save space, eliminate backlash and cut component costs, adding extra mechanical strength to stiffen dynamic applications.

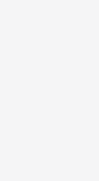
200 V	
	(Iron Core) 4.0-25 Nm rated torque, 600 rpm max speed
	(Coreless) 2.0-200 Nm rated torque, 500 rpm max speed
	(Iron Core) 1.30-240 Nm rated torque, 30-240 rpm max speed



Servopacks			
1 Axis		2 Axis	
			
<b>SGD7S</b>	50W-15kW	<b>SGD7W</b>	200W-1kW/axis

**Control Interface Options:** EtherCAT, MECHATROLINK

**Control Interface Options:** EtherCAT, MECHATROLINK

# Direct Drive Linear

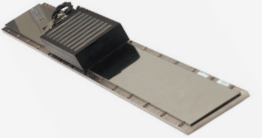
Maximum speed and acceleration for linear motion. Choose from four designs to reduce compliance, replace mechanical linkages and create a better fit for your application.

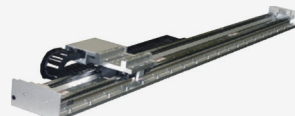
200 V	
400 V Options Also Available	
	(Coreless) 40-3000 N peak force, 5 m/s max speed
	(Iron Core) 135-7560 N peak force, 5 m/s max speed
	(DoubleTrac) 380-7500 N peak force, 5 m/s max speed
	Assembly 1200 N peak force, 5 m/s max speed





## Small Capacity Model Specifications

Rotary Servo Motor Model	Rated Power	Rated Torque	Peak Torque	Rated Speed	Max Speed	Rotor Inertia	SGD7S-□□□□	SGD7S-□□□□	SGD7W-□□□□	SGD7S-□□□□	SGD7W-□□□□		
		Nm	Nm	rpm	rpm		100 VAC	200 VAC	200 VAC	400 VAC	400 VAC		
 SGMMV-A1A	10W	0.0318	0.0955	3000	6000	0.000272	R90F	R90A	1R6A, 2R8A	N/A	N/A		
	20W	0.0637	0.191	3000	6000	0.000466	R90F	R90A	1R6A, 2R8A				
	30W	0.0955	0.286	3000	6000	0.000668	2R1F	1R6A	1R6A, 2R8A				
	50W	0.159	0.557	3000	6000	0.0217	R70F	R70A	1R6A, 2R8A				
 SGM7A	SGM7A-01A	100W	0.318	1.11	3000	6000	0.0337	R90F	R90A	1R6A, 2R8A	N/A		
	SGM7A-C2A	150W	0.477	1.67	3000	6000	0.0458	2R1F	1R6A	1R6A, 2R8A			
	SGM7A-02□	200W	0.637	2.23	3000	6000	0.139	2R1F	1R6A	1R6A, 2R8A		1R9D	2R6D
	SGM7A-04□	400W	1.27	4.46	3000	6000	0.216	2R8F	2R8A	1R6A, 2R8A, 7R6A		1R9D	2R6D, 5R4D
	SGM7A-06A	550W	1.75	6.69	3000	6000	0.315		5R5A	5R5A, 7R6A		N/A	N/A
	SGM7A-08□	600W	1.91	8.36	3000	6000	0.775	N/A	5R5A	5R5A, 7R6A		3R5D	2R6D, 5R4D
	SGM7A-10□	1.0kW	3.18	11.1	3000	6000	0.971		120A	N/A		3R5D	5R4D
	SGM7J-A5A	50W	0.159	0.557	3000	6000	0.0395	R70F	R70A	1R6A, 2R8A		N/A	N/A
SGM7J-01A	100W	0.318	1.11	3000	6000	0.0659	R90F	R90A	1R6A, 2R8A				
SGM7J-C2A	150W	0.477	1.67	3000	6000	0.0915	2R1F	1R6A	1R6A, 2R8A				
SGM7J-02□	200W	0.637	2.23	3000	6000	0.263	2R1F	1R6A	1R6A, 2R8A	1R9D	2R6D		
SGM7J-04□	400W	1.27	4.46	3000	6000	0.486	2R8F	2R8A	1R6A, 2R8A, 7R6A	1R9D	2R6D, 5R4D		
SGM7J-06A	550W	1.91	6.69	3000	6000	0.8		5R5A	5R5A, 7R6A	N/A			
SGM7J-08□	750W	2.39	8.36	3000	6000	1.59	N/A	5R5A	5R5A, 7R6A	3R5D	2R6D, 5R4D		
SGM7J-15D	1.5kW	4.77	14.3	3000	6000	4.02		N/A	N/A	5R4D	5R4D		
 SGM7P	SGM7P-01A	100W	0.318	0.955	3000	6000	0.0592	R90F	R90A	1R6A, 2R8A	N/A	N/A	
	SGM7P-02A	200W	0.637	1.91	3000	6000	0.263	2R8F	2R8A	2R8A, 5R5A, 7R6A			
	SGM7P-04A	400W	1.27	3.82	3000	6000	0.409	2R8F	2R8A	2R8A, 5R5A, 7R6A			
	SGM7P-08A	750W	2.39	7.16	3000	6000	2.1		5R5A	5R5A, 7R6A			
	SGM7P-15A	1.5kW	4.77	14.3	3000	6000	4.02	N/A	120A	N/A			

## Medium/Large Capacity Model Specifications

Rotary Servo Motor Model	Rated Power	Rated Torque	Peak Torque	Rated Speed	Max Speed	Rotor Inertia	SGD7S-□□□□	SGD7S-□□□□	SGD7W-□□□□	
		Nm	Nm	rpm	rpm		100 VAC	400 VAC	400 VAC	
 SGM7A	SGM7A-15□	1.5kW	4.90	14.7	3000	6000	2.00	120A	5R4D	5R4D
	SGM7A-20□	2.0kW	6.36	19.1	3000	6000	2.47	180A	8R4D	
	SGM7A-25□	2.5kW	7.96	23.9	3000	6000	3.19	200A	120D	N/A
	SGM7A-30□	3.0kW	9.80	29.4	3000	6000	7.00	200A	120D	
	SGM7A-40□	4.0kW	12.6	37.8	3000	6000	9.60	330A	170D	
	SGM7A-50□	5.0kW	15.8	47.6	3000	6000	12.3	330A	170D	
	SGM7A-70A	7.0kW	22.3	54.0	3000	6000	12.3	550A	N/A	

## Medium/Large Capacity Model Specifications

Rotary Servo Motor Model	Rated Power	Rated Torque	Peak Torque	Rated Speed	Max Speed	Rotor Inertia	SGD7S-□□□□	SGD7S-□□□□	SGD7W-□□□□	SGDS-□□□□	SGD7W-□□□□	SGDV-□□□□
		Nm	Nm	rpm	rpm		100 VAC	200 VAC	200 VAC	400 VAC	400 VAC	400 VAC
 SGM7G	SGM7G-03A	300W	1.96	5.88	1500	3000	2.48		3R8A	5R5A, 7R6A	N/A	N/A
	SGM7G-05□	450W	2.86	8.92	1500	3000	3.33		3R8A	5R5A, 7R6A	1R9D	2R6D, 5R4D
	SGM7G-09□	850W	5.39	13.8	1500	3000	13.9		7R6A	7R6A	3R5D	5R4D
	SGM7G-13□	1.3kW	8.34	14.2	1500	3000	19.9		120A		5R4D	5R4D
	SGM7G-20□	1.8kW	11.5	28.7	1500	3000	26.0		180A		8R4D	
	SGM7G-30□	2.9kW	18.6	54.0	1500	3000	46.0		330A		120D	N/A
	SGM7G-44□	4.4kW	28.4	71.6	1500	3000	67.5		330A	N/A	170D	
	SGM7G-55□	5.5kW	35.0	102.0	1500	3000	89.0		470A		210D	N/A
	SGM7G-75□	7.5kW	48.0	119	1500	3000	125		550A		260D	
	SGM7G-1A□	11kW	70.0	175	1500	2000	242		590A		280D	
 SGMVV	SGM7G-1E□	15kW	95.4	224	1500	2000	303	N/A	780A		370D	
	SGMVV-2BD□B	22kW	140	350	1500	2000	366					750J
	SGMVV-3ZD□B	30kW	191	478	1500	2000	498					750J
	SGMVV-3GD□B	37kW	236	589	1500	2000	595					101J
	SGMVV-4ED□B	45kW	286	715	1500	2000	1071					131J
	SGMVV-5ED□B	55kW	350	875	1500	2000	1290		N/A	N/A	N/A	131J
	SGMVV-2BD□D	22kW	262	526	800	1300	705					750J
	SGMVV-3ZD□D	30kW	358	752	800	1300	1290					750J
	SGMVV-3GD□D	37kW	442	930	800	1300	1564					101J
	SGMVV-4ED□D	45kW	537	1182	800	1300	1804					131J

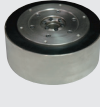
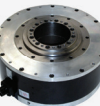

## Direct Drive Rotary Servo Specifications

Rotary Servo Motor Model	Rated Power	Rated Torque	Peak Torque	Rated Speed	Max Speed	Rotor Inertia	SERVOPACK Model: SGD7W-□□□□		
		Nm	Nm	rpm	rpm		100 VAC	200 VAC	
 SGMCS	SGMCS-02B	42W	2.0	6.0	200	500	28.0	2R1F	2R8A
	SGMCS-05B	105W	5.0	15.0	200	500	51.0	2R1F	2R8A
	SGMCS-07B	147W	7.0	21.0	200	500	77.0	2R1F	2R8A
	SGMCS-04C	84W	4.0	12.0	200	500	77.0	2R8F	2R8A
	SGMCS-10C	209W	10.0	30.0	200	400	140	2R8F	2R8A
	SGMCS-14C	293W	14.0	42.0	200	300	220	2R8F	2R8A
	SGMCS-08D	168W	8.0	24.0	200	500	285	2R8F	2R8A
	SGMCS-17D	356W	17.0	51.0	200	350	510	2R8F	2R8A
	SGMCS-25D	393W	25.0	75.0	150	250	750	2R8F	2R8A
	SGMCS-16E	335W	16.0	48.0	200	500	930	2R8F	5R5A
 SGMCS	SGMCS-35E	550W	35.0	105	150	250	1430	2R8F	5R5A
	SGMCS-45M	707W	45.0	135	150	300	388		7R6A
	SGMCS-80M	1.26kW	80.0	240	150	300	627		120A
	SGMCS-80N	1.26kW	80.0	240	150	300	1360		120A
	SGMCS-1AM	1.73kW	110	330	150	300	865	N/A	180A
	SGMCS-1EN	2.36kW	150	450	150	250	2470		200A
SGMCS-2ZN	3.14kW	200	600	150	250	3060		200A	

## Direct Drive Rotary Servo Specifications

Rotary Servo Motor Model	Rated Power	Rated Torque	Peak Torque	Rated Speed	Max Speed	Rotor Inertia	SERVOPACK Model: SGD7S-□□□□		
		Nm	Nm	rpm	rpm	kg-cm <sup>2</sup>	100 VAC	200 VAC	
 <p><b>SGM7F</b> Medium Capacity</p>	SGM7F-02	63	2.00	6.00	300	600	8.04	2R1F	2R8A
	SGM7F-04	126	4.00	12.0	300	600	16.2	2R8F	2R8A
	SGM7F-05	157	5.00	15.0	300	600	14.5	2R1F	2R8A
	SGM7F-07	220	7.00	21.0	300	600	19.3	2R8F	2R8A
	SGM7F-08	251	8.00	24.0	300	600	56.5	2R8F	2R8A
	SGM7F-10	314	10.0	30.0	300	600	25.2	2R8F	2R8A
	SGM7F-14	440	14.0	42.0	300	600	36.9		5R5A
	SGM7F-16	503	16.0	48.0	300	600	178		5R5A
	SGM7F-17	534	17.0	51.0	300	600	78.5	N/A	5R5A
	SGM7F-25	785	25.0	75.0	300	500	111		7R6A
	SGM7F-35	1100	35.0	105	300	400	276		120A
	 <p><b>SGM7D</b> Medium Capacity</p>	SGM7D-01G	16	1.30	4.00	120	150	55	2R8F
SGM7D-02K		52	2.06	5.00	240	360	60	2R8F	2R8A
SGM7D-03H		38	3.00	4.00	120	120	25	2R8F	2R8A
SGM7D-05G		63	5.00	6.00	120	150	75	2R8F	2R8A
SGM7D-06J		75	6.00	8.00	120	144	150	N/A	120A
SGM7D-06K		151	6.00	10.0	240	360	70	2R8F	2R8A
SGM7D-06L		113	6.00	10.0	180	216	220	2R8F	2R8A
SGM7D-08G		101	8.00	15.0	120	144	120	N/A	120A
SGM7D-08K		201	8.00	15.0	240	360	80	2R8F	2R8A
SGM7D-09J		113	9.00	15.0	120	144	210	N/A	120A
SGM7D-12L		226	12.0	20.0	180	216	220	2R8F	2R8A
SGM7D-18G		226	18.0	30.0	120	144	150		120A
SGM7D-18J		226	18.0	30.0	120	144	240		120A
SGM7D-20J		251	20.0	45.0	120	144	260		120A
SGM7D-24G		302	24.0	45.0	120	144	190		120A
SGM7D-28I		264	28.0	50.0	90	108	1800		120A
SGM7D-30F		188	30.0	50.0	60	72	960		120A
SGM7D-30L		565	30.0	40.0	180	216	370		120A
SGM7D-34G		320	34.0	60.0	90	144	230		120A
SGM7D-38J		358	38.0	60.0	90	144	330		120A
SGM7D-45G		565	45.0	75.0	120	144	270	N/A	120A
SGM7D-58F		364	58.0	100	60	72	1190		120A
SGM7D-70I		440	70.0	100	60	72	2000		120A
SGM7D-90F		565	90.0	150	60	72	1420		120A
SGM7D-1ZI		628	100	150	60	72	2300		120A
SGM7D-1AF		691	110	200	60	72	1670		120A
SGM7D-1CI		817	130	200	60	72	2850		120A
SGM7D-2BI		691	220	300	30	60	3400		120A
SGM7D-2DI		754	240	400	30	48	4000		120A

## Linear Servo Specifications

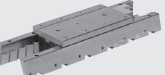
Linear Servo Motor Coil Model	Rated Force	Peak Force	Rated Speed	Peak Speed	Moving Coil Mass	SERVOPACK Model: SGD□V-□□□□			
	N	N	m/s	m/s	kg	100 VAC	200 VAC	400 VAC	
 <p><b>SGLFW2</b> Iron Core Type</p>	SGLFW2-30□070A□	45	135	4.0	5.0	0.5	2R1F	1R6A	1R9D
	SGLFW2-30□120A□	90	270	4.0	5.0	0.9	2R1F	1R6A	1R9D
	SGLFW2-30□230A□	180	540	4.0	5.0	1.7	2R8F	3R8A	1R9D
	SGLFW2-45□200A□	280	840	4.0	4.5	2.9		5R5A	3R5D
	SGLFW2-45□380A□	560	1680	4.0	4.5	5.5		180A	8R4D
	SGLFW2-90□200A□	560	1680	4.0	4.0	5.3		120A	5R4D
	SGLFW2-90□380A□	1120	3360	4.0	4.0	10.1	N/A	200A	120D
	SGLFW2-90□560A□	1680	5040	4.0	4.0	14.9		330A	170D
	SGLFW2-1D□380A□	1680	5040	2.0	2.5	14.6		200A	170D
	SGLFW2-1D□560A□	2520	7560	2.0	2.5	21.5		330A	260D
 <p><b>SGLGW</b> Coreless Type with Standard Magneticway</p>	SGLGW-30A050CP	12.5	40	1.5	5	0.10	R70F	R70A	
	SGLGW-30A080CP	25	80	1.5	5	0.15	R90F	R90A	
	SGLGW-40A140CP	47	140	2.0	5	0.34	R90F	R90A	
	SGLGW-40A253CP	93	280	2.0	5	0.60	2R1F	1R6A	
	SGLGW-40A365CP	140	420	2.0	5	0.87	2R8F	2R8A	
	SGLGW-60A140CP	70	220	2.3	4.8	0.42	2R1F	1R6A	
	SGLGW-60A253CP	140	440	2.3	4.8	0.76	2R8F	2R8A	
	SGLGW-60A365CP	210	660	2.3	4.8	1.1		5R5A	
	SGLGW-90A200CP	325	1300	1.8	4	2.2	N/A	120A	N/A
	SGLGW-90A370CP	550	2200	1.5	4	3.6		180A	
 <p><b>SGLGW</b> Coreless Type with High-Force Magneticway</p>	SGLGW-90A535CP	750	3000	1.5	4	4.9		200A	
	SGLGW-40A140CP	57	230	1.0	4.2	0.34	2R1F	1R6A	
	SGLGW-60A140CP	85	360	1.0	4.2	4.2	2R1F	1R6A	
	SGLGW-40A253CP	114	460	1.0	4.2	0.60	2R8F	2R8A	
	SGLGW-40A365CP	171	690	1.0	4.2	0.87		3R8A	
	SGLGW-60A253CP	170	720	1.0	4.2	0.76		3R8A	
	SGLGW-60A365CP	255	1080	1.0	4.2	1.1		7R6A	
	SGLTW-20A170AP	130	380	3.0	5.0	2.5		3R8A	N/A
	SGLTW-35A170AP	220	660	2.5	5.0	3.7		5R5A	
	SGLTW-35□170HP	300	600	2.5	4.8	4.9		5R5A	3R5D
 <p><b>SGLTW</b> Dual Magnet Iron Core Type</p>	SGLTW-50□170HP	450	900	2.0	3.2	6.0		5R5A	3R5D
	SGLTW-20A320AP	250	760	3.0	5.0	4.6		7R6A	
	SGLTW-20A460AP	380	1140	3.0	5.0	6.7	N/A	120A	N/A
	SGLTW-35A320AP	440	1320	2.5	5.0	6.8		120A	
	SGLTW-35□320HP	600	1200	2.0	4.8	8.8		120A	8R4D
	SGLTW-50□320HP	900	1800	2.0	3.1	11.0		120A	8R4D
	SGLTW-35A460AP	670	2000	2.5	5.0	10.0		180A	N/A
	SGLTW-40□400BP	670	2600	1.5	3.1	15.0		180A	120D
	SGLTW-40□600BP	1000	4000	1.5	3.1	23.0		330A	170D
	SGLTW-80□400BP	1300	5000	1.5	2.5	24.0		330A	170D
 <p><b>Σ-TRAC</b> Linear Motor Stage</p>	SGLTW-80□600BP	2000	7500	1.5	2.5	35.0		550A	260D
	SGT1F31-□□□AR20-04	80	220	4.6	5.0	4.3	2R1F	1R6A	
	SGT1F41-□□□AR20-04	160	440	5.0	5.0	6.6		3R8A	N/A
	SGT1F91-□□□AR20-04	280	600	4.2	5.0	8.5	N/A	5R5A	
	SGT1FA1-□□□AR20-04	560	1200	4.4	5.0	14.5		120A	
	SGT1FD1-□□□AR20-04	80	220	4.6	5.0	4.3			1R9D
	SGT1FE1-□□□AR20-04	160	440	5.0	5.0	6.6	N/A	N/A	1R9D
	SGT1FF1-□□□AR20-04	280	600	4.2	5.0	8.5			3R5D
	SGT1FG1-□□□AR20-04	560	1200	4.4	5.0	14.5			5R4D



# Engineered Solutions

Turning Servos into Services

## You Need Solutions

You need to bring new designs to market in months or weeks instead of years. At the same time, you no longer have the luxury of a large staff of engineers or the help of in-house automation experts.

### The Challenge: Expertise

Design and support of automation is a challenge to your resources. Your automation design must be effective immediately, and there's no room for downtime, lost production or support difficulties down the line.

#### What if ...

- You could add automation engineers to your staff at the exact moment you need them?
- You could hand off responsibility for designing and supporting your machine automation to someone you trusted?
- You could keep your engineering staff focused on areas where your company truly adds value?

**More than 75% of manufacturers report a moderate to severe shortage of skilled resources\***

### A Portfolio of Services

The experts at Yaskawa function as an extension of your engineering staff to create elegant, reliable automation.

We begin by understanding your application and process, the results you need to achieve, your time frame and cost structure. This level of understanding is what sets Yaskawa Engineered Systems apart, and makes us Capable of More.

#### Motion Application Services

Yaskawa's engineering expertise can be applied to any stage of machine development.

- System Concept Design
- Component Selection
- Electrical Design
- Mechatronic Design
- Machine Start-up
- Programming
- Optimization
- Troubleshooting

### Software Development

Make Yaskawa's programming staff your software design and development team, and get engineers who truly understand the impact of software design on real-world machine operation.

### Engineered Systems

Yaskawa's Engineered Systems group offers a range of products and services including complete machine retrofits, enclosure design/manufacturing and electromechanical assembly design, plus integration of Yaskawa technology into a "purpose built" mechanism for your application.

**Purpose-Built Mechanisms:** Yaskawa integrates servo technology into complete assemblies, including flexures, four-bar linkages, integrated ballscrew motors, and direct drive systems. Each mechanism is tested and characterized, with a documented, serialized fingerprint and a full warranty provided for each assembly. Yaskawa will continue to service and support each assembly for the entire life of your machine.

**Systems Engineering:** Yaskawa Engineered Systems provides valuable engineering expertise, including:

- Complete electrical enclosures and custom cables
- Retrofits and training for legacy equipment
- Upgrading legacy controls/servos to the latest technologies
- 365 days a year, 24-hour support

Yaskawa works with you during the entire cycle of a systems project, from defining scope and schedule to specifying components, electrical and software design, installation and line start-up. Our engineering expertise extends to support robot, servo, PLC, VFD, and controller products from Yaskawa and a wide variety of other suppliers.

\*2014 Manufacturing Skills and Training Study, The Manufacturing Institute (affiliate of the National Association of Manufacturers.) A copy of the report is available on request.



Yaskawa is the leading global manufacturer of low and medium voltage variable frequency drives, servo systems, machine controllers and industrial robots. Our standard products, as well as tailor-made solutions, are well known and have a high reputation for outstanding quality and reliability.