



## Profile Rail Linear Guides

500 Series Ball Profile Rail, 500 Series Roller Profile Rail,  
400 Series Profile Rail, AccuMini, MicroGuide, T-Series



*Linear Motion. Optimized.™*

## Thomson – the Choice for Optimized Motion Solutions

Often the ideal design solution is not about finding the fastest, sturdiest, most accurate or even the least expensive option. Rather, the ideal solution is the optimal balance of performance, life and cost.

### The Best Positioned Supplier of Mechanical Motion Technology

Thomson has several advantages that makes us the supplier of choice for motion control technology.

- Thomson own the broadest standard product offering of mechanical motion technologies in the industry.
- Modified versions of standard product or white sheet design solutions are routine for us.
- Choose Thomson and gain access to over 70 years of global application experience in industries including packaging, factory automation, material handling, medical, clean energy, printing, automotive, machine tool, aerospace and defense.
- As part of Fortive Corporation, we are financially strong and unique in our ability to bring together control, drive, motor, power transmission and precision linear motion technologies.

### A Name You Can Trust

A wealth of product and application information as well as 3D models, software tools, our distributor locator and global contact information is available at [www.thomsonlinear.com](http://www.thomsonlinear.com). For assistance in Europe, contact us at +44 1271 334 500 or e-mail us at [sales.europe@thomsonlinear.com](mailto:sales.europe@thomsonlinear.com).

Talk to us early in the design process to see how Thomson can help identify the optimal balance of performance, life and cost for your next application. And, call us or any of our 2000+ distribution partners around the world for fast delivery of replacement parts.

### The Fortive Business System

The Fortive Business System (FBS) was established to increase the value we bring to customers. It is a mature and successful set of tools we use daily to continually improve manufacturing operations and product development processes. FBS is based on the principles of Kaizen which continuously and aggressively eliminate waste in every aspect of our business. FBS focuses the entire organization on achieving breakthrough results that create competitive advantages in quality, delivery and performance – advantages that are passed on to you. Through these advantages Thomson is able to provide you faster times to market as well as unsurpassed product selection, service, reliability and productivity.

### Local Support Around the Globe

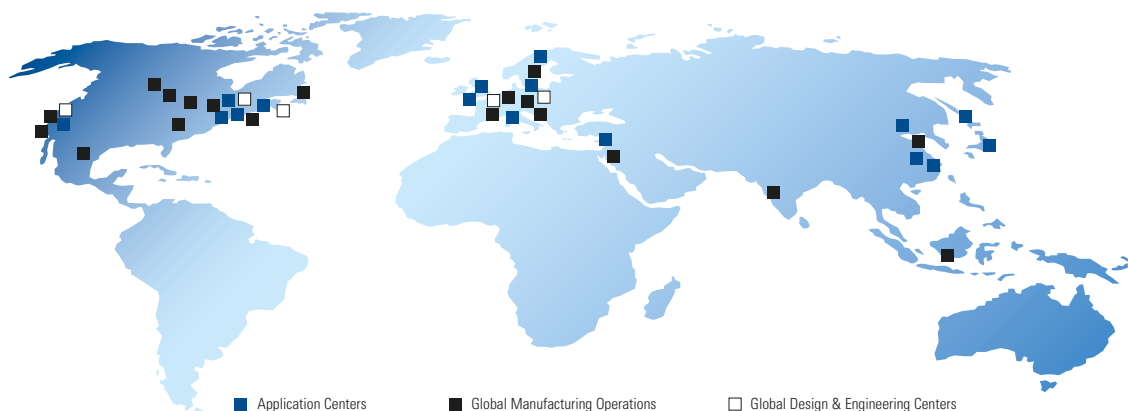
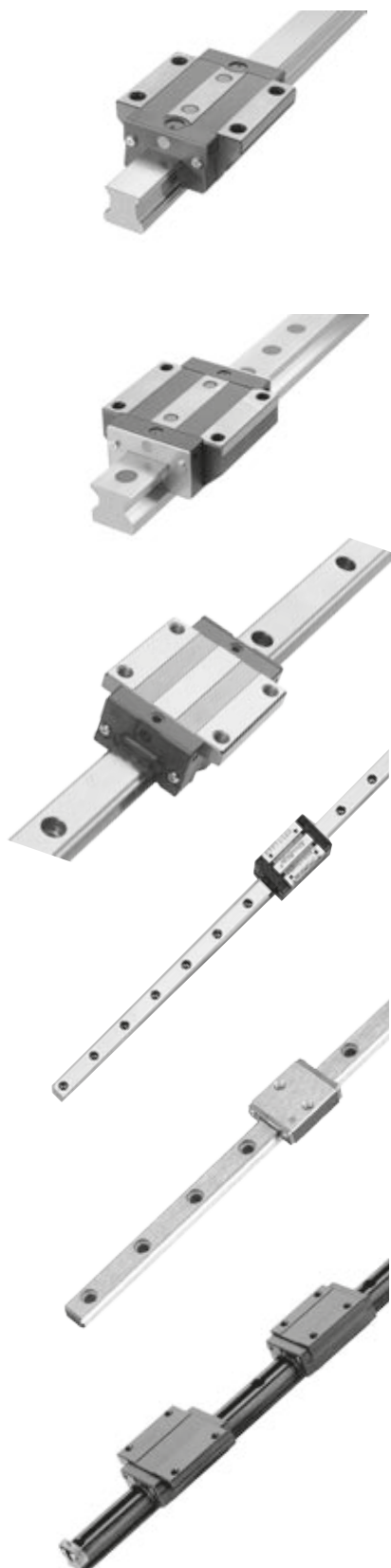

Table of Contents



**Overview of Thomson Profile Rail Linear Guides . . . . . 4**

**500 Series Ball Profile Rail Linear Guide . . . . . 8**  
**Thomson Next Generation Profile Rail. Superior Design. Superior Quality.**  
 Product overview . . . . . 9  
 Part numbering . . . . . 18  
 Datasheets . . . . . 22  
 Options and accessories . . . . . 32  
 Accuracy information . . . . . 43  
 Preload information . . . . . 43

**500 Series Roller Profile Rail Linear Guide . . . . . 45**  
**Thomson Next Generation Profile Rail. Superior Design. Superior Quality.**  
 Product overview . . . . . 45  
 Part numbering . . . . . 53  
 Datasheets . . . . . 56  
 Options and accessories . . . . . 60  
 Lubrication Fittings . . . . . 71  
 Accuracy information . . . . . 72  
 Preload information . . . . . 72

**400 Series Profile Rail Linear Guide . . . . . 74**  
**Transport Grade Ball Profile Rail System.**  
 Product overview . . . . . 74  
 Part numbering . . . . . 76  
 Datasheets . . . . . 78  
 Life calculations and tolerances . . . . . 86  
 Running smoothness . . . . . 87  
 Carriage dowel holes information . . . . . 89  
 Rail information . . . . . 91  
 Oil fittings . . . . . 92

**AccuMini . . . . . 93**  
**Ultra Compact, High Roll & Superior, Patented Ball Control Design.**  
 Product overview . . . . . 93  
 Part numbering . . . . . 93  
 Datasheets . . . . . 94  
 Accuracy information . . . . . 96  
 Preload information . . . . . 96

**MicroGuide . . . . . 97**

**T-Series . . . . . 105**

**Installation Guide . . . . . 112**

**Engineering Guide . . . . . 116**  
 Sizing, selection and life load calculations . . . . . 118  
 Deflection . . . . . 123  
 Lubrication . . . . . 146  
 Bellow cover calculations . . . . . 148  
 Butt joint specification sheets . . . . . 149  
 Conversion factors . . . . . 150

**Interchange Guide . . . . . 151**

500 Series Ball Profile Rail

500 Series Roller Profile Rail

400 Series Profile Rail

AccuMini

MicroGuide

T-Series

Installation Guide

Engineering Guide

Interchange Guide

## Overview of Thomson Profile Rail Linear Guides

Since the invention of the linear anti-friction Ball Bushing bearing by Thomson over 50 years ago, the Thomson precision linear products have meant high quality, innovative products. Today, Thomson continues producing and developing these high quality, innovative products. The Thomson Profile Rail assortment consists of the Next Generation Profile Rail “500 Series” Ball and Roller Linear Guides, compact miniature “MicroGuide™,” lightweight “T-Series,” and AccuMini.



The Thomson Profile Rail – Linear Guide Assortment is a complete assortment of rails and carriages in a broad range of styles, sizes and unique features produced to industry standard dimensions for easy retrofitting into existing applications or designing into new applications.

### 500 Series Ball Profile Rail Linear Guide

#### Features & Benefits

Superior Design. Superior Quality.

- Straight rails through advanced grinding technologies
- Simple installation and greater accuracy with joint-free rails up to 6 meters
- Smooth, quiet movement through patented insert molded recirculation paths and optimized geometries
- Extended lubrication life as a result of grease pockets built into the recirculation path
- Multiple carriage styles and sizes available
- On site field modifiable modular seals
- Rail and carriage options from stock or short delivery
- Customization with expanded accessory offering
- Replaces Thomson AccuGlide

### 500 Series Roller Profile Rail Linear Guide

#### Features & Benefits

Superior Design. Superior Quality.

- Industry leading load capacities
- High rigidity from back to back four roller track arrangement
- Straight rails through advanced grinding technologies
- Simple installation and greater accuracy with joint-free rails up to 6 meters
- Smooth, quiet movement through patented insert molded recirculation paths and optimized geometries
- Multiple carriage styles and sizes available
- On site field modifiable modular seals
- Rail and carriage options from stock or short delivery
- Customization with expanded accessory offering
- Replaces Thomson Accumax

#### Typical Applications

- Industrial Automation
- Industrial Robots
- Machine Tool Equipment
- Precision Measuring Equipment

#### Typical Applications

- Industrial Automation
- Machine Tool Equipment
- Precision Measuring Equipment
- Industrial Robots

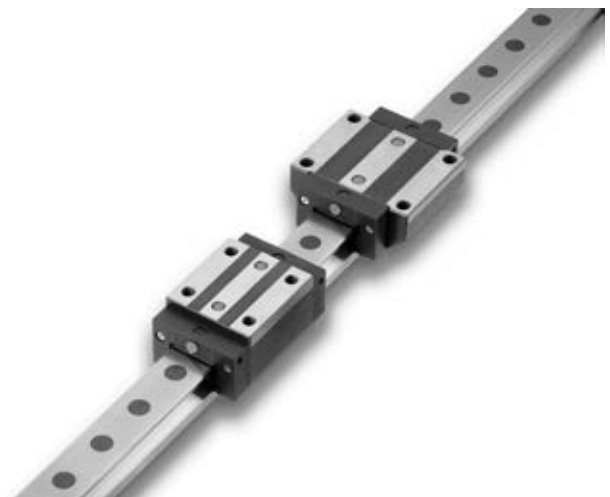

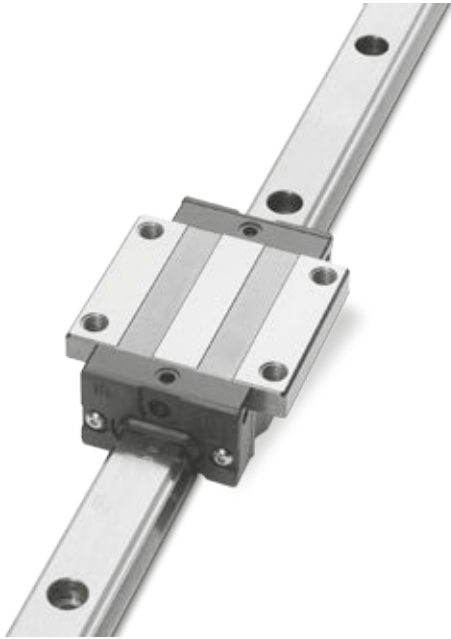

#### 400 Series Ball Profile Rail Linear Guide

##### Features & Benefits

- Polymer ball-return tube reduces noise and vibration while retaining lubrication
- Standard double lip end and longitudinal seals retain lubrication while protecting the bearing from contamination
- Lubrication channels that direct lubricant to individual ball tracks, maximizing lubricating effectiveness
- Double-faced ball tracks utilize a 45° face-to-face bearing arrangement, resulting in equal load-carrying capacity in all directions
- 413 ball cage option provides increased travel smoothness, lower noise at high speeds, and individual lubricant reservoirs
- See Thomson 400 Series Profile Rail Linear Guide catalog for more details

##### Typical Applications

- Industrial Automation
- Packaging Equipment
- Food Processing Equipment

#### AccuMini

##### Features & Benefits

- Ball control design for smooth, quiet, low friction at high speeds
- Full length integral wiper which protects important bearing from contaminants... effective system life is maximized
- Gothic design, which provides high roll moment capacity...a requirement for stand-alone applications
- Wear-resistant, engineered polymer retainer which reduces system inertia and noise

##### Typical Applications

- Wafer Handling Equipment
- Assembly Equipment
- Inspection and Measurement Equipment



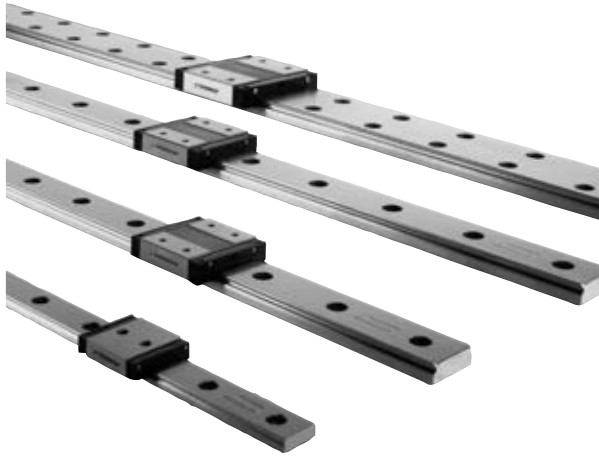

## MicroGuide

### Features & Benefits

- Industry standard drop-in replacement
- 440 stainless steel construction (corrosion resistance, little or no lubrication)
- High precision accuracy (up to  $\pm 0.010\text{mm}$ )
- Extremely smooth, quiet operation
- Low Profile
- High Moment Load Capacity for single rail / carriage applications
- Whisper quiet movement
- Gothic arch ball groove geometry provides enables single rail application
- One-piece length up to 1 meter (in sizes 7mm - 15mm)
- Contact Thomson for custom lengths and configurations

### Typical Applications

- Front end semiconductor processing equipment
- Backend semiconductor packaging and handling equipment
- Medical diagnostic and imaging equipment
- Laboratory automation equipment
- Testing and inspection equipment

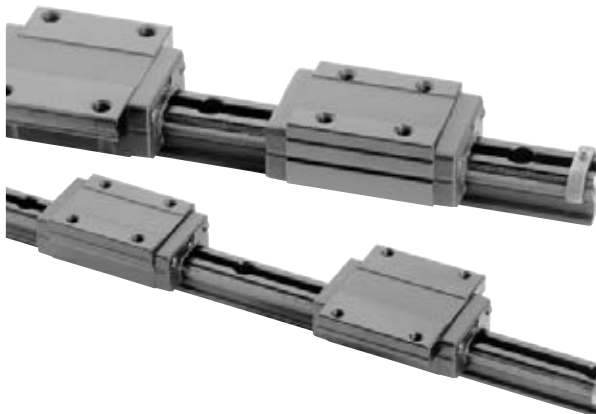

## T-Series

### Features & Benefits

- Lightweight, flexible and forgiving alternative to all-steel profile rail.
- High quality product made from aircraft aluminum alloy with hardened steel load bearing plates and ball paths.
- Ideal choice for applications requiring reduced weight or inertia.
- High flexibility translates into N class radial run out only.
- Proprietary "U" channel construction allows the rail to "flex" to accommodate poor machine bases or misalignment errors.
- Lower cost installation and reduced installation time by eliminating the need for a costly machined base and special tools.
- Drop-in replacement for conventional all-steel profile linear guides.

### Typical Applications

- Airplanes
- Automobiles
- Ships
- Packaging

### Assortment

Size [mm]	500 Series Ball							500 Series Roller				400 Series						AccuMini	MicroGuide		T-Series												
	Standard		Narrow					Standard		Narrow		Standard		Narrow				Standard	Standard	Wide	Standard												
	—	Long	—	Long	—	Long	Short	—	Long	—	Long	—	Long	—	—	—	—	—	—	—	—	—	—	—	—	—	—	—	—	—	—		
	—	—	—	—	High	High	—	—	—	—	—	—	—	—	—	—	—	—	—	—	—	—	—	—	—	—	—	—	—	—			
5																																	
7																																	
9																																	
10																																	
12																																	
15	•		•		•		•						•	•	•		•	•		•		•	•		•	•	•						
20	•	•	•	•			•						•	•	•	•				•		•	•		•					•	•	•	•
25	•	•	•	•	•	•		•	•	•	•		•	•	•	•	•	•		•		•	•		•				•	•	•	•	
30	•	•	•	•	•	•							•	•	•		•	•	•		•	•	•										
35	•	•	•	•	•	•		•	•	•	•		•	•	•		•	•	•		•	•	•					•	•	•	•		
45	•	•	•			•		•	•	•	•		•	•	•		•	•	•														
55								•	•	•	•		•	•	•		•	•	•														
65								•	•	•	•																						
Style	A	B	C	D	E	F	G	A	B	C	D	A	B	C	K	D	E	F	G	A	N/A	N/A	A	G	E	F							
Page	22	22	24	24	26	26	28	56	56	58	58	78	78	80	80	80	82	82	84	93	98	100	108	108	110	110							

### Application Criteria

Feature	500 Series Ball	500 Series Roller	400 Series	AccuMini	MicroGuide	T-Series
Load Capacity	•••	••••	•••	••	•	••
Equivalent Loads all directions	•••	••••	•••	••	••	•
Ultra Compactness	•	•	••	•••	••••	•
High Travel Accuracy	••••	••••	•••	••••	••••	•••
Rigidity	•••	••••	••	••	••	•
Smoothness	•••	••	•••	••••	••••	•••
Friction Characteristic	••••	••	•••	••••	••••	••
Admissible Speed	••••	•••	••••	••••	••••	•••
Ease of Installation	•••	••	•••	••	•••	••••
Lightweight	•	•	•	••	•••	••••
Industry Standard Dimensions	••••	••••	••••		••••	••••
Page	8	44	74	93	97	105

• = satisfactory    •••• = excellent

## 500 Series Ball Profile Rail Linear Guide

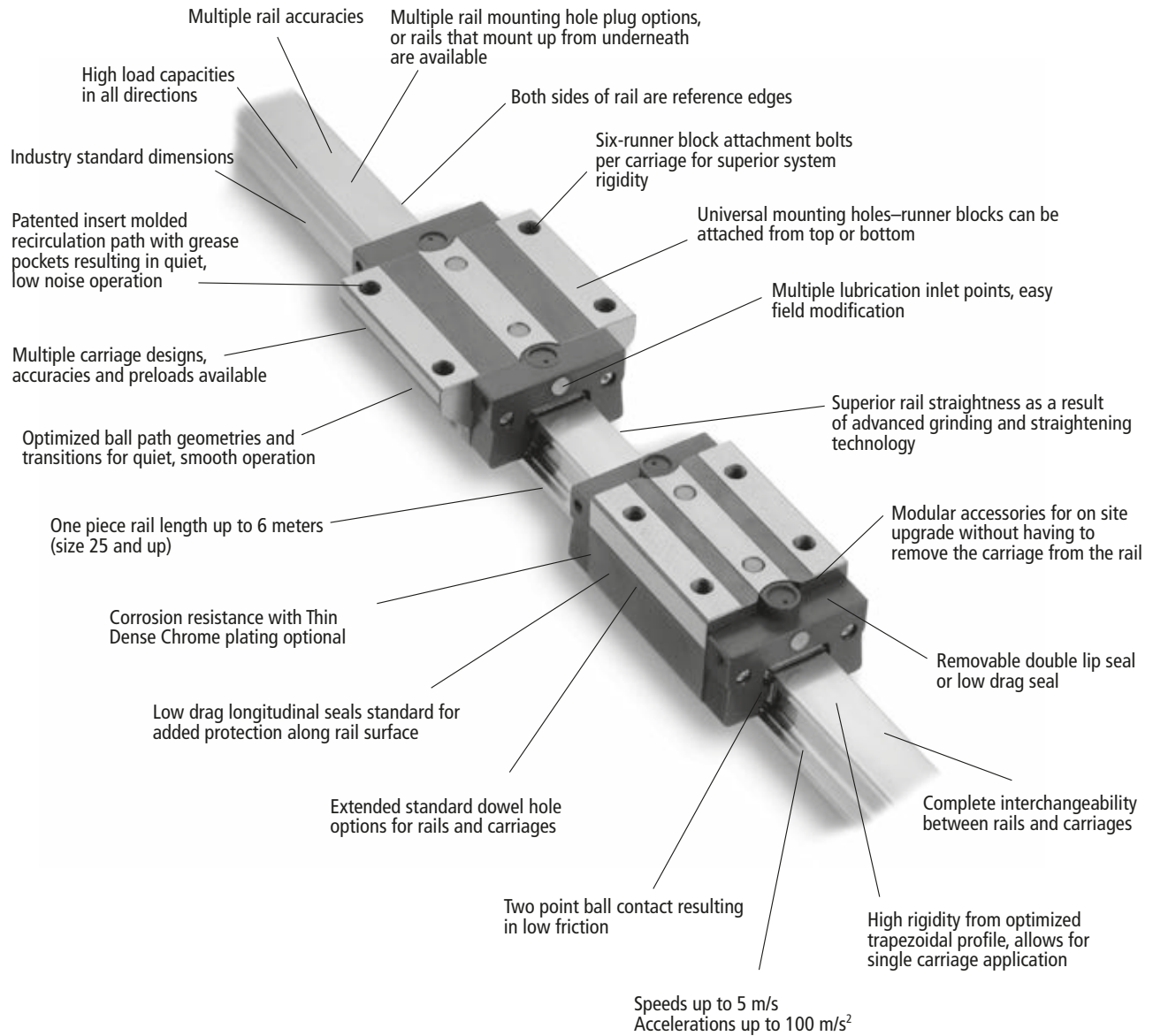



## 500 Series Ball Profile Rail Linear Guide



### Features

The Thomson 500 Series Ball Linear Guide provides long life, exceptional rigidity, high dynamic and static load capacities, accommodation for high moment loads, high running accuracy, multiple sealing options and multiple lubrication inlet options. This allows for on-site field modifications, and interchangeability with competitor offering.

These properties result in improved machine accuracies and rigidity resulting in reduced vibration extending machine and tool life. This has a direct effect on operational efficiency resulting in cost savings for the user.

Available in 7 carriage designs, and sizes 15 to 45mm.

### Materials Linear Guides

The 500 Series Ball Linear Guides are produced from high quality bearing steel. All carriages and rolling elements are through hardened and all rails are case hardened (except size 15 rail which is through hardened). The end cap is constructed of a high strength, glass filled nylon with nitrile rubber seal. Stringent quality controls are in place to ensure consistency of materials from the source, allowing us to ensure that we deliver the highest quality product.

### Interchangeability

The 500 Series Ball Linear Guides are completely interchangeable. Any carriage can be run on any rail of the same accuracy without compromising system accuracy. This is the result of our stringent manufacturing process controls.

### Accuracy and Preload

The 500 Series Ball Linear Guides are available in three different accuracy classes, three different preload ranges and with clearance to allow for customization to your application needs.

### Straightness

The 500 Series Ball rail is subjected to multiple straightening processes during and after grinding of the roller paths.

These added processes and inspections result in some of the straightest rails in the market today, improving machine accuracies wherever the 500 Series Ball is used.

### Rigidity

The 500 Series Ball Linear Guide rail utilizes a special trapezoidal profile that maximizes the carriage cross section, resulting in the highest possible rigidity.

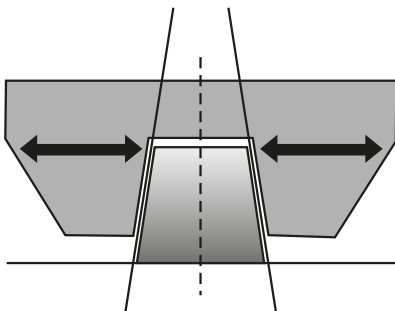

## 500 Series Ball Profile Rail Linear Guide

### Running Smoothness / Low Noise

The running smoothness and low noise are the result of a patented, custom insert molded recirculation path that has an optimized geometric shape and minimal transitions, to ensure smooth and quiet operation in both low and high-speed operation.

In addition, the balls make contact at only two points between rail and carriage. As a result, friction is reduced to a minimum, resulting in quiet, smooth operation.



### Back-to-Back

The 500 Series Linear Guide utilizes a back-to-back bearing arrangement, resulting in added rigidity. As a result, the 500 Series Ball can be used in single rail applications.

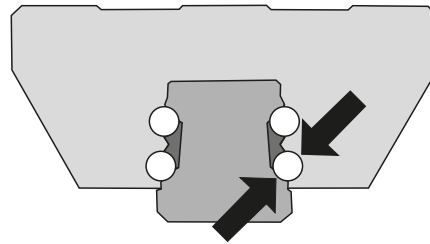

### Internal Grease Pockets

The patented insert molded recirculation path has built in grease pockets. These provide an extra level of security by ensuring adequate lubrication is available to the ball bearings to help extend life.

The pocket and area between the balls provide greater grease quantities in the ball path than a conventional designed linear guide bearing.

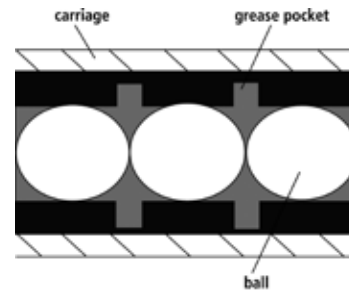

### Multiple Lubrication Options

The standard end cap is designed for flexibility. The end cap comes standard with four lubrication inlet options. These inlet options are easily changed on-site in the field or can be supplied from the factory.

Unsure of the best lubrication inlet location? These carriages allow the user to make these changes easily in the field to optimize the system performance. In addition, they allow for ease in maintenance – all without removing the carriage from the rail.



## 500 Series Ball Profile Rail Linear Guide



### Modular Accessory Options

The standard carriage is supplied with low friction double lip seals and longitudinal seals that completely encase the bearing carriage to protect the balls and track surfaces and minimize lubrication loss.

Optional metal scrapers or wipers, lube blocks and oil reservoir components can be easily added on-site in the field or can be supplied assembled from the factory.

The trapezoidal rail profile allows for easy servicing and replacing or adding of the end cap, additional wiper and oil reservoir without removing the carriage from the rail.

These innovative design features allow users to easily, efficiently, and economically upgrade carriage sealing.



### Longitudinal Seals

The carriage has built-in under carriage low drag longitudinal seals that protect the balls and ball path from contamination. These longitudinal seals are an added protection to increase the life and overall performance.

### Extended Standards

Extended Standards are an assortment of Thomson dowel hole options for both carriage and rail products. Take the guesswork out of design by using our standard assortment of dowel hole options for ease of design and availability, another solution from Thomson. Refer to page 28, 29 and 32 for more information and detailed datasheets.

### Rail Accessories

The rails have multiple options to protect the mounting holes to eliminate possible contamination entry into the bearing. Custom designed plastic plugs, mylar tape and stainless steel rail cover strip are available.



### Retained Balls

The rolling elements of the carriages are retained within the bearing so the carriage can be removed from the rail without worrying about the balls falling out. It is recommended to place any removed carriage onto an assembly rail or shipping arbor to provide added protection to the rolling elements.

## 500 Series Profile Rail Enhanced Carriage



### 66% Smoother Running Design, with 50% Lower Drag Force\* and Stainless Steel Options

#### Features and Benefits

Now available in all sizes: the Thomson 500 Series Profile Rail enhanced carriage design can improve the smoothness and precision of your linear motion application. Optional 440B stainless carriages and rails provide corrosion resistance well-suited for medical, food, electronic assembly and semiconductor applications.

- Smoother running design optimizes the surface interfaces between steel and plastic transition areas along the ball bearing circulation path.
- Standard end seals provide twice the contaminant protection compared to competitive products. Optional low drag end seals are ideal for low push force requirements.
- Four longitudinal seals per carriage provide much better contaminant protection than competitive designs with only two longitudinal seals.
- Additional lubrication reservoir enables longer running time and easy change end caps & seals are quick to replace.
- 100% interchangeable with previous Thomson 500 Series carriage and rail.

*\* 66% smoothness increase measured as variability of drag force while the carriage is in motion. 50% lower drag force measured with new low drag seals option; 41% lower drag force measured with standard wiper option.*

## 500 Series Ball Profile Rail Linear Guide

### Modular Accessory Exploded View

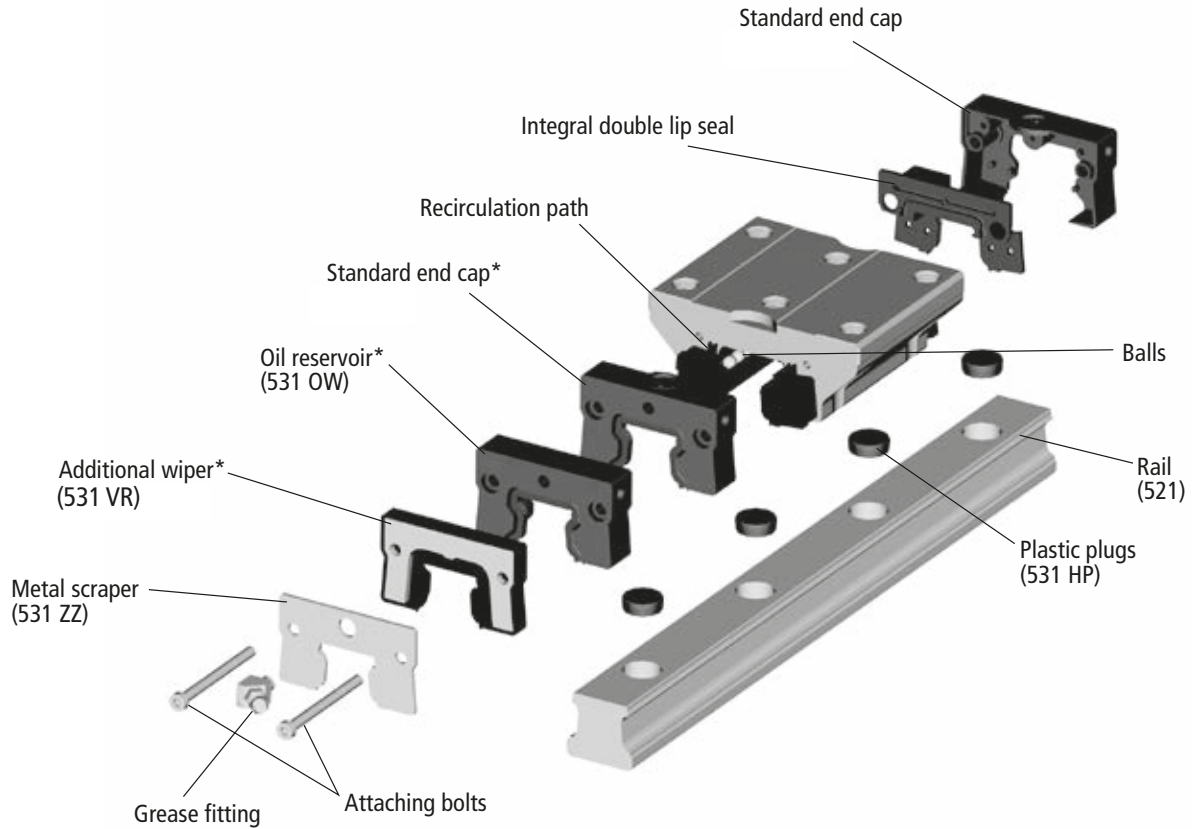

Also available (not shown):

- Lube Block (531 LL)
- Mylar Rail Tape (531 RT)
- Bolt up from bottom rail (521 Type U)
- Stainless Steel Rail, Cover Strip and Rail (521 Type C and 531RCS)

\* Can be installed without removing carriage from the rail

The modular building block design of the 500 Series Ball Profile Rail Linear Guide assembly allows for easy on-site field upgrades for quick seal or lubrication changes, all without the need to remove the carriage from the rail.

## 500 Series Ball Standard Carriages

Thomson offers six carriage styles with six mounting holes allowing for additional mounting configurations in the field or for retrofitting. All provide superior rigidity and design flexibility.

Style	Size	Accuracy	Basic Part Number				Appropriate Rail Standard Style	Max. Single Piece Rail Length (mm)	
			Clearance	Preload					
				0.03C	0.08C	0.13C			
Standard Carriage A	15	H	511H15A0	511H15A1	511H15A2	—	521H15A	1500	
		P	—	511P15A1	511P15A2	511P15A3	521P15A		
		U	—	511U15A1	511U15A2	511U15A3	521U15A		
	20	H	511H20A0	511H20A1	511H20A2	—	521H20A	3000	
		P	—	511P20A1	511P20A2	511P20A3	521P20A		
		U	—	511U20A1	511U20A2	511U20A3	521U20A		
	25	H	511H25A0	511H25A1	511H25A2	—	521H25A	6000	
		P	—	511P25A1	511P25A2	511P25A3	521P25A		
		U	—	511U25A1	511U25A2	511U25A3	521U25A		
	30	H	511H30A0	511H30A1	511H30A2	—	521H30A	6000	
		P	—	511P30A1	511P30A2	511P30A3	521P30A		
		U	—	511U30A1	511U30A2	511U30A3	521U30A		
	35	H	511H35A0	511H35A1	511H35A2	—	521H35A	6000	
		P	—	511P35A1	511P35A2	511P35A3	521P35A		
		U	—	511U35A1	511U35A2	511U35A3	521U35A		
	45	H	511H45A0	511H45A1	511H45A2	—	521H45A	6000	
		P	—	511P45A1	511P45A2	511P45A3	521P45A		
		U	—	511U45A1	511U45A2	511U45A3	521U45A		
Standard Long Carriage B	20	H	511H20B0	511H20B1	511H20B2	—	521H20A	3000	
		P	—	511P20B1	511P20B2	511P20B3	521P20A		
		U	—	511U20B1	511U20B2	511U20B3	521U20A		
	25	H	511H25B0	511H25B1	511H25B2	—	521H25A	6000	
		P	—	511P25B1	511P25B2	511P25B3	521P25A		
		U	—	511U25B1	511U25B2	511U25B3	521U25A		
	30	H	511H30B0	511H30B1	511H30B2	—	521H30A	6000	
		P	—	511P30B1	511P30B2	511P30B3	521P30A		
		U	—	511U30B1	511U30B2	511U30B3	521U30A		
	35	H	511H35B0	511H35B1	511H35B2	—	521H35A	6000	
		P	—	511P35B1	511P35B2	511P35B3	521P35A		
		U	—	511U35B1	511U35B2	511U35B3	521U35A		
	45	H	511H45B0	511H45B1	511H45B2	—	521H45A	6000	
		P	—	511P45B1	511P45B2	511P45B3	521P45A		
		U	—	511U45B1	511U45B2	511U45B3	521U45A		
	Narrow Carriage C	15	H	511H15C0	511H15C1	511H15C2	—	521H15A	1500
			P	—	511P15C1	511P15C2	511P15C3	521P15A	
			U	—	511U15C1	511U15C2	511U15C3	521U15A	
20		H	511H20C0	511H20C1	511H20C2	—	521H20A	3000	
		P	—	511P20C1	511P20C2	511P20C3	521P20A		
		U	—	511U20C1	511U20C2	511U20C3	521U20A		
25		H	511H25C0	511H25C1	511H25C2	—	521H25A	6000	
		P	—	511P25C1	511P25C2	511P25C3	521P25A		
		U	—	511U25C1	511U25C2	511U25C3	521U25A		
30		H	511H30C0	511H30C1	511H30C2	—	521H30A	6000	
		P	—	511P30C1	511P30C2	511P30C3	521P30A		
		U	—	511U30C1	511U30C2	511U30C3	521U30A		
35		H	511H35C0	511H35C1	511H35C2	—	521H35A	6000	
		P	—	511P35C1	511P35C2	511P35C3	521P35A		
		U	—	511U35C1	511U35C2	511U35C3	521U35A		
Narrow Long Carriage D		20	H	511H20D0	511H20D1	511H20D2	—	521H20A	3000
			P	—	511P20D1	511P20D2	511P20D3	521P20A	
			U	—	511U20D1	511U20D2	511U20D3	521U20A	
	25	H	511H25D0	511H25D1	511H25D2	—	521H25A	6000	
		P	—	511P25D1	511P25D2	511P25D3	521P25A		
		U	—	511U25D1	511U25D2	511U25D3	521U25A		
	30	H	511H30D0	511H30D1	511H30D2	—	521H30A	6000	
		P	—	511P30D1	511P30D2	511P30D3	521P30A		
		U	—	511U30D1	511U30D2	511U30D3	521U30A		
	35	H	511H35D0	511H35D1	511H35D2	—	521H35A	6000	
		P	—	511P35D1	511P35D2	511P35D3	521P35A		
		U	—	511U35D1	511U35D2	511U35D3	521U35A		

Style	Size	Accuracy	Basic Part Number				Appropriate Rail Standard Style	Max. Single Piece Rail Length (mm)	
			Clearance	Preload					
				0.03C	0.08C	0.13C			
Narrow High Carriage E	15	H	511H15E0	511H15E1	511H15E2	—	521H15A	1500	
		P	—	511P15E1	511P15E2	511P15E3	521P15A		
		U	—	511U15E1	511U15E2	511U15E3	521U15A		
	25	H	511H25E0	511H25E1	511H25E2	—	521H25A	6000	
		P	—	511P25E1	511P25E2	511P25E3	521P25A		
		U	—	511U25E1	511U25E2	511U25E3	521U25A		
	30	H	511H30E0	511H30E1	511H30E2	—	521H30A	6000	
		P	—	511P30E1	511P30E2	511P30E3	521P30A		
		U	—	511U30E1	511U30E2	511U30E3	521U30A		
	35	H	511H35E0	511H35E1	511H35E2	—	521H35A	6000	
		P	—	511P35E1	511P35E2	511P35E3	521P35A		
		U	—	511U35E1	511U35E2	511U35E3	521U35A		
	45	H	511H45E0	511H45E1	511H45E2	—	521H45A	6000	
		P	—	511P45E1	511P45E2	511P45E3	521P45A		
		U	—	511U45E1	511U45E2	511U45E3	521U45A		
	Narrow High Long Carriage F	25	H	511H25F0	511H25F1	511H25F2	—	521H25A	6000
			P	—	511P25F1	511P25F2	511P20F3	521P25A	
			U	—	511U25F1	511U25F2	511U20F3	521U25A	
30		H	511H30F0	511H23F1	511H30F2	—	521H30A	6000	
		P	—	511P30F1	511P30F2	511P30F3	521P30A		
		U	—	511U30F1	511U30F2	511U30F3	521U30A		
35		H	511H35F0	511H35F1	511H35F2	—	521H35A	6000	
		P	—	511P35F1	511P35F2	511P35F3	521P35A		
		U	—	511U35F1	511U35F2	511U35F3	521U35A		
45		H	511H45F0	511H45F1	511H45F2	—	521H45A	6000	
		P	—	511P45F1	511P45F2	511P45F3	521P45A		
		U	—	511U45F1	511U45F2	511U45F3	521U45A		
Narrow Short Carriage G	15	H	511H15G0	511H15G1	511H15G2	—	521H15A	1500	
		P	—	511P15G1	511P15G2	511P15G3	521P15A		
		U	—	511U15G1	511U15G2	511U15G3	521U15A		
	20	H	511H20G0	511H20G1	511H20G2	—	521H20A	3000	
		P	—	511P20G1	511P20G2	511P20G3	521P20A		
		U	—	511U20G1	511U20G2	511U20G3	521U20A		

**Extended Standard Carriage Options**

The carriages are also available with the Thomson standard dowel holes or lubrication inlets as shown on pages 28 to 32 or special lubricants either from stock or with a short lead-time.

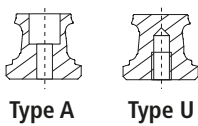

**Rail Types and Accessories**

The rails are available in two configurations:

- Bolt down from the top – 521 Type A
- Bolt up from the bottom – 521 Type U

The standard 521 rail mounting holes can be plugged or sealed after installation with the options below.

**Plastic Plugs**

531HP plastic plugs are an inexpensive and simple method to seal the rail attachment bolt area. The plastic plugs are easily driven in place to any rail with a soft non-metallic drift. They can easily be removed.

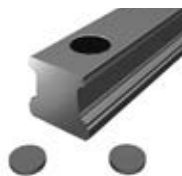

**Mylar Tape**

A simple and low cost alternative is specialty Mylar tape that can be placed quickly on the top surface of the rail. Part number 531RT is available in 3 meter lengths.

**Stainless Steel Cover Strip**

Option 531RCS utilizes a special rail (521 Type C) and stainless steel cover strip that is easily installed with the proper mounting tool.



## Additional Seal Types and Lubrication Accessories



The carriage is designed with modular sealing and lubrication options for simple on-site field modification or can be supplied factory direct.



The standard carriage end cap has an integral low friction double lip seal and longitudinal seal that completely encase the bearing carriage. The double lip design keeps contaminants out and lubrication in. It also allows for grease to purge out of the carriage to prevent excessive lubrication, which can result in higher operating temperatures. This double lip design can be used with oil lubrication.

The standard carriage end cap is equipped with a lubrication inlet centered with a specially designed lubricant channel to direct the lubrication to individual ball tracks. The lubrication inlet can be easily changed in the field or supplied from the factory with a side inlet or top inlet.

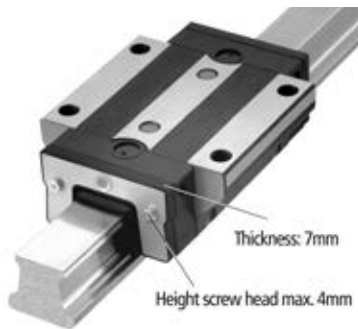

### Additional Seal

The **531 VR** seal provide an additional level of protection from contaminants to the assembly. This additional component can easily be added on-site without removing the carriage from the rail. It is supplied with the required screws to make the installation simple.

- 531 VR is constructed from durable Viton®

This seal can be used in conjunction with other optional modular accessories providing an easy upgrade to the standard seal. It can be easily installed on-site in the field or can be supplied from the factory.



### Metal Scraper

The Type **531 ZZ Metal Scraper** made of stainless steel, serves as an added protection to the seal lips against large dirt particles, metal shavings or chips. Large contaminants are easily pushed away providing an extra level of protection to the seal lips. The Metal Scraper is easily installed in conjunction with the other optional modular accessories providing you with an easy upgrade to the standard seal. These can be easily installed on-site in the field or can be supplied from the factory.





**Oil Reservoir**

The Type **531 OW oil reservoir** is a cost effective, automatic lubrication system. It is constructed with an integrated oil reservoir that provides a uniform, consistent lubricating oil to the ball paths for extended periods of time. The Type 531 OW oil reservoir lubrication plate eliminates the need for a routine maintenance schedule, assures lubrication gets to the required points, can be refilled if required, and can operate up to 5000 km of travel. The Type 531 OW oil reservoir can be easily installed in conjunction with other optional modular accessories providing an easy upgrade to the standard seals. These can be easily installed on-site in the field or can be supplied from the factory.

**Lube Block**

The **531 LL Lube Block** is a solid lubricant that is a mixture of polymers, oils and selected additives that reduce the penetration of dirt, grit, and liquids into the ball path, preventing premature failures. The oil diffuses, lubricating the ball path surfaces by capillary action. Additional oil is supplied to the ball path surfaces from the polymer. For additional protection the assembly is packed with EP2 grease. There is no need for maintenance or additional lubrication during the life of the Lube Block filled bearing. The 531 LL Lube Block can be easily installed in conjunction with the other optional modular accessories providing an easy upgrade to the standard seal. These can be easily installed on-site in the field or can be supplied from the factory.

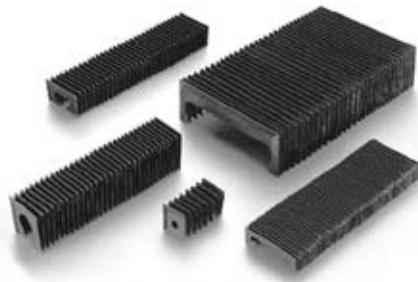

**Bellows**

**Standard bellows** are available for all assemblies. The bellows cover the entire length of the rail. The bellows are used to provide additional protection against dirt, dust and splashed liquids. Installation is simple and requires little time. Retrofitting is possible when the rail ends are drilled for the attachment of the end plate 531. Bellows are available in three styles:

- Type B “Low Profile” with outside dimensions that do not exceed the carriage
- Type C “High Compression”
- Type W “Walk On” capable of handling the harshest environments with a 90 kg load bearing capacity

The bellow can be easily installed in conjunction with other optional modular seals providing you with a simple upgrade to the standard seal. These can be installed on-site in the field or can be supplied from the factory.

Note: Additional modular accessories add additional drag to the carriage assembly resulting in increased start up friction and power consumption.

Relative Drag Comparison for Design Consideration

Type	Relative Drag
Standard carriage	•
Viton® Wiper (531 VR)	•••
Metal Scraper (531 ZZ)	•
Oil Reservoir (531 OW)	••
Lube Block (531 LL)	••••

• Low

**For ordering information or for additional Seal Types and Lubrication Accessories, see pages 38 to 39.**

## 500 Series Ball

### Part Numbering Description

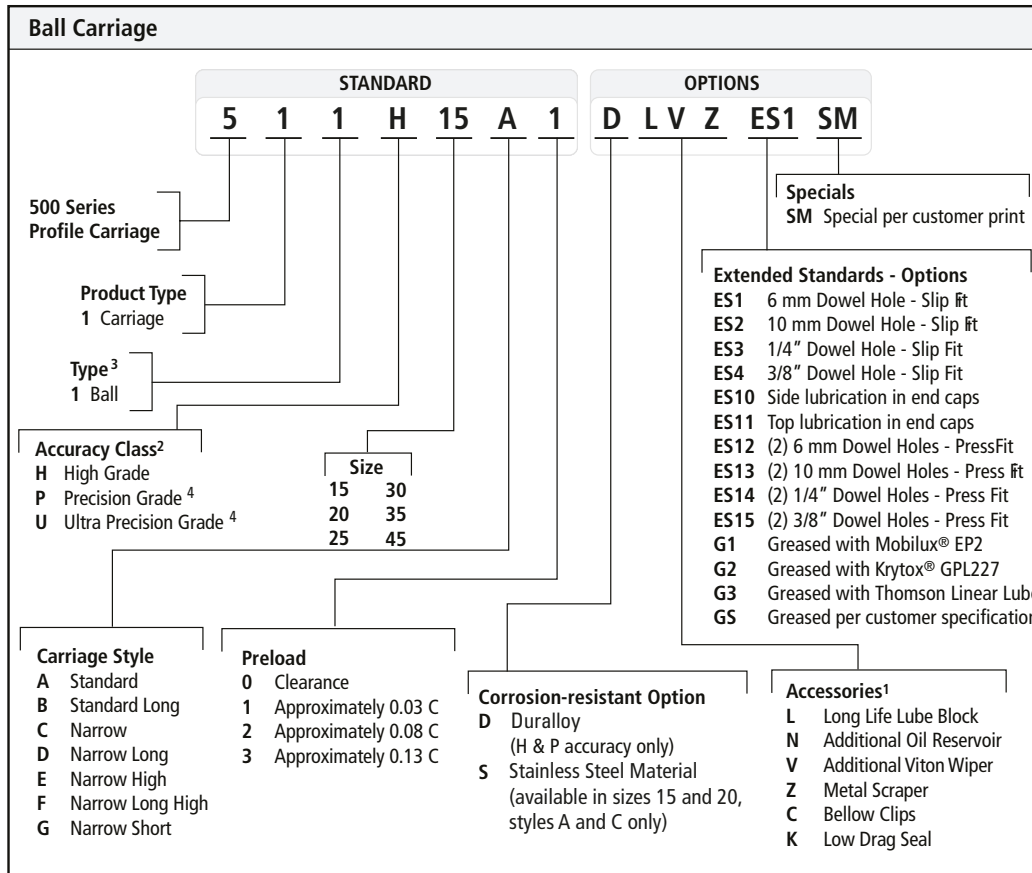

1. Accessory combination part numbers are listed from carriage end cap outward. Not all combinations are available. For specific combination availability see pages 34-35.

2. The 500 Series Ball lowest accuracy grade is High as a result of tight manufacturing controls and grinding capabilities. We do not offer Normal grade accuracy, our High grade is our Normal grade.

3. New enhanced carriage does not retain ball bearings when end cap is removed. Removal of end caps can result in loss of ball bearings.

4. Available with preload only.

# 500 Series Ball

## Part Numbering Description

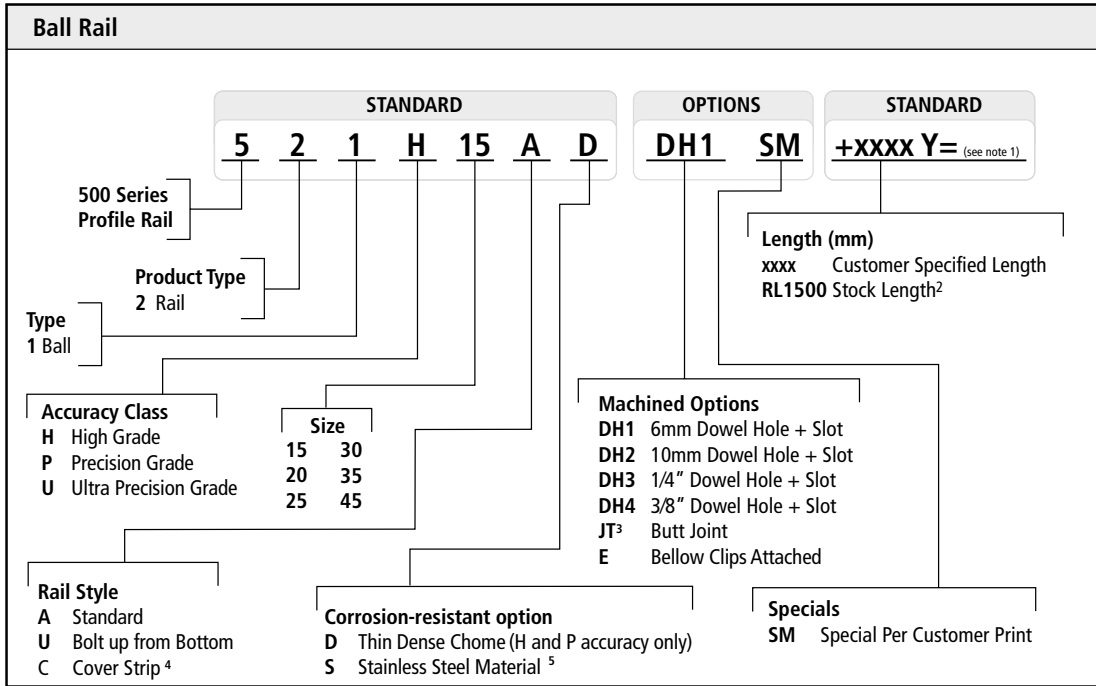

1. Y = Distance from end of rail to center of first mounting hole, Y1 = Y2 unless specified
2. Stock length rails are considered random length, total length may exceed specified length, and Y1/Y2 are not equal. To be used by customer who will cut to length.
3. Customer drawing required at time of quote and order. See page 119 for more information and templates.
4. Cover strip rail available in size 25 and up only.
5. Available in sizes 15 and 20 only. Max. rail length at 1,000 mm.

## 500 Series Part Numbering Description

### Part Numbering Description

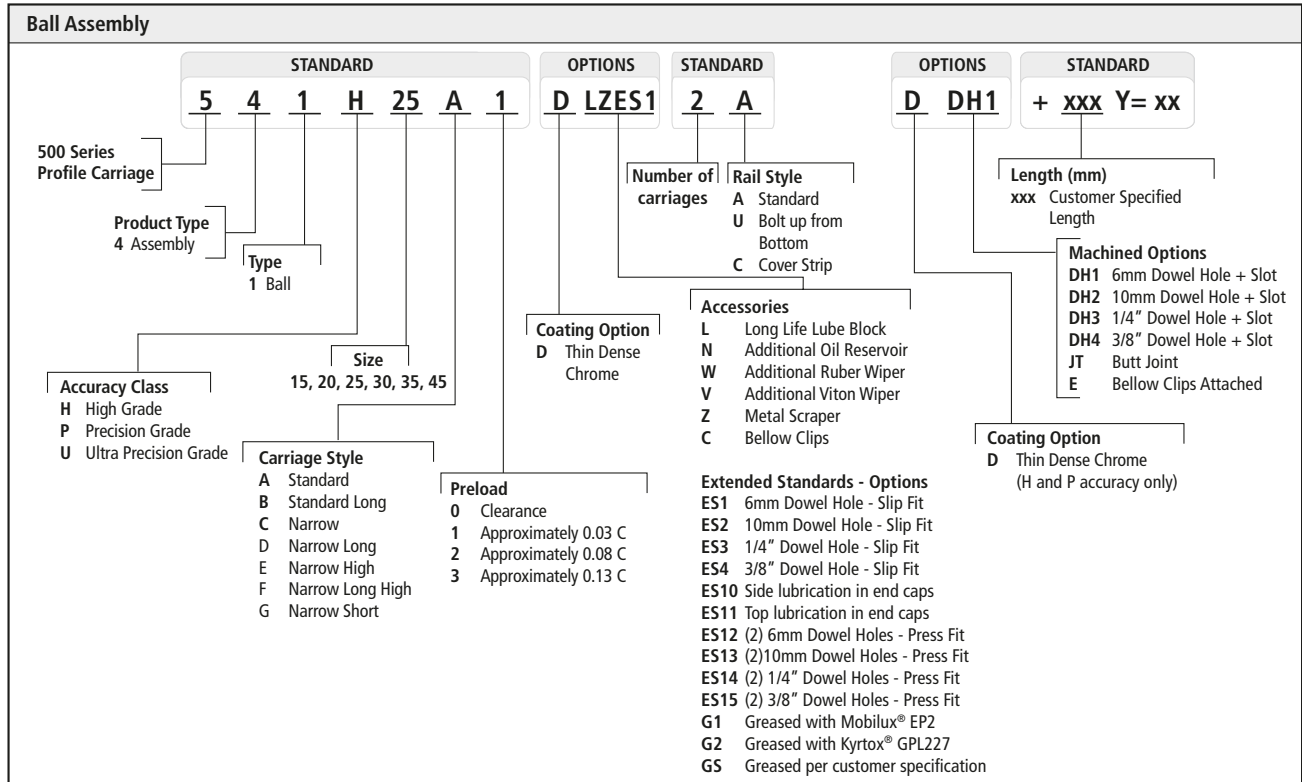

# 500 Series Part Numbering Description

## Part Numbering Description

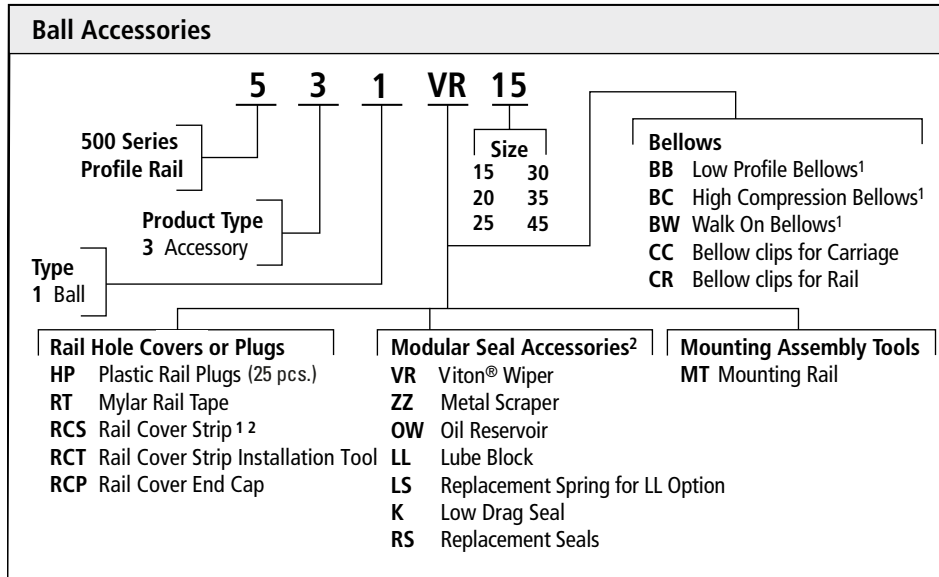

1. Bellows and rail cover strip must include length at time of order.  
Example: 531BB15 + 1000mm. See page 115 on how to calculate bellows length.

2. Cover strip rail available in size 25 and up only.

3. Two standard screws included with each item. Screws for attaching this accessory to carriage and not combinations of accessories.

## 500 Series Ball

### 511 Style A and B

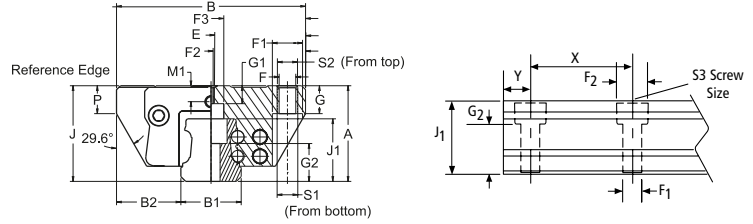

**511 Style A**

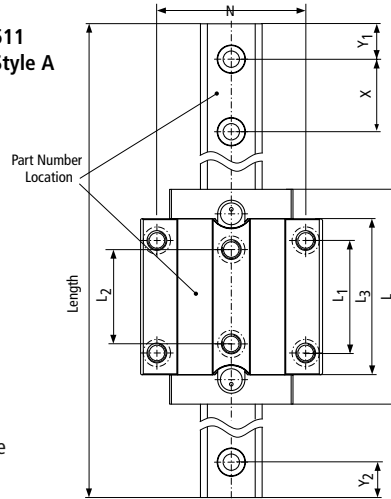

**511 Style B**

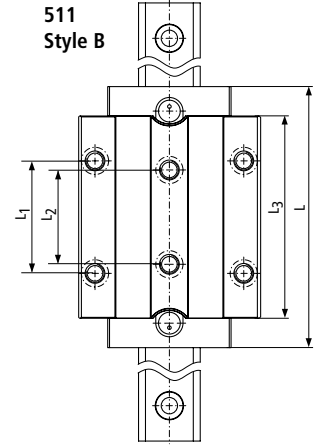

Stainless Steel Material  
(available in sizes 15, 20,  
25 and 35 and carriage style  
styles A and C only)

### 511 Style A – Standard Ball

Size	Dimensions (mm)						L	L <sub>1</sub>	L <sub>2</sub>	L <sub>3</sub>	X	N	S <sub>1</sub>	S <sub>2</sub>	S <sub>3</sub>	F	F <sub>1</sub>	F <sub>2</sub>	F <sub>3</sub>	Ball						
	A	B	B <sub>1</sub> *	B <sub>2</sub>	J	J <sub>1</sub>														Ø	G	G <sub>1</sub>	G <sub>2</sub>	M <sub>1</sub>	O	P
15	24	47	15	16	20.2	15.7	56.6	30	26	39.6	60	38	M 4	M 5	M 4	4.4	4.5	8	7.5	3.2	7	4.5	9.5	4	7	7
20	30	63	20	21.5	25.5	19	71.5	40	35	49.5	60	53	M 5	M 6	M 5	5.4	5.8	10	9.5	4.0	8	6.5	11.5	5.2	8	8
25	36	70	23	23.5	30.5	22.7	84.5	45	40	59.5	60	57	M 6	M 8	M 6	6.8	7	11	11	4.8	9	8.7	14	5.5	7	11
30	42	90	28	31	35.9	26	97.4	52	44	69.4	80	72	M 8	M 10	M 8	8.5	9	15	15	5.6	12	10	14.5	7	8	12
35	48	100	34	33	41	29.5	111.6	62	52	79.6	80	82	M 8	M 10	M 8	8.5	9	15	15	6.4	12	12	18	7	8	14
45	60	120	45	37.5	50.8	37	137.1	80	60	99.1	105	100	M 10	M 12	M 12	10.5	14	20	18	7.9	15	15	22	8	10	17.5

### 511 Style B – Standard Long Ball

Size	Dimensions (mm)						L	L <sub>1</sub>	L <sub>2</sub>	L <sub>3</sub>	X	N	S <sub>1</sub>	S <sub>2</sub>	S <sub>3</sub>	F	F <sub>1</sub>	F <sub>2</sub>	F <sub>3</sub>	Ball						
	A	B	B <sub>1</sub> *	B <sub>2</sub>	J	J <sub>1</sub>														Ø	G	G <sub>1</sub>	G <sub>2</sub>	M <sub>1</sub>	O	P
20	30	63	20	21.5	25.5	19	87.5	40	35	65.5	60	53	M 5	M 6	M 5	5.4	5.8	10	9.5	4.0	8	6.5	11.5	5.2	8	8
25	36	70	23	23.5	30.5	22.7	103.5	45	40	78.5	60	57	M 6	M 8	M 6	6.8	7	11	11	4.8	9	8	14	5.5	7	11
30	42	90	28	31	35.9	26	119.4	52	44	91.4	80	72	M 8	M 10	M 8	8.5	9	15	15	5.6	12	10	14.5	7	8	12
35	48	100	34	33	41	29.5	137.1	62	52	105.1	80	82	M 8	M 10	M 8	8.5	9	15	15	6.4	12	12	18	7	8	14
45	60	120	45	37.5	50.8	37	168.6	80	60	130.6	105	100	M 10	M 12	M 12	10.5	14	20	18	7.9	15	15	22	8	10	17.5

\* Standard tolerance shown, special lower tolerances are available upon request. Please consult application engineering for additional information.  
† All thread pitches will be ISO coarse.

# 500 Series Ball

## 511 Style A and B

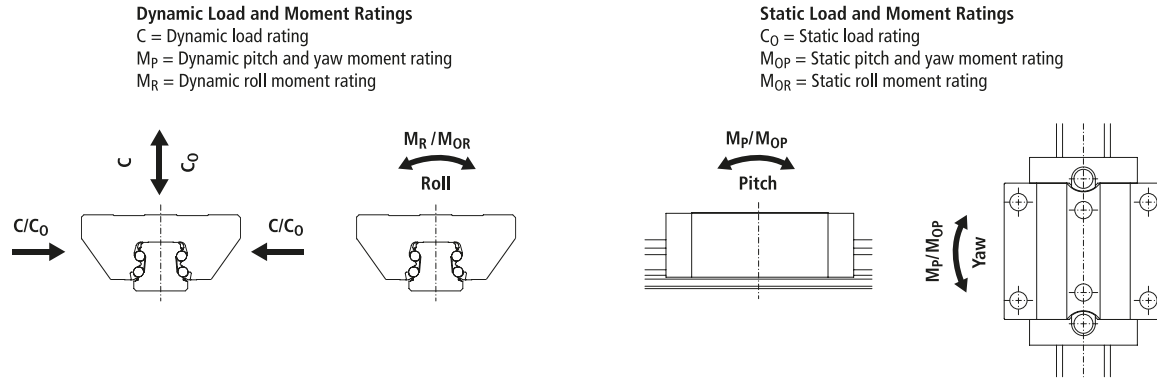

511 Style	Size	Load Rating									Weights	
		Static			Dynamic						Carriage (kg)	Rail (kg/m)
		C <sub>0</sub> (N)	M <sub>OR</sub> (Nm)	M <sub>OP, OY</sub> (Nm)	100 Km			50 Km				
C (N)	M <sub>R</sub> (Nm)	M <sub>P, Y</sub> (Nm)	C (N)	M <sub>R</sub> (Nm)	M <sub>P, Y</sub> (Nm)	C (N)	M <sub>R</sub> (Nm)	M <sub>P, Y</sub> (Nm)				
A	15	19 600	181	146	9 000	83	67	11 339	105	84	0.2	1.4
	15-S	19 600	181	146	7 600	70	57	9 576	88	72	0.2	1.4
	20	31 400	373	292	14 400	171	134	18 143	215	169	0.5	2.2
	20-S	31 400	373	292	12 000	143	112	15 120	180	141	0.5	2.2
	25	46 100	631	513	21 100	289	235	26 584	364	296	0.7	3.0
	30	63 700	1 084	829	29 200	497	380	36 790	626	479	1.2	4.3
	35	84 400	1 566	1 252	38 700	718	574	48 759	905	723	1.8	5.4
	45	134 800	3 193	2 498	61 900	1466	1 147	77 989	1 847	1 445	3.3	8.8
B	20	41 100	490	495	17 400	206	208	21 923	260	262	0.6	2.2
	25	60 300	825	863	25 500	349	365	32 128	440	460	0.9	3.0
	30	83 300	1 414	1 390	35 300	599	589	44 475	755	742	1.5	4.3
	35	110 300	2 048	2 104	46 700	867	891	58 838	1 092	1 123	2.3	5.4
	45	176 300	4 175	4 199	74 700	1 769	1 779	94 116	2 229	2 241	4.2	8.8

1. The dynamic load and moment ratings are based on the travel life specified on the table (100 km or 50 km). When comparing these load ratings with other bearings you must take into consideration the proper travel life basis.

2. The static load and moment ratings are the maximum radial load and moment load that should be applied to the bearing when there is no relative motion between the carriage and the rail.

### Bearing Travel Life Comparison

$L = (C/F)^3 \times 100\text{km}$   
 where:  
 L = travel life, km  
 C = 100 km dynamic load rating  
 F = applied dynamic load, N

$C_{min} = F \left( \frac{L}{100} \right)^{1/3}$   
 where:  
 C<sub>min</sub> = minimum required dynamic load rating, N  
 F = applied dynamic load, N  
 L = required travel life, km

**Operating Parameters:**  
**Maximum Velocity:** 5 m/s  
**Maximum Acceleration:** 100 m/s<sup>2</sup>  
**Temperature:**  
 Min: -40° C  
 Max: 80° C  
 Max peak: 120° C short time\*  
 \*without bellows

Conversion Factors: See Page 125

## 500 Series Ball Profile Rail Linear Guide

### 511 Style C and D

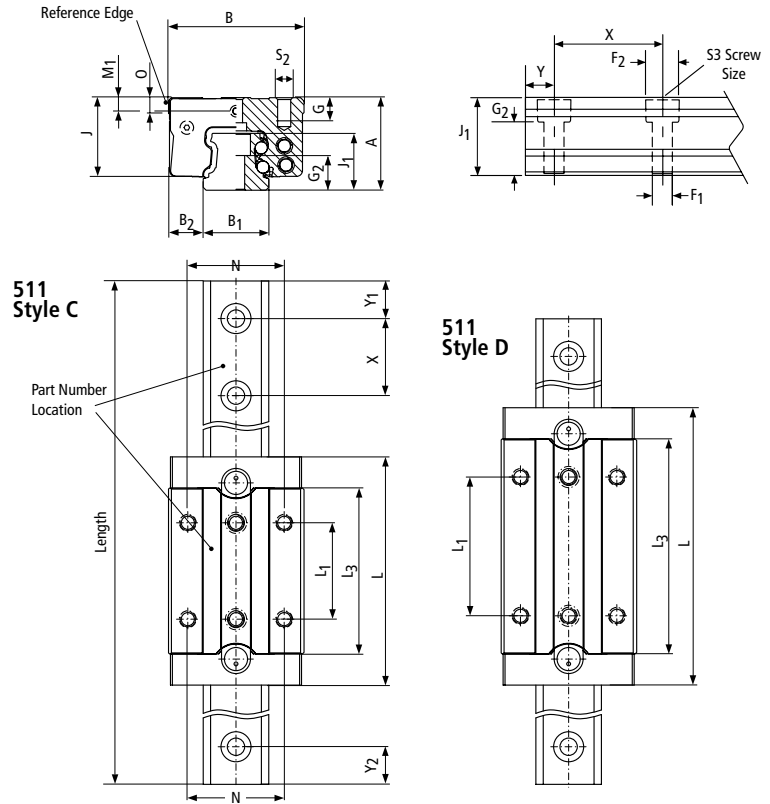
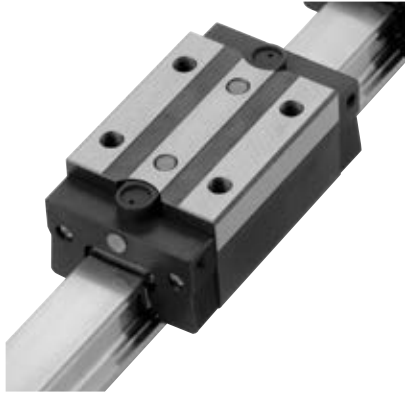

### 511 Style C Narrow

Size	Dimensions (mm)			B <sub>2</sub>	J	J <sub>1</sub>	L	L <sub>1</sub>	L <sub>3</sub>	X	N	S <sub>2</sub> /S <sub>3</sub>	F <sub>1</sub>	F <sub>2</sub>	Ball Ø	G	G <sub>2</sub>	M <sub>1</sub>	O
	A	B	B <sub>1</sub> *																
15	24	34	15	9.5	20.2	15.7	56.6	26	39.6	60	26	M 4	4.5	8	3.2	5	9.5	4	5.5
20	30	44	20	12	25.5	19	71.5	36	49.5	60	32	M 5	5.8	10	4.0	7	11.5	5.2	6
25	36	48	23	12.5	30.5	22.7	84.5	35	59.5	60	35	M 6	7	11	4.8	9	14	5.5	7.5
30	42	60	28	16	35.9	26	97.4	40	69.4	80	40	M 8	9	15	5.6	11	14.5	7	8
35	48	70	34	18	41	29.5	111.6	50	79.6	80	50	M 8	9	15	6.4	12	18	7	8

### 511 Style D Narrow Long

Size	Dimensions (mm)			B <sub>2</sub>	J	J <sub>1</sub>	L	L <sub>1</sub>	L <sub>3</sub>	X	N	S <sub>2</sub> /S <sub>3</sub>	F <sub>1</sub>	F <sub>2</sub>	Ball Ø	G	G <sub>2</sub>	M <sub>1</sub>	O
	A	B	B <sub>1</sub> *																
20	30	44	20	12	25.5	19	87.5	50	65.5	60	32	M 5	5.8	10	4.0	7	11.5	5.2	6
25	36	48	23	12.5	30.5	22.7	103.5	50	78.5	60	35	M 6	7	11	4.8	9	14	5.5	7.5
30	42	60	28	16	35.9	26	119.4	60	91.4	80	40	M 8	9	15	5.6	11	14.5	7	8
35	48	70	34	18	41	29.5	137.1	72	105.1	80	50	M 8	9	15	6.4	12	18	7	8

\* Standard tolerance shown, special lower tolerances are available upon request. Please consult application engineering for additional information.



# 500 Series Ball

## 511 Style C and D

### Dynamic Load and Moment Ratings

C = Dynamic load rating  
M<sub>P</sub> = Dynamic pitch and yaw moment rating  
M<sub>R</sub> = Dynamic roll moment rating

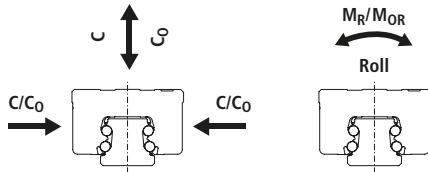

### Static Load and Moment Ratings

C<sub>0</sub> = Static load rating  
M<sub>OP</sub> = Static pitch and yaw moment rating  
M<sub>OR</sub> = Static roll moment rating

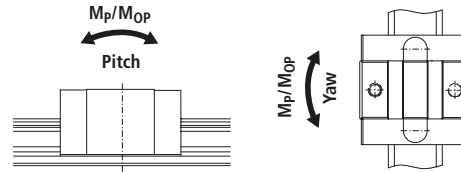

511 Style	Size	Load Rating									Weights	
		Static			Dynamic						Carriage (kg)	Rail (kg/m)
		C <sub>0</sub> (N)	M <sub>OR</sub> (Nm)	M <sub>OP, OY</sub> (Nm)	100 Km			50 Km				
C (N)	M <sub>R</sub> (Nm)	M <sub>P, Y</sub> (Nm)	C (N)	M <sub>R</sub> (Nm)	M <sub>P, Y</sub> (Nm)	C (N)	M <sub>R</sub> (Nm)	M <sub>P, Y</sub> (Nm)				
C	15	19 600	181	146	9 000	83	67	11 339	105	84	0.2	1.4
	15-S	19 600	181	146	7 600	70	57	9 576	88	106	0.2	1.4
	20	31 400	373	292	14 400	171	134	18 143	215	169	0.5	2.2
	20-S	31 400	373	292	12 000	143	112	15 120	180	141	0.5	2.2
	25	46 100	631	513	21 100	289	235	26 584	364	296	0.7	3.0
	30	63 700	1 084	829	29 200	497	380	36 790	626	479	1.2	4.3
D	35	84 400	1 566	1 252	38 700	718	574	48 759	905	723	1.8	5.4
	20	41 100	490	495	17 400	206	208	21 923	260	262	0.6	2.2
	25	60 300	825	863	25 500	349	365	32 128	440	460	0.9	3.0
	30	83 300	1 414	1 390	35 300	599	589	44 475	755	742	1.5	4.3
	35	110 300	2 048	2 104	46 700	867	891	58 838	1 092	1 123	2.3	5.4

1. The dynamic load and moment ratings are based on the travel life specified on the table (100 km or 50 km). When comparing these load ratings with other bearings you must take into consideration the proper travel life basis.

2. The static load and moment ratings are the maximum radial load and moment load that should be applied to the bearing when there is no relative motion between the carriage and the rail.

### Bearing Travel Life Comparison

$$L = (C/F)^3 \times 100 \text{ km}$$

where:

L = travel life, km

C = 100 km dynamic load rating

F = applied dynamic load, N

$$C_{\min} = F \left( \frac{L}{100} \right)^{1/3}$$

where:

C<sub>min</sub> = minimum required dynamic load rating, N

F = applied dynamic load, N

L = required travel life, km

### Operating Parameters:

Maximum Velocity: 5 m/s

Maximum Acceleration: 100 m/s<sup>2</sup>

Temperature: Min: -40° C

Max: 80° C

Max peak: 120° C short time\*

\*without bellows

Conversion Factors: See Page 150

## 500 Series Ball Profile Rail Linear Guide

### 511 Style E and F

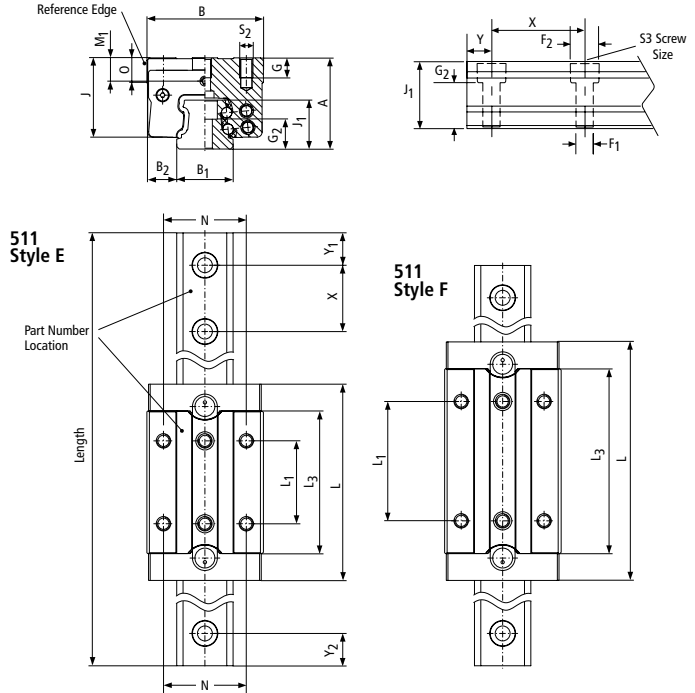
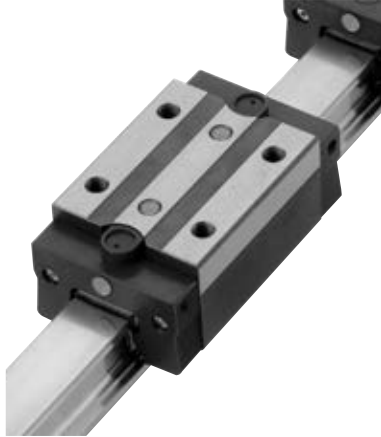

### 511 Style E Narrow High

Size	Dimensions (mm)				B <sub>2</sub>	J	J <sub>1</sub>	L	L <sub>1</sub>	L <sub>3</sub>	X	N	S <sub>2</sub> /S <sub>3</sub>	F <sub>1</sub>	F <sub>2</sub>	Ball Ø	G	G <sub>2</sub>	M <sub>1</sub>	O
	A	B	B <sub>1</sub> *	B <sub>1</sub> *																
15	28	34	15	9.5	24.2	15.7	56.6	26	39.6	60	26	M 4	4.5	8	3.2	6	9.5	8	6	
25	40	48	23	12.5	34.5	22.7	84.5	35	59.5	60	35	M 6	7	11	4.8	9	14	9.5	11	
30	45	60	28	16	38.9	26	97.4	40	69.4	80	40	M 8	9	15	5.6	11	14.5	10	11	
35	55	70	34	18	48	29.5	111.6	50	79.6	80	50	M 8	9	15	6.4	12	18	14	15	
45	70	86	45	20.5	60.8	37	137.1	60	99.1	105	60	M 10	14	20	7.9	18	22	18	19	

### 511 Style F Narrow Long High

Size	Dimensions (mm)				B <sub>2</sub>	J	J <sub>1</sub>	L	L <sub>1</sub>	L <sub>3</sub>	X	N	S <sub>2</sub> /S <sub>3</sub>	F <sub>1</sub>	F <sub>2</sub>	Ball Ø	G	G <sub>2</sub>	M <sub>1</sub>	O
	A	B	B <sub>1</sub> *	B <sub>1</sub> *																
25	40	48	23	12.5	34.5	22.7	103.5	50	78.5	60	35	M 6	7	11	4.8	9	14	9.5	11	
30	45	60	28	16	38.9	26	119.4	60	91.4	80	40	M 8	9	15	5.6	11	14.5	10	11	
35	55	70	34	18	48	29.5	137.1	72	105.1	80	50	M 8	9	15	6.4	12	18	14	15	
45	70	86	45	20.5	60.8	37	168.6	80	130.6	105	60	M 10	14	20	7.9	18	22	18	19	

\* Standard tolerance shown, special lower tolerances are available upon request. Please consult application engineering for additional information.

# 500 Series Ball

## 511 Style E and F

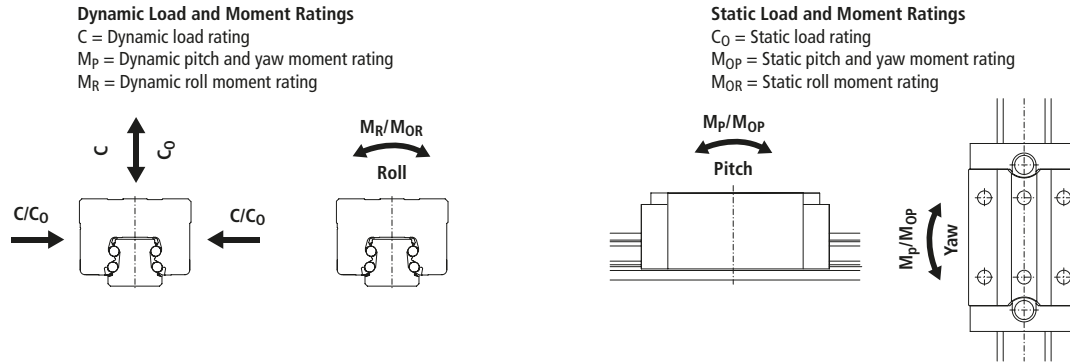

511 Style	Size	Load Rating									Weights	
		Static			Dynamic						Carriage (kg)	Rail (kg/m)
		C0 (N)	MOR (Nm)	MoP, oY (Nm)	100 Km			50 Km				
C (N)	MR (Nm)				Mp, Y (Nm)	C (N)	MR (Nm)	Mp, Y (Nm)				
E	15	19 600	181	146	9 000	83	67	11 339	105	84	0.2	1.4
	25	46 100	631	513	21 100	289	235	26 584	364	296	0.5	2.2
	30	63 700	1 084	829	29 200	497	380	36 790	626	479	0.7	3.0
	35	84 400	1 566	1 252	38 700	718	574	48 759	905	723	1.2	4.3
	45	134 800	3 193	2 498	61 900	1 466	1 147	77 989	1 847	1 445	1.8	5.4
F	25	60 300	825	863	25 500	349	365	32 128	440	460	0.6	2.2
	30	83 300	1 414	1 390	35 300	599	589	44 475	755	742	0.9	3.0
	35	110 300	2 048	2 104	46 700	867	891	58 838	1 092	1 123	1.5	4.3
	45	176 300	4 175	4 199	74 700	1 769	1 779	94 116	2 229	2 241	2.3	5.4

1. The dynamic load and moment ratings are based on the travel life specified on the table (100 km or 50 km). When comparing these load ratings with other bearings you must take into consideration the proper travel life basis.

2. The static load and moment ratings are the maximum radial load and moment load that should be applied to the bearing when there is no relative motion between the carriage and the rail.

### Bearing Travel Life Calculation

$$L = (C/F)^3 \times 100 \text{ km}$$

where:

L = travel life, km

C = 100 km dynamic load rating

F = applied dynamic load, N

$$C_{\min} = \left(\frac{L}{100}\right)^{1/3} F$$

where:

C<sub>min</sub> = minimum required

dynamic load rating, N

F = applied dynamic load, N

L = required travel life, km

#### Operating Parameters:

Maximum Velocity: 5 m/s

Maximum Acceleration: 100 m/s<sup>2</sup>

Temperature: Min: -40° C

Max: 80° C

Max peak: 120° C short time\*

\*without bellows

Conversion Factors: See Page 150

## 500 Series Ball Profile Rail Linear Guide

### 511 Style G

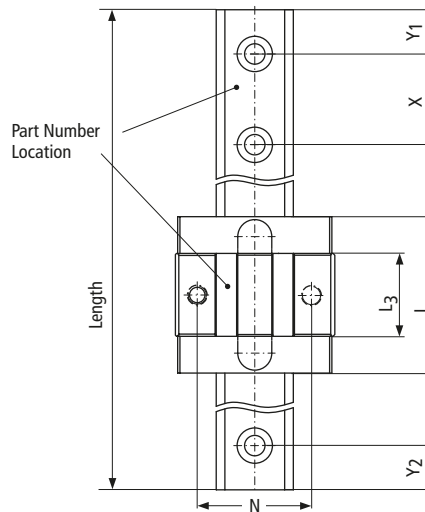
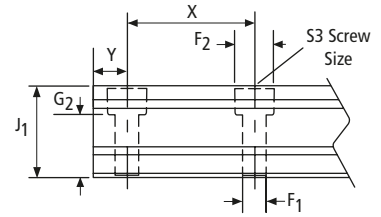
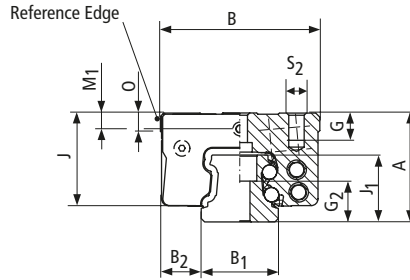
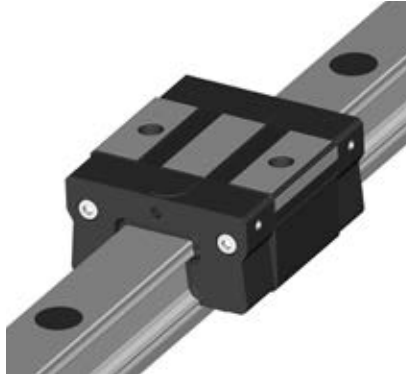

### 511 Style G Narrow Short

Size	Dimensions (mm)				J	J <sub>1</sub>	L	L <sub>3</sub>	X	N	s <sub>2</sub> /s <sub>3</sub>	F <sub>1</sub>	F <sub>2</sub>	Ball Ø	G	G <sub>2</sub>	M <sub>1</sub>	O
	A	B +0.0 -0.4	B <sub>1</sub> * +0.05	B <sub>2</sub>														
15	24	34	15	9.5	20.2	15.7	37.6	20.6	60	26	M4	4.5	8	3.2	6	9.5	4	6
20	28	44	20	12	23.5	19	47.7	25.7	60	32	M5	5.8	10	4.0	6	11.5	4.2	4

\* Standard tolerance shown, special lower tolerances are available upon request. Please consult application engineering for additional information.

\*\* When using additional modular seals or lubrication plates, the total length L will increase. Consult page 34-35 for additional information.

Length of rail to be specified at time of order, Y<sub>1</sub> will equal Y<sub>2</sub> unless specified otherwise at time of order.

# 500 Series Ball

## 511 Style G

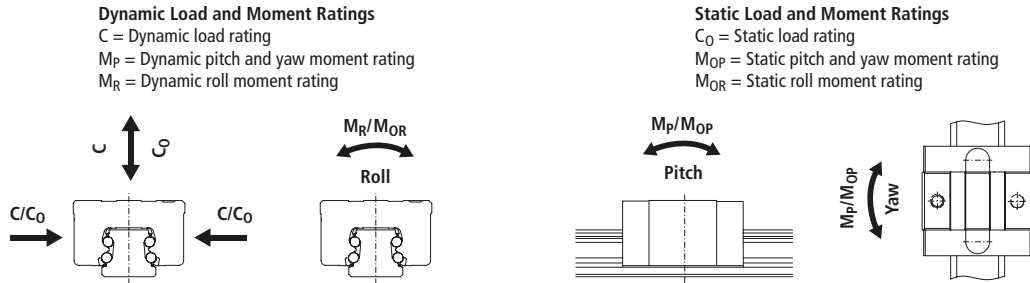

Style	Size	Load Rating									Weights	
		Static			Dynamic						Carriage	Rail
		C <sub>0</sub> (N)	M <sub>OR</sub> (Nm)	M <sub>OP, OY</sub> (Nm)	100 Km			50 Km				
					C (N)	M <sub>R</sub> (Nm)	M <sub>P, Y</sub> (Nm)	C (N)	M <sub>R</sub> (Nm)	M <sub>P, Y</sub> (Nm)	(kg)	(kg/m)
G	15	8 500	78	30	5 200	48	18	6 552	60	23	0.2	1.4
	20	13 100	150	58	8 400	99	37	10 583	125	47	0.5	2.2

- The dynamic load and moment ratings are based on the travel life specified on the table (100 km or 50 km). When comparing these load ratings with other bearings you must take into consideration the proper travel life basis.
- The static load and moment ratings are the maximum radial load and moment load that should be applied to the bearing when there is no relative motion between the carriage and the rail.
- Deflection charts are available on [www.thomsonlinear.com](http://www.thomsonlinear.com).

### Bearing Travel Life Calculation

$L = (C/F)^3 \times 100 \text{ km}$   
 where:  
 L = travel life, km  
 C = 100 km dynamic load rating  
 F = applied dynamic load, N

$C_{min} = F \left(\frac{L}{100}\right)^{1/3}$   
 where:  
 C<sub>min</sub> = minimum required dynamic load rating, N  
 F = applied dynamic load, N  
 L = required travel life, km

- Operating Parameters:**
- Maximum Velocity: 5 m/s
  - Maximum Acceleration: 100 m/s<sup>2</sup>
  - Temperature:
    - Min: - 40° C
    - Max: 80° C
    - Max peak: 120° C short time\*
- \*without bellows

Conversion Factors: See Page 150

## Carriage Dowel Holes

### Carriage Dowel Holes

Dowel holes are commonly used to ensure proper alignment during installation and replacement of carriages and rails. The standard slip fit dowel hole options for the 500 series Standard Ball Carriages are:

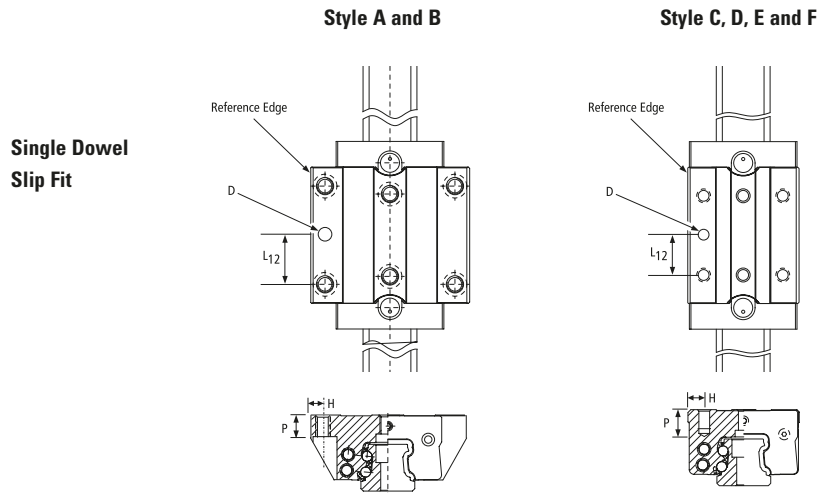

511		L <sub>12</sub>	ØD	ES1			ØD	ES2			ØD	ES3			ØD	ES4		
Style	Size			H	P	H		P	H	P		H	P	H		P		
Type A	15	15	6	4.5	7	—	—	—	1/4"	4.5	7	—	—	—	—	—	—	
	20	20	6	5	9	—	—	—	1/4"	5	9	—	—	—	—	—	—	
	25	22.5	6	6.5	9	—	—	—	1/4"	6.5	9	—	—	—	—	—	—	
	30	26	6	9	12	10	9	12	1/4"	9	12	3/8"	9	12	3/8"	9	14	
	35	31	—	—	—	10	9	14	—	—	—	3/8"	9	14	—	—	—	
45	40	—	—	—	10	10	18	—	—	—	3/8"	10	18	—	—	—		
Type B	20	20	6	5	9	—	—	—	1/4"	5	9	—	—	—	—	—	—	
	25	22.5	6	6.5	9	—	—	—	1/4"	6.5	9	—	—	—	—	—	—	
	30	26	6	9	12	10	9	12	1/4"	9	12	3/8"	9	12	3/8"	9	14	
	35	31	—	—	—	10	9	14	—	—	—	3/8"	9	14	—	—	—	
	45	40	—	—	—	10	10	18	—	—	—	3/8"	10	18	—	—	—	
Type C	15	13	6	4	6	—	—	—	1/4"	4	6	—	—	—	—	—	—	
	20	18	6	6	9	—	—	—	1/4"	6	9	—	—	—	—	—	—	
	25	17.5	6	6.5	9	—	—	—	1/4"	6.5	9	—	—	—	—	—	—	
	30	20	6	10	12	10	10	12	1/4"	10	12	3/8"	10	12	3/8"	10	12	
	35	25	—	—	—	10	10	12	—	—	—	3/8"	10	12	—	—	—	
Type D	20	25	6	6	9	—	—	—	1/4"	6	9	—	—	—	—	—	—	
	25	25	6	6.5	9	—	—	—	1/4"	6.5	9	—	—	—	—	—	—	
	30	30	6	10	12	10	10	12	1/4"	10	12	3/8"	10	12	3/8"	10	12	
	35	36	—	—	—	10	10	12	—	—	—	3/8"	10	12	—	—	—	
Type E	15	13	6	4	6	—	—	—	1/4"	4	6	—	—	—	—	—	—	
	25	17.5	6	6.5	9	—	—	—	1/4"	6.5	9	—	—	—	—	—	—	
	30	20	6	10	12	10	10	12	1/4"	10	12	3/8"	10	12	3/8"	10	12	
	35	25	—	—	—	10	10	12	—	—	—	3/8"	10	12	—	—	—	
	45	30	—	—	—	10	13	12	—	—	—	3/8"	13	12	—	—	—	
Type F	25	25	6	6.5	9	—	—	—	1/4"	6.5	9	—	—	—	—	—	—	
	30	30	6	10	12	10	10	12	1/4"	10	12	3/8"	10	12	3/8"	10	12	
	35	36	—	—	—	10	10	12	—	—	—	3/8"	10	12	—	—	—	
	45	40	—	—	—	10	13	12	—	—	—	3/8"	13	12	—	—	—	

All dimension in mm, unless otherwise specified.  
Hole tolerance  $\text{øD} +0.013/-0$

# Carriage Dowel Holes

## Carriage Dowel Holes (continued)

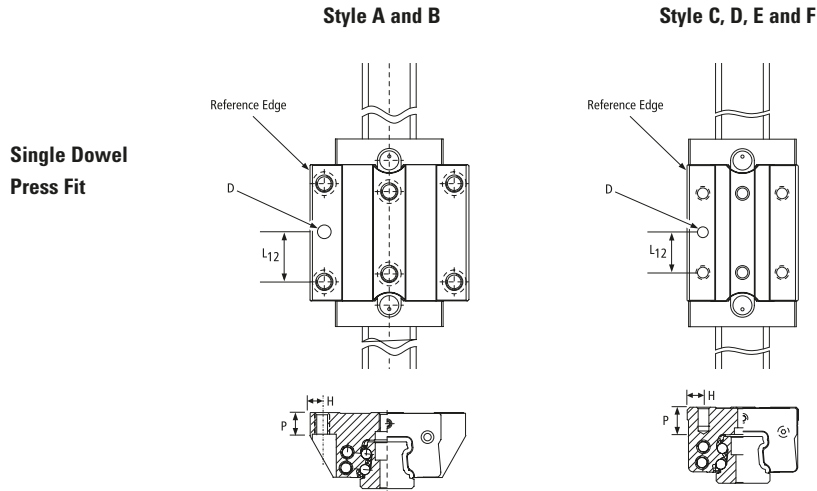

511		L <sub>12</sub>	ES12			ES13			ES14			ES15		
Style	Size		ØD	H	P	ØD	H	P	ØD	H	P	ØD	H	P
Type A	15	15	6	4.5	7	—	—	—	1/4"	4.5	7	—	—	—
	20	20	6	5	9	—	—	—	1/4"	5	9	—	—	—
	25	22.5	6	6.5	9	—	—	—	1/4"	6.5	9	—	—	—
	30	26	6	9	12	10	9	12	1/4"	9	12	3/8"	9	12
	35	31	—	—	—	10	9	14	—	—	—	3/8"	9	14
	45	40	—	—	—	10	10	18	—	—	—	3/8"	10	18
Type B	20	20	6	5	9	—	—	—	1/4"	5	9	—	—	—
	25	22.5	6	6.5	9	—	—	—	1/4"	6.5	9	—	—	—
	30	26	6	9	12	10	9	12	1/4"	9	12	3/8"	9	12
	35	31	—	—	—	10	9	14	—	—	—	3/8"	9	14
	45	40	—	—	—	10	10	18	—	—	—	3/8"	10	18
Type C	15	13	6	4	6	—	—	—	1/4"	4	6	—	—	—
	20	18	6	6	9	—	—	—	1/4"	6	9	—	—	—
	25	17.5	6	6.5	9	—	—	—	1/4"	6.5	9	—	—	—
	30	20	6	10	12	10	10	12	1/4"	10	12	3/8"	10	12
	35	25	—	—	—	10	10	12	—	—	—	3/8"	10	12
Type D	20	25	6	6	9	—	—	—	1/4"	6	9	—	—	—
	25	25	6	6.5	9	—	—	—	1/4"	6.5	9	—	—	—
	30	30	6	10	12	10	10	12	1/4"	10	12	3/8"	10	12
	35	36	—	—	—	10	10	12	—	—	—	3/8"	10	12
Type E	15	13	6	4	6	—	—	—	1/4"	4	6	—	—	—
	25	17.5	6	6.5	9	—	—	—	1/4"	6.5	9	—	—	—
	30	20	6	10	12	10	10	12	1/4"	10	12	3/8"	10	12
	35	25	6	10	12	10	10	12	1/4"	10	12	3/8"	10	12
	45	30	6	13	12	10	13	12	1/4"	13	12	3/8"	13	12
Type F	25	25	6	6.5	9	—	—	—	1/4"	6.5	9	—	—	—
	30	30	6	10	12	10	10	12	1/4"	10	12	3/8"	10	12
	35	36	—	—	—	10	10	12	—	—	—	3/8"	10	12
	45	40	—	—	—	10	13	12	—	—	—	3/8"	13	12

All dimension in mm, unless otherwise specified.  
Hole tolerance  $\varnothing D +0 / -0.013$

## Lubrication Inlet Options

The standard carriage is supplied with a lubrication inlet centered over the rail. The carriage has multiple lubrication inlet point options. The options can be easily modified on-site in the field or can be supplied factory direct (Standard inlet hole is M3 for 15 mm, M6 for 20 mm, 25 mm, 30 mm 35 mm, 45 mm). See page 71 for available lubrication fittings.

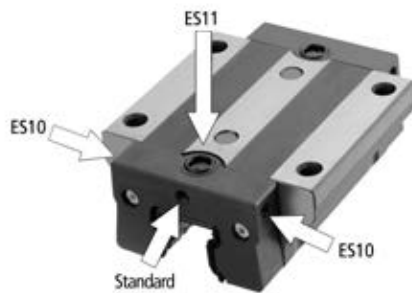

### Option

- ES10 Inlets on side – both ends– all sides
- ES11 Inlet on top\* – both ends

### Notes:

1. \*An O-Ring is required to properly seat the mating surfaces to prevent grease or oil from escaping. One is supplied with this option. Size 15 O-ring ID M3 x 1.78mm thick. Sizes 20–45 O-ring ID M6 x 1.78mm thick.
2. Set screw is installed in Standard inlet hole when ES10 and ES11 options are specified.
3. Inlets on side and top are solid plugs. When modified on-site, inlets must be punctured to be utilized.

### Lubrication inlet locates standard and ES10 option.

Size	Style	M1	M3	M4	D1	D2
15	A	4	4	4	M3	M3
	C	8	8			
	E	8	8			
	G	4	4			
20	A	5.2	5.2	5.2	M6	M3
	B					
	C					
	D					
	G	4.2	4.2	5	M3	M3
25	A	5.5	5.5	6	M6	M6
	B					
	C					
	D					
	E	9.5	9.5			
	F					
30	A	7	7	6	M6	M6
	B					
	C					
	D					
	E	10	10			
	F					
35	A	7	7	6	M6	M6
	B					
	C					
	D					
	E	14	14			
	F					
45	A	8	8	7.5	M6	M6
	B					
	E	18	18			
	F					

All dimensions in mm unless specified.

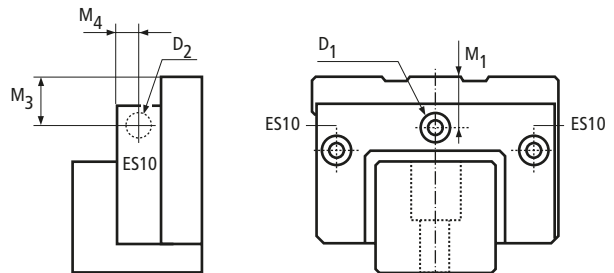

1. D1 and D2 are threaded holes in the end cap to ensure proper integrity and durability of connection.
2. Carriages are shipped with a grease fitting in the box. Size 15 and all G style carriages include fitting 530LF3, Size 20 and up include fitting 530LN. See page 71 for more information.



## Lubrication Inlet Options

### Lubrication inlet location ES11 option

Size	Style	C7	D1	D2	D3	D4
15	A	8.000	4.47	8	1.78	4
	C	10.000				
	E	10.000				
20	A	10.500	6.75	10	1.78	6
	B	18.500				
	C	12.500				
	D	13.500				
25	A	13.200	8.75	12	1.78	8
	B	22.700				
	C	18.200				
	D	20.200				
	E	18.200				
	F	20.200				
30	A	13.200	8.75	12	1.78	8
	B	22.700				
	C	18.200				
	D	20.200				
	E	18.200				
	F	20.200				
35	A	14.500	8.75	12	1.78	8
	B	27.250				
	C	20.500				
	D	22.250				
	E	20.500				
	F	22.250				
45	A	17.000	8.75	12	1.78	8
	B	32.750				
	E	27.000				
	F	32.750				

All dimensions in mm.

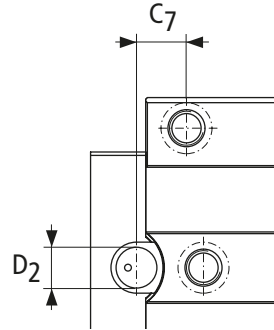

- D1** = O-Ring internal diameter
- D2** = Counterbore diameter
- D3** = O-Ring thickness
- D4** = Max. recommended diameter of lubrication inlet from above plate

## Grease Lubricants

Standard carriages are sold with oil preservative to protect the balls from corrosion during storage and transit. The carriages are available with the following assortment of lubricants. Additional greases are available upon request, please consult Thomson Application Engineering.

Option	Type	Notes	Viscosity	Temperature Range
G1	Mobilux® EP2	All purpose NLG I2 grease	160cSt @40°C	-20°C to 130°C
G2	Krytox® GPL227	High Temperature NLG I2	440cSt @40°C	-30°C to 288°C
G3	Thomson LinearLube	Food Grade NLG I2 grease	350cSt @40°C	-54°C to 230°C
GS	Customer specified at time of order			

## Rail Length

### Maximum Length of One Piece Rail

Size (mm)	15	20	25	30	35	45
One Piece Rail Length	3000 mm		6000 mm			

### Extended Standard Rail Options

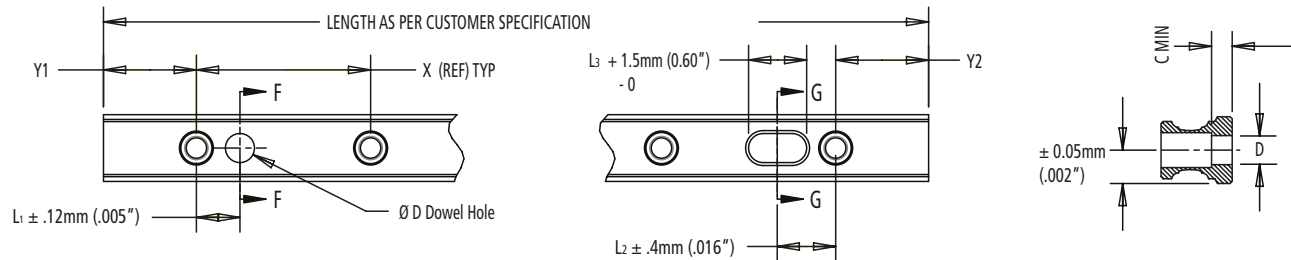

Option	D	L1	L2	L3	C
DH1	6mm	30mm	30mm	10.2 mm	9.5 mm
DH2	10mm	30mm	30mm	13.8 mm	9.5 mm
DH3	1/4"	1.181"	1.181"	.542"	3/8"
DH4	3/8"	1.181"	1.181"	.542"	3/8"

Y1 = Y2 unless specified at time of ordering

\*Size 25 and up step will be present around bottom of slot to control width tolerance during milling of slot.

The rail can be supplied with dowel holes, radial holes and coaxial holes to meet your application needs. Please provide a drawing of your requirement and our Application Engineering Team can provide a quote or select one of our extended standard options.

### 521 Type U Rail – Bolt Up From Bottom

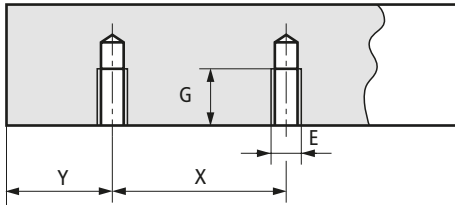

Size	X	E	G (mm)	Weight (kg/m)
15	60	M5	8	1.4
20	60	M6	10	2.2
25	60	M6	12	3
30	80	M8	15	4.3
35	80	M8	15	5.4
45	105	M12	19	8.8

Customer to specify Y dimensions upon ordering  $Y_1 = Y_2$  if not specified

### Thin Dense Chrome Plating

Rails and carriages are available with Thin Dense Chrome Plating with a thickness of 2–4 µm. As a result of the plating thickness range compared to the tolerance ranges in the different accuracy classes, it is only available in the High and Precision accuracy classes up to 3 meters long as a single rail; longer lengths require butt joints.

### Carriage assortment with Thin Dense Chrome

Type	Style	Size	Accuracy	Clearance	Preload			
					0.03C	0.08C	0.13C	
511	A	15	H	511H15A0D	511H15A1D	511H15A2D	-	
			P	-	511P15A1D	511P15A2D	511P15A3D	
		20	H	511H20A0D	511H20A1D	511H20A2D	-	
			P	-	511P20A1D	511P20A2D	511P20A3D	
		25	H	511H25A0D	511H25A1D	511H25A2D	-	
			P	-	511P25A1D	511P25A2D	511P25A3D	
		30	H	511H30A0D	511H30A1D	511H30A2D	-	
			P	-	511P30A1D	511P30A2D	511P30A3D	
		35	H	511H35A0D	511H35A1D	511H35A2D	-	
			P	-	511P35A1D	511P35A2D	511P35A3D	
		45	H	511H45A0D	511H45A1D	511H45A2D	-	
			P	-	511P45A1D	511P45A2D	511P45A3D	
	B	20	H	511H20B0D	511H20B1D	511H20B2D	-	
			P	-	511P20B1D	511P20B2D	511P20B3D	
		25	H	511H25B0D	511H25B1D	511H25B2D	-	
			P	-	511P25B1D	511P25B2D	511P25B3D	
		30	H	511H30B0D	511H30B1D	511H30B2D	-	
			P	-	511P30B1D	511P30B2D	511P30B3D	
		35	H	511H35B0D	511H35B1D	511H35B2D	-	
			P	-	511P35B1D	511P35B2D	511P35B3D	
		45	H	511H45B0D	511H45B1D	511H45B2D	-	
			P	-	511P45B1D	511P45B2D	511P45A3D	
		C	15	H	511H15C0D	511H15C1D	511H15C2D	-
				P	-	511P15C1D	511P15C2D	511P15C3D
20	H		511H20C0D	511H20C1D	511H20C2D	-		
	P		-	511P20C1D	511P20C2D	511P20C3D		
25	H		511H25C0D	511H25C1D	511H25C2D	-		
	P		-	511P25C1D	511P25C2D	511P25C3D		
30	H		511H30C0D	511H30C1D	511H30C2D	-		
	P		-	511P30C1D	511P30C2D	511P30C3D		
35	H		511H35C0D	511H35C1D	511H35C2D	-		
	P		-	511P35C1D	511P35C2D	511P35C3D		

Type	Style	Size	Accuracy	Clearance	Preload			
					0.03C	0.08C	0.13C	
511	D	20	H	511H20D0D	511H20D1D	511H20D2D	-	
			P	-	511P20D1D	511P20D2D	511P20D3D	
		25	H	511H25D0D	511H25D1D	511H25D2D	-	
			P	-	511P25D1D	511P25D2D	511P25D3D	
		30	H	511H30D0D	511H30D1D	511H30D2D	-	
			P	-	511P30D1D	511P30D2D	511P30D3D	
		35	H	511H35D0D	511H35D1D	511H35D2D	-	
			P	-	511P35D1D	511P35D2D	511P35D3D	
		E	15	H	511H15E0D	511H15E1D	511H15E2D	-
				P	-	511P15E1D	511P15E2D	511P15E3D
			25	H	511H25E0D	511H25E1D	511H25E2D	-
				P	-	511P25E1D	511P25E2D	511P25E3D
	30		H	511H30E0D	511H30E1D	511H30E2D	-	
			P	-	511P30E1D	511P30E2D	511P30E3D	
	35		H	511H35E0D	511H35E1D	511H35E2D	-	
			P	-	511P35E1D	511P35E2D	511P35E3D	
	F		45	H	511H45E0D	511H45E1D	511H45E2D	-
				P	-	511P45E1D	511P45E2D	511P45E3D
			25	H	511H25F0D	511H25F1D	511H25F2D	-
				P	-	511P25F1D	511P25F2D	511P25F3D
		30	H	511H30F0D	511H30F1D	511H30F2D	-	
			P	-	511P30F1D	511P30F2D	511P30F3D	
		35	H	511H35F0D	511H35F1D	511H35F2D	-	
			P	-	511P35F1D	511P35F2D	511P35F3D	
		G	45	H	511H45F0D	511H45F1D	511H45F2D	-
				P	-	511P45F1D	511P45F2D	511P45F3D
			15	H	511H15G0D	511H15G1D	511H15G2D	-
				P	-	511P15G1D	511P15G2D	511P15G3D
	20		H	511H20G0D	511H20G1D	511H20G2D	-	
			P	-	511P20G1D	511P20G2D	511P20G3D	

Chrome plated carriages and rails are designed and manufactured to be used together. If a non-chrome plated carriage is used on a chrome plated rail the clearance or preload of the carriage will be increased approximately one class. If a chrome plated carriage is used on a non-chrome plated rail the clearance or preload will be decreased approximately one class. This is the result of the coating thickness.

## Modular Accessory Combination Options and Screw Size

Option	Description	Size					
		15		20		25	
L <sup>3</sup>	"Lube for Life" Lube Block	Low/socket head screw	M2.5-0.45x20	Low/socket head screw	M2.5-0.45x25	Low/socket head screw	M4-0.7x35
N <sup>3</sup>	Oil Reservoir	Low/socket head screw	M2.5-0.45x20	Low/socket head screw	M2.5-0.45x25	Low/socket head screw	M4-0.7x30
V <sup>3</sup>	Viton Wiper	Low/socket head screw	M2.5-0.45x20	Low/socket head screw	M2.5-0.45x20	Low/socket head screw	M4-0.7x25
Z <sup>3</sup>	Metal Scraper	Low/socket head screw	M2.5-0.45x15	Low/socket head screw	M2.5-0.45x15	Low/socket head screw	M4-0.7x20
C <sup>3</sup>	Bellows Clips	Flat/socket head screw	M2.5-0.45x15	Flat/socket head screw	M2.5-0.45x15	Flat/socket head screw	M4-0.7x20
LV	Lube Block + Wiper	Low/socket head screw	M2.5-0.45x25	Low/socket head screw	M2.5-0.45x30	Low/socket head screw	M4-0.7x35
LVC	Lube Block, Wiper + Bellows Clip	Flat/socket head screw	M2.5-0.45x25	Flat/socket head screw	M2.5-0.45x30	Flat/socket head screw	M4-0.7x35
LVZ	Lube Block, Wiper + Scraper	Low/socket head screw	M2.5-0.45x25	Low/socket head screw	M2.5-0.45x30	Low/socket head screw	M4-0.7x35
LVZC	Lube Block, Wiper, Scraper + Bellows Clip	Flat/socket head screw	M2.5-0.45x25	Flat/socket head screw	M2.5-0.45x30	Flat/socket head screw	M4-0.7x35
LZ	Lube Block + Scraper	Low/socket head screw	M2.5-0.45x20	Low/socket head screw	M2.5-0.45x25	Low/socket head screw	M4-0.7x35
LZC	Lube Block, Scraper + Bellows Clip	Flat/socket head screw	M2.5-0.45x20	Flat/socket head screw	M2.5-0.45x25	Flat/socket head screw	M4-0.7x35
LC	Lube Block + Bellows Clip	Flat/socket head screw	M2.5-0.45x20	Flat/socket head screw	M2.5-0.45x25	Flat/socket head screw	M4-0.7x35
NV	Oil Reservoir + Wiper	Low/socket head screw	M2.5-0.45x30	Low/socket head screw	M2.5-0.45x30	Low/socket head screw	M4-0.7x40
NVZ	Oil Reservoir, Wiper + Scraper	Low/socket head screw	M2.5-0.45x30	Low/socket head screw	M2.5-0.45x35	Low/socket head screw	M4-0.7x40
NVC	Oil Reservoir, Wiper + Bellows Clip	Flat/socket head screw	M2.5-0.45x30	Flat/socket head screw	M2.5-0.45x30	Flat/socket head screw	M4-0.7x40
NVZC	Oil Reservoir, Wiper, Scraper + Bellows Clip	Flat/socket head screw	M2.5-0.45x30	Flat/socket head screw	M2.5-0.45x35	Flat/socket head screw	M4-0.7x40
NZ	Oil Reservoir + Scraper	Low/socket head screw	M2.5-0.45x25	Low/socket head screw	M2.5-0.45x30	Low/socket head screw	M4-0.7x35
NZC	Oil Reservoir, Scraper + Bellows Clips	Flat/socket head screw	M2.5-0.45x25	Flat/socket head screw	M2.5-0.45x30	Flat/socket head screw	M4-0.7x35
NC	Oil Reservoir + Bellows Clips	Flat/socket head screw	M2.5-0.45x20	Flat/socket head screw	M2.5-0.45x25	Flat/socket head screw	M4-0.7x35
VC	Wiper + Bellows Clip	Flat/socket head screw	M2.5-0.45x20	Flat/socket head screw	M2.5-0.45x20	Flat/socket head screw	M4-0.7x25
VZC	Wiper, Scraper + Bellows Clip	Flat/socket head screw	M2.5-0.45x20	Flat/socket head screw	M2.5-0.45x25	Flat/socket head screw	M4-0.7x30
VZ	Viton Wiper + Scraper	Low/socket head screw	M2.5-0.45x20	Low/socket head screw	M2.5-0.45x25	Low/socket head screw	M4-0.7x25
ZC	Scraper + Bellows Clip	Flat/socket head screw	M2.5-0.45x15	Flat/socket head screw	M2.5-0.45x15	Flat/socket head screw	M4-0.7x20

1. All fasteners are standard threads.
2. Consult Thomson for options not listed, engineering review is required.
3. When ordering component only, two screws include.

Option	Description	Size					
		30		35		45	
L	"Lube for Life" Lube Block	Low/socket head screw	M4-0.7x40	Low/socket head screw	M4-0.7x45	Low/socket head screw	M5-0.8x50
N	Oil Reservoir	Low/socket head screw	M4-0.7x30	Low/socket head screw	M4-0.7x35	Low/socket head screw	M5-0.8x45
V	Viton Wiper	Low/socket head screw	M4-0.7x25	Low/socket head screw	M4-0.7x30	Low/socket head screw	M5-0.8x35
Z	Metal Scraper	Low/socket head screw	M4-0.7x20	Low/socket head screw	M4-0.7x25	Low/socket head screw	M5-0.8x30
C	Bellows Clips	Flat/socket head screw	M4-0.7x20	Flat/socket head screw	M4-0.7x25	Flat/socket head screw	M5-0.8x30
LV	Lube Block + Wiper	Low/socket head screw	M4-0.7x40	Low/socket head screw	M4-0.7x45	Low/socket head screw	M5-0.8x50
LVC	Lube Block, Wiper + Bellows Clip	Flat/socket head screw	M4-0.7x40	Flat/socket head screw	M4-0.7x45	Flat/socket head screw	M5-0.8x50
LVZ	Lube Block, Wiper + Scraper	Low/socket head screw	M4-0.7x40	Low/socket head screw	M4-0.7x45	Low/socket head screw	M5-0.8x50
LVZC	Lube Block, Wiper, Scraper + Bellows Clip	Flat/socket head screw	M4-0.7x40	Flat/socket head screw	M4-0.7x45	Flat/socket head screw	M5-0.8x50
LZ	Lube Block + Scraper	Low/socket head screw	M4-0.7x40	Low/socket head screw	M4-0.7x45	Low/socket head screw	M5-0.8x50
LZC	Lube Block, Scraper + Bellows Clip	Flat/socket head screw	M4-0.7x40	Flat/socket head screw	M4-0.7x45	Flat/socket head screw	M5-0.8x50
LC	Lube Block + Bellows Clip	Flat/socket head screw	M4-0.7x40	Flat/socket head screw	M4-0.7x45	Flat/socket head screw	M5-0.8x50
NV	Oil Reservoir + Wiper	Low/socket head screw	M4-0.7x40	Low/socket head screw	M4-0.7x45	Low/socket head screw	M5-0.8x50
NVZ	Oil Reservoir, Wiper + Scraper	Low/socket head screw	M4-0.7x40	Low/socket head screw	M4-0.7x45	Low/socket head screw	M5-0.8x55
NVC	Oil Reservoir, Wiper + Bellows Clip	Flat/socket head screw	M4-0.7x40	Flat/socket head screw	M4-0.7x45	Flat/socket head screw	M5-0.8x55
NVZC	Oil Reservoir, Wiper, Scraper + Bellows Clip	Flat/socket head screw	M4-0.7x45	Flat/socket head screw	M4-0.7x50	Flat/socket head screw	M5-0.8x55
NZ	Oil Reservoir + Scraper	Low/socket head screw	M4-0.7x35	Low/socket head screw	M4-0.7x40	Low/socket head screw	M5-0.8x45
NZC	Oil Reservoir, Scraper + Bellows Clips	Flat/socket head screw	M4-0.7x35	Flat/socket head screw	M4-0.7x40	Flat/socket head screw	M5-0.8x50
NC	Oil Reservoir + Bellows Clips	Flat/socket head screw	M4-0.7x35	Flat/socket head screw	M4-0.7x40	Flat/socket head screw	M5-0.8x50
VC	Wiper + Bellows Clip	Flat/socket head screw	M4-0.7x25	Flat/socket head screw	M4-0.7x30	Flat/socket head screw	M5-0.8x35
VZC	Wiper, Scraper + Bellows Clip	Flat/socket head screw	M4-0.7x30	Flat/socket head screw	M4-0.7x30	Flat/socket head screw	M5-0.8x35
VZ	Wiper + Scraper	Low/socket head screw	M4-0.7x25	Low/socket head screw	M4-0.7x30	Low/socket head screw	M5-0.8x35
ZC	Scraper + Bellows Clip	Flat/socket head screw	M4-0.7x20	Flat/socket head screw	M4-0.7x25	Flat/socket head screw	M5-0.8x30

Consult Thomson for options not listed, engineering review required.

## Modular Accessories



### Additional Wiper

Size	Viton® Part No.	L1 (mm)	L2 (mm)	Weight (kg)
15	531VR15	7	4	0.005
20	531VR20	7	4	0.008
25	531VR25	7	4	0.010
30	531VR30	7	4	0.016
35	531VR35	7	4	0.022
45	531VR45	7	4	0.036

L1 – wiper thickness, L2 – max. screw head stickout  
Can be installed without removing carriage from rail

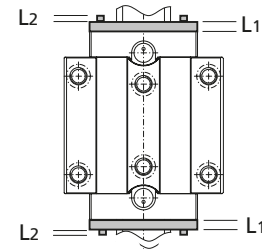

### Metal Scraper

Size	Scraper Part No.	L1 (mm)	L2 (mm)	Weight (kg)
15	531ZZ15	1.5	4	0.005
20	531ZZ20	1.5	4	0.009
25	531ZZ25	1.5	4	0.011
30	531ZZ30	1.5	4	0.018
35	531ZZ35	1.5	4	0.024
45	531ZZ45	1.5	4	0.057

L1 – scraper thickness, L2 – max. screw head stickout

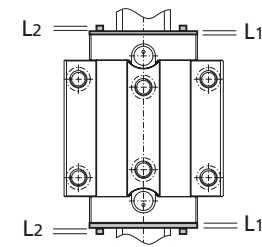

### Oil Reservoir

Size	Lubrication Plate	L1 (mm)	Weight (kg)
15	531OW15	8.5	0.004
20	531OW20	11	0.010
25	531OW25	12.7	0.017
30	531OW30	14	0.023
35	531OW35	16.2	0.039
45	531OW45	19.2	0.065

L1 = Oil reservoir thickness, screw heads are recessed in plate

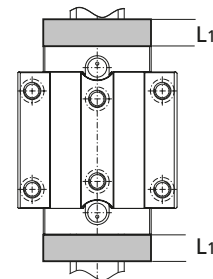

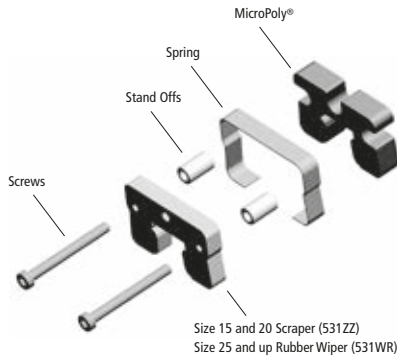

**Lube Block**

Size	Lubrication Plate	L1 (mm)	L2 (mm)	Weight (kg)
15	531 LL 15	9.9	4	0.009
20	531 LL 20	11.9	4	0.024
25	531 LL 25	19.5	4	0.083
30	531 LL 30	21.2	4	0.213
35	531 LL 35	24.7	4	0.069
45	531 LL 45	26.9	4	0.123

L1 = Lube Block thickness, L2 = max. screw head stickout

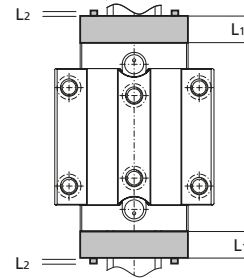

When supplied from the factory as a complete unit the carriage is packed with EP2 grease and spring is loose for customer to install after assembling carriage on the rail.

Z scraper included in lube block assembly on sizes 15 and 20.  
W wiper included on sizes 25 and up.

**Example**

511 Size 45 carriage with 531OW and 531WR modular seals on both sides:	
Carriage Length (L)	= 89.3
531 OW 45 L <sub>1</sub> x 2	= 12.7 x 2
531 WR 45 L <sub>1</sub> x 2	= 7 x 2
531 WR 45 L <sub>2</sub> x 2	= 4 x 2
Total Length	= 136.7 mm

Each modular seal is supplied with the proper screws to install the seal over the standard end cap. When combinations of

modular seals are used longer screws may be required, consult table on page 34 & 35 for proper screw size.

## Bellows Dimensional Information

Bellows are available in three styles:

**531 BB** “Low Profile” with outside dimensions that do not exceed the carriage, constructed of polyurethane coated polyester, maximum ambient temperature of 80°C (175°F).

**531 BC** “High Compression” constructed of a spark resistant Teflon<sup>®</sup> coated fiberglass and designed to allow for higher compression, maximum ambient temperature exceeds maximum bearing peak temperatures.

**531 WC** “Walk On” capable of handling the harshest environments, including welding and grinding applications, with a 90 kg load bearing capacity.

The bellows can be easily installed in conjunction with the other optional modular seals providing you with an easy upgrade to the standard seal. Installation is simple and requires little time. Retrofitting is possible. The rail ends have to be drilled for the attachment of the bellow clip adapter plate, 531 CR. These can be easily installed on-site in the field or can be supplied from the factory.

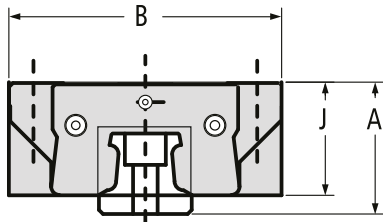

### 531 BB “Low Profile” Bellows

Size	Part No.	B	J	A	CR
15	531 BB15	45	23	26	0.17
20	531 BB20	41.6	24	29	0.17
25	531 BB25	43.7	29	35.5	0.17
30	531 BB30	51.2	33.3	40.3	0.17
35	531 BB35	64	39.5	47.5	0.15
45	531 BB45	76	48	58	0.15

Customer to specify extended length at time of order, see page 140 for how to calculate.

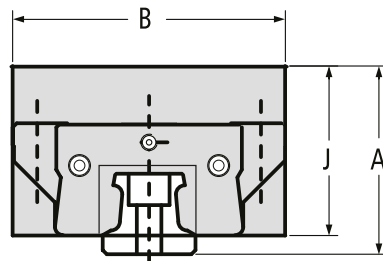

### 531 BC “High Compression” Bellows

Size	Part No.	B	J	A	CR
15	531 BC15	59	33	36	0.10
20	531 BC20	61.6	34	39	0.10
25	531 BC25	63.7	39	45.5	0.10
30	531 BC30	71.5	43.3	50.3	0.10
35	531 BC35	84	49.5	57.5	0.07
45	531 BC45	76	58	68	0.07

Customer to specify extended length at time of order, see page 140 for how to calculate.

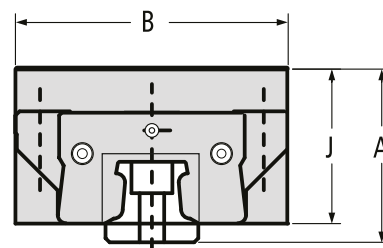

### 531 BW “Walk On” Bellows

Size	Part No.	B	J	A	CR
15	531 BW15	55	30	31	0.19
20	531 BW20	61	33	34	0.19
25	531 BW25	65	36	40.5	0.19
30	531 BW30	70	39	44.2	0.19
35	531 BW35	77	42	48	0.19
45	531 BW45	101	53	61	0.15

Customer to specify extended length at time of order, see page 140 for how to calculate.



## Bellow Clip Adapter Plates

### 531 CC Carriage Bellows Clips – Attachment Plate

The 531 CC Carriage Bellows Clip – Attachment Plate is used to attach the bellows to the carriage. The bellows clip – adapter plate is made of steel.

Size	Part No.
15	531 CC15
20	531 CC20
25	531 CC25
30	531 CC30
35	531 CC35
45	531 CC45

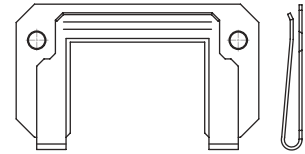

### 531 CR Rail Bellows Clips – Attachment Plate

The 531 CR Rail Bellow Clip – Attachment Plate is used to attach the bellows to the rail. The attaching holes can be drilled in the end of the rail if retrofitting or can be supplied from the factory. (Note: Size 15 rail is through hardened, annealing the end of the rail is required to properly drill end plate clip this results in an area on the end of the rail that will be soft and possibly out of tolerance). The bellows clip – adapter plate is made of steel.

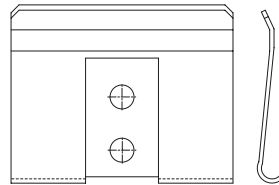

Size	Part No.	Rail Machining Detail					Screw <sup>1</sup>				MinY <sup>2</sup>
		A	B	C	Depth Min	Depth Max	Size	Pitch	Length	Type	
15 <sup>3</sup>	531 CR15	3.50	8.00	7.50	5.70	7.70	M3	0.5	8	Button Head	14
20	531 CR20	5.00	8.00	10.00							15
25	531 CR25	7.24	10.00	11.50	7.70	9.70	M4	0.7	10	Cap Screw	17
30	531 CR30	9.12	10.00	14.00							20
35	531 CR35	11.00	10.00	17.00							20
45	531 CR45	15.01	10.00	22.50							22

All dimensions in mm, unless otherwise specified.

- Two screws are supplied with each Rail Bellow Clip.
- Min Y dimension to ensure drill depth does not break through rail mounting hole.
- Rail end may require annealing, see note above.

### Rail End Machine Detail

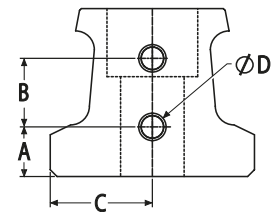

## Maintenance and Installation Tools and Accessories

The assembly rail is required when the carriage must be removed from the rail and then reinstalled to ensure proper installation. It is recommended to leave the carriage on the assembly rail when it is removed to protect the balls against contamination. If necessary, the two internal mounting screws for fastening runner blocks to the carriage can be tightened to ensure the carriage remains on the assembly rail. The assembly rail is made of plastic.

### Assembly Rail – 531 MT



Part Number	Size	Length (mm)	Weight (kg)
531 MT 15	15	80	0.010
531 MT 20	20	115	0.021
531 MT 25	25	130	0.031
531 MT 30	30	160	0.061
531 MT 35	35	165	0.076
531 MT 45	45	200	0.135

### Standard Rail Plugs and Tape for use with 500 Series Ball Carriage Type A

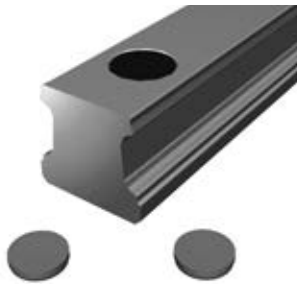

Type HP plastic plugs	Size
531 HP 15	15
531 HP 20	20
531 HP 25	25
531 HP 30	30
531 HP 35	35
531 HP 45	45

Mylar Tape	Size	Length
531 RT 15	15	3m
531 RT 20	20	3m
531 RT 25	25	3m
531 RT 30	30	3m
531 RT 35	35	3m
531 RT 45	45	3m

Material: Nylon

### 500 Series Rail with Stainless Steel Cover Strip



Size	Rail Coverstrip End Caps Part Number <sup>1</sup>	Mounting Tool Part Number	Replacement End Caps Part Number <sup>2</sup>	Standard Coverstrip Rail Part Number <sup>3</sup>	Coverstrip Width (mm)	Max Single PC Length (mm)
25	531RCS25	531RCT25	531RCP25	521H25C	15	6000
30	531RCS30	531RCT30	531RCP30	521H30C	19	6000
35	531RCS35	531RCT35	531RCP35	521H35C	25	6000
45	531RCS45	531RCT45	531RCP45	521H45C	25	6000

- Customer to specify length of rail to be used on at time of order.  
Delivered piece will be 2 to 3.5 mm longer in order to properly install and fit end caps.
- Two end caps are supplied with each piece of 531RCS ordered.
- H grade accuracy shown for example purposes, P and U grade accuracy are available.
- Cover strip should not be installed more than 3 times.

## Accuracy Class

Three tolerances describe the accuracy of a Profile Rail bearing: Running Parallelism, Pair Variation, and Assembly Accuracy. These are measured from the rail base to the center of the carriage top (H), and from the rail reference edge to the center of the carriage reference edge (A3).

Running Parallelism describes the tolerance on H and A3 as a function of axial travel, measured from one carriage down the length of the rail. This is analogous to straightness of travel. As such, parallelism describes attributes of the rail only.

Assembly Accuracy describes the tolerance on H and A3 as a function of a carriage – rail assembly, measured from the nominal dimensions.

Pair Variation describes tolerance on H and A3 as a function of carriages at the same position on a common rail. Pair variation describes carriage precision only.

The accuracy class selected will partially determine the accuracy of the system. Other factors such as mounting surface flatness and straightness also significantly affect system accuracy.

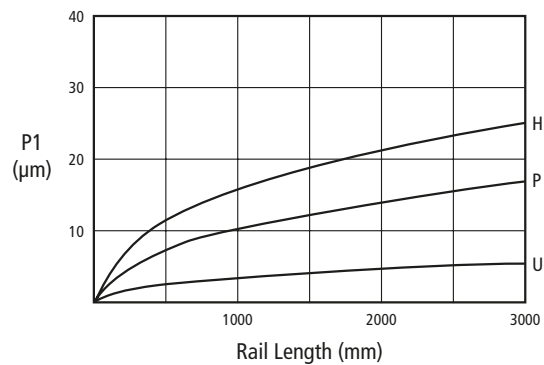
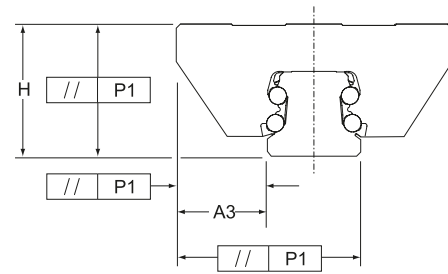

### Tolerances

	Accuracy Class		
	H - High	P - Precision	U - Ultra Precision
Assembly Accuracy Tolerance on dimension H and A3 (measured at middle of carriage at any point along rail)	±50	±20	±5
Pair Variation Max variation in dimensions H and A3 measured on multiple carriages mounted on the same rail (measured at the middle of carriage at same position on rail)	15	7	3
Running Parallelism	100	40	10

All values in µm

## Preload

Three Preload classes and one clearance class are available with the 500 Series Ball Profile Rail carriages. Preload will minimize elastic deformation caused by external forces resulting in increased rigidity. Preload will eliminate internal clearances between the rail and carriage resulting in zero backlash.

### Preload Accuracy Combinations

Accuracy Class	Clearance	Preload		
		0.03C <sup>1</sup>	0.08C <sup>1</sup>	0.13C <sup>1</sup>
H	0	1	2	
P, U		1	2	3

- C = Dynamic load capacity of the bearing
- A preloaded bearing loaded beyond the preload value has the same characteristics as a clearance bearing. Example: Size 25 A style carriage has dynamic load capacity of 21.1kN, Medium Preload = 0.08C = 0.08 x 21.1kN = 1.7kN; if applied load is greater than 1.7kN preload has no benefit.

## 500 Series Roller Profile Rail Linear Guide

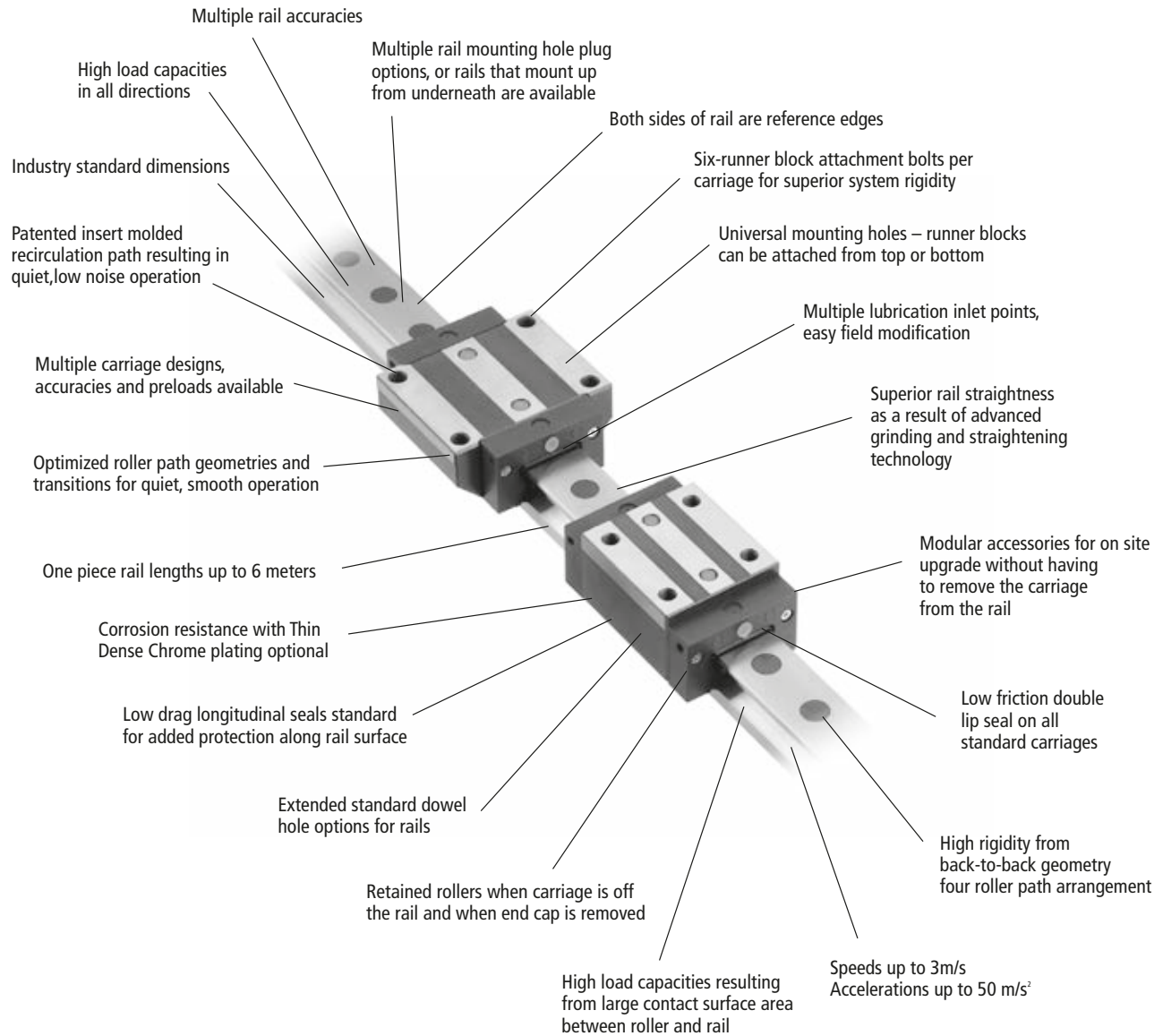

## 500 Series Roller Profile Rail Linear Guide



### Features

The Thomson 500 Series Linear Guide provides long life, exceptional rigidity, high dynamic and static load capacities, accommodation for high moment loads, high running accuracy, multiple sealing options and multiple lubrication inlet options. This allows for on-site field modification, and interchangeability with competitor offering.

These properties result in improved machine accuracies and rigidity resulting in reduced vibration extending machine and tool life. This has a direct effect on your operational efficiency resulting in cost savings for the user.

Available in 4 carriage designs.

### Materials

The 500 Series Roller Linear Guide is produced from high quality bearing steel. The end cap is made of a high strength, glass-filled nylon with a nitrile rubber seal. All carriages and rolling elements are through hardened and all rails are case hardened. Stringent quality controls are in place to ensure consistency of materials from the source, allowing us to ensure that we deliver the highest quality product.

### Interchangeability

The 500 Series Roller Linear Guide is completely interchangeable. Any carriage can be run on any rail of the same accuracy without compromising system accuracy. This is the result of our stringent manufacturing process controls.

### Accuracy and Preload

The 500 Series Roller Linear Guide is available in three different accuracy classes, and three different preload ranges to allow for customization to your application needs.

### Straightness

The 500 Series Roller rail is subjected to multiple straightening processes during and after grinding of the roller paths, on one piece rails up to 6 meters long.

These added processes and inspections result in some of the straightest rails in the market today, improving machine accuracies wherever the 500 Series Roller is used.

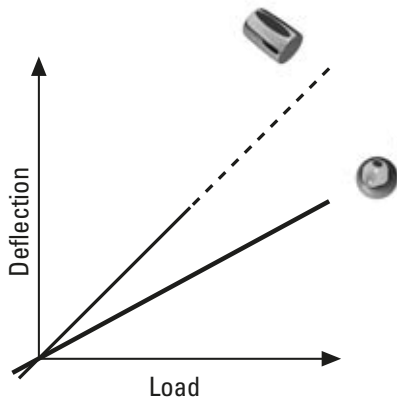

### Rigidity

Profile Rail Linear Guide bearings have a significant effect on the overall system rigidity. The 500 Series Roller rigidity is achieved by using the equivalent of a back-to-back bearing arrangement, complemented by special rollers that are crowned to prevent roller edge loading when misalignment is present. This results in lower elastic deformation as the load increases compared to a ball carriage or face-to-face bearing arrangement.

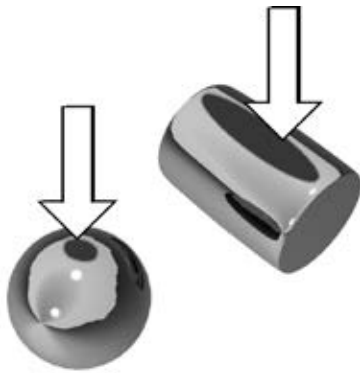

### Load Capacity

The roller has an increased load capacity over the ball as a result of the increased contacting surface across the length of the roller. A ball provides a single point contact area, while a roller provides a much greater line contact area. This results in a substantially higher load carrying capacity and lower wear with minimum rolling friction.



### Running Smoothness / Low Noise

The running smoothness and low noise are the result of a proprietary insert molded recirculation path that has an optimized geometric shape and minimal transitions. This ensures smooth, quiet operation.

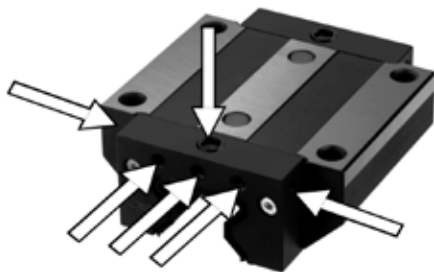

### Multiple Lubrication Options

The carriage standard end cap is designed for flexibility. The end cap is equipped with six lubrication inlet points and additional internal options for directing grease or oil to the proper location. These options are easily changed on-site in the field or can be supplied from the factory. Not all options available on size 25.

Unsure of the best lubrication inlet location? These carriages will allow the user to make these changes easily in the field to optimize the system performance. In addition, they allow for ease in maintenance.



### Modular Accessory Options

The carriage is supplied standard with low friction double lip seals and longitudinal seals that completely enclose the bearing carriage to protect the rollers and track surfaces and minimize lubrication loss.

Optional metal scrapers or wiper and oil reservoir components can be easily added on-site in the field or can be supplied assembled from the factory.

These innovative design features allow users to easily, efficiently, and economically upgrade carriage sealing and lubrication without needing to replace the entire carriage assembly.



### Longitudinal Seals

The carriage has built-in under carriage low drag longitudinal seals that protect the rollers and roller track surfaces from contamination. These longitudinal seals are an added protection to increase the life and overall performance.



### Rail Accessories

The rails have multiple options to fill the mounting holes to eliminate possible contamination entry into the bearing. Custom designed plugs are available in plastic, brass, or stainless steel. A special rail is available that utilizes a custom cover strip. In addition, Thomson stocks an assortment of bellows to protect the entire assembly. All options are available from stock and represent another innovative design feature of the 500 Series. Mounting tools for easy and correct installation are available as well.

### Retained Rollers

The rolling elements of the carriages are retained within the bearing so the carriage can be removed from the rail, or the end cap from the carriage, without worrying about the rollers falling out. It is recommended to place any removed carriage onto a mounting rail or shipping arbor to provide added protection to the rolling elements.

## 500 Series Roller Profile Rail Linear Guide

### Modular Design Exploded View

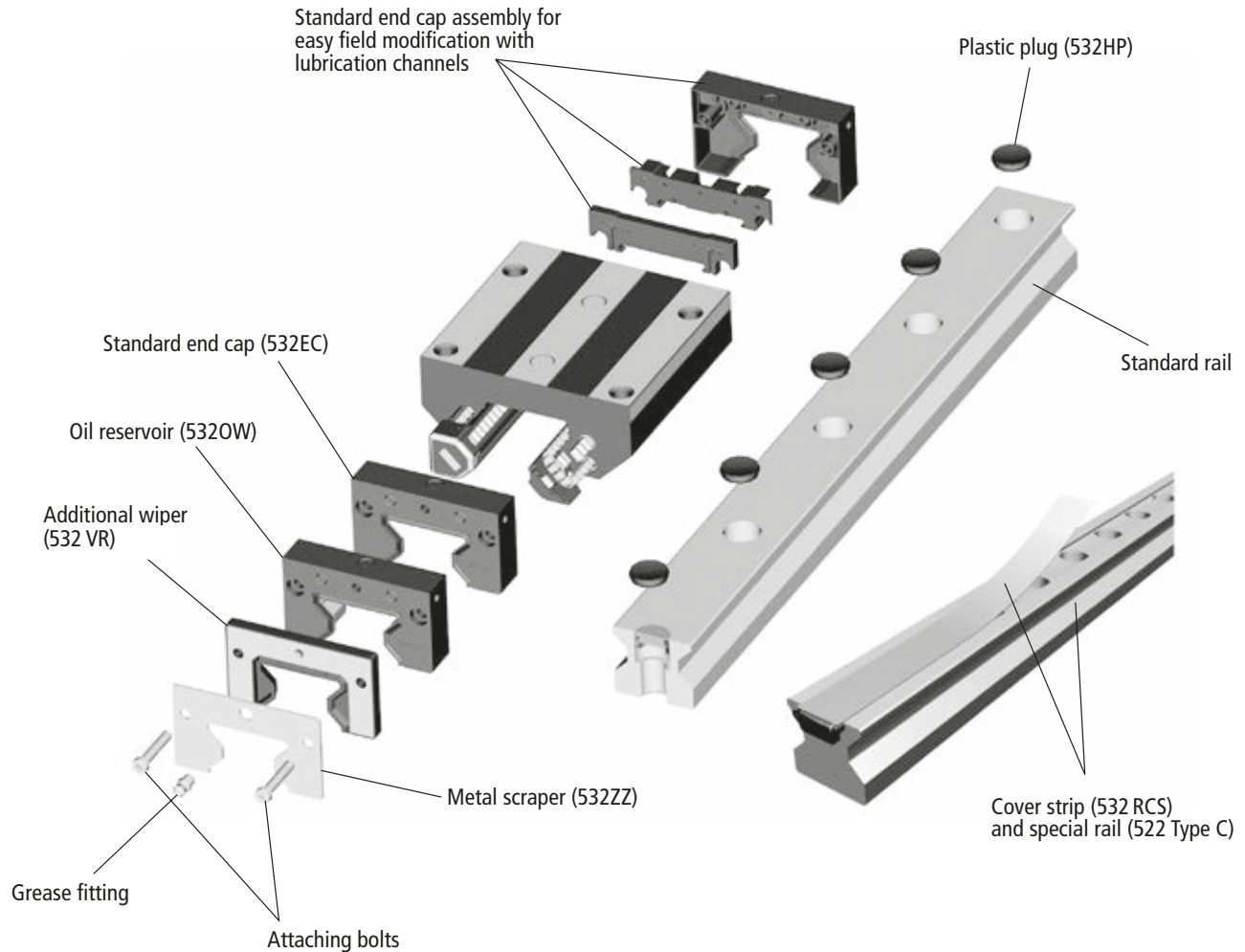

Also available (not shown):

- Stainless Steel Rail Plugs (532 HS)
- Brass Rail Plugs (532 HB)
- Mylar Tape (532 RT)
- Bolt up from bottom rail (522 Type U)

The modular, building block design of the 500 Series Roller Profile Rail Linear Guide assembly for easy on-site field upgrades, for quick seal or lubrication upgrades all without the need for new carriage or rails.



### 500 Series Roller Standard Carriages

Thomson offers four carriage styles with six mounting holes allowing for additional mounting configurations in the field or retrofitting. All provide superior rigidity and design flexibility.

500 Series Roller  
Profile Rail

Style	Size	Accuracy	Basic Part Number			Standard Rail Part Number	Max. Single Piece Rail Length (mm)		
			Preload						
			0.03C	0.08C	0.13C				
Standard Carriage	A	25	P	512P25A1	512P25A2	512P25A3	522P25A	6000	
			S	512S25A1	512S25A2	512S25A3	522S25A		
			U	512U25A1	512U25A2	512U25A3	522U25A		
		35	P	512P35A1	512P35A2	512P35A3	522P35A	6000	
			S	512S35A1	512S35A2	512S35A3	522S35A		
			U	512U35A1	512U35A2	512U35A3	522U35A		
	45	P	512P45A1	512P45A2	512P45A3	522P45A	6000		
		S	512S45A1	512S45A2	512S45A3	522S45A			
		U	512U45A1	512U45A2	512U45A3	522U45A			
	55	P	512P55A1	512P55A2	512P55A3	522P55A	6000		
		S	512S55A1	512S55A2	512S55A3	522S55A			
		U	512U55A1	512U55A2	512U55A3	522U55A			
Standard Long Carriage	B	25	P	512P25B1	512P25B2	512P25B3	522P25A	6000	
			S	512S25B1	512S25B2	512S25B3	522S25A		
			U	512U25B1	512U25B2	512U25B3	522U25A		
		35	P	512P35B1	512P35B2	512P35B3	522P35A	6000	
			S	512S35B1	512S35B2	512S35B3	522S35A		
			U	512U35B1	512U35B2	512U35B3	522U35A		
		45	P	512P45B1	512P45B2	512P45B3	522P45A	6000	
			S	512S45B1	512S45B2	512S45B3	522S45A		
			U	512U45B1	512U45B2	512U45B3	522U45A		
		55	P	512P55B1	512P55B2	512P55B3	522P55A	6000	
			S	512S55B1	512S55B2	512S55B3	522S55A		
			U	512U55B1	512U55B2	512U55B3	522U55A		
	65	P	512P65B1	512P65B2	512P65B3	522P65A	6000		
		S	512S65B1	512S65B2	512S65B3	522S65A			
		U	512U65B1	512U65B2	512U65B3	522U65A			
	Narrow Carriage	C	25	P	512P25C1	512P25C2	512P25C3	522P25A	6000
				S	512S25C1	512S25C2	512S25C3	522S25A	
				U	512U25C1	512U25C2	512U25C3	522U25A	
35			P	512P35C1	512P35C2	512P35C3	522P35A	6000	
			S	512S35C1	512S35C2	512S35C3	522S35A		
			U	512U35C1	512U35C2	512U35C3	522U35A		
45			P	512P45C1	512P45C2	512P45C3	522P45A	6000	
			S	512S45C1	512S45C2	512S45C3	522S45A		
			U	512U45C1	512U45C2	512U45C3	522U45A		
55			P	512P55C1	512P55C2	512P55C3	522P550A	6000	
			S	512S55C1	512S55C2	512S55C3	522S55A		
			U	512U55C1	512U55C2	512U55C3	522U55A		
Narrow Long Carriage	D	25	P	512P25D1	512P25D2	512P25D3	522P25A	6000	
			S	512S25D1	512S25D2	512S25D3	522S25A		
			U	512U25D1	512U25D2	512U25D3	522U25A		
		35	P	512P35D1	512P35D2	512S35D3	522P35A	6000	
			S	512S35D1	512S35D2	512S35D3	522S35A		
			U	512U35D1	512U35D2	512U35D3	522U35A		
		45	P	512P45D1	512P45D2	512P45D3	522P45A	6000	
			S	512S45D1	512S45D2	512S45D3	522S45A		
			U	512U45D1	512U45D2	512U45D3	522U45A		
		55	P	512P55D1	512P55D2	512P55D3	522P55A	6000	
			S	512S55D1	512S55D2	512S55D3	522S55A		
			U	512U55D1	512U55D2	512U55D3	522U55A		
65	P	512P65D1	512P65D2	512P65D3	522P65A	6000			
	S	512S65D1	512S65D2	512S65D3	522S65A				
	U	512U65D1	512U65D2	512U65D3	522U65A				

## 500 Series Roller Rail Options

Bolt down from the top – 522 Type A

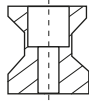

Bolt down from the bottom – 522 Type U

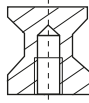

### Rail Types and Accessories

The 500 Series Roller Profile Rail is available in two configurations:

- Bolt Down from the top – 522 Type A
- Bolt Up from the bottom – 522 Type U

The bolt down from the top design has various types of options to plug the holes.

The standard 522 Type A rail mounting holes can be plugged or sealed after installation using the options below.

#### Plastic Plugs

532 HP plastic plugs are an inexpensive and simple method to seal the rail attachment bolt area. The plastic plugs are easy driven in place to any rails with a soft non-metallic drift. They can easily be removed.

#### Brass Plugs

532 HB brass plugs are more rugged than the plastic plug, slightly more expensive, and require more precision during installation. They fit in all stand 500 Series Roller Rails and require some hand buffing or polishing of the rail surface after installation.

#### Two-piece Stainless Steel Plugs

532 HS two-piece stainless plugs are the most rugged plugs available for the roller rails. The two piece construction and design allows the plugs to lock into place and rest on the top of the socket head bolt. They require no post installation polishing. The recommended hex head socket must be used to properly install the 532 HS plugs. For correct installation, we recommend use of the 532 HST mounting tools found on page 67.

#### Mylar Tape

A simple and low cost alternative is specialty Mylar tape that can be placed quickly on the top surface of the rail. Part number 532 RT is available in 3 meter lengths.

#### Optional 500 Series Rail

Option 532 RC utilizes a special rail 522 Type C that is easily installed with the 532 RCT mounting tool found on page 67.

#### Carriage Option

The 500 Series Roller Profile carriages are also available with special lubrications. They can be ordered directly from stock or with a short lead-time.

## 500 Series Roller Profile Rail



### Additional Seal Types and Lubrication Accessories

The carriages are designed with modular sealing and lubrication options for simple on-site field modification or factory direct.

The standard carriage end cap has an integral low friction double lip seal and longitudinal seals that completely enclose the bearing carriage. The double lip design keeps contaminants out and lubrication in. It also allows for grease to purge out of the carriage to prevent excessive lubrication, which can result in higher operating temperatures. This double lip design allows for use with oil lubrication.

This standard carriage end cap comes standard with a lubrication inlet centered in the end cap with specially designed and modified lubrication channels to direct the lubrication to the different roller tracks. The lubrication inlet can be easily changed in the field or supplied from the factory for side inlet, offset inlet or top inlet. Additionally, the internal configuration can be modified to allow for separating the lubrication paths for vertical mounting or oil lubrication.

The standard carriage end cap is equipped with lubrication channels directing lubrication to proper roller paths. The standard carriage end plate can be easily modified on-site in the field to channel lubrication separately or can be factory ordered.

### Optional – on site field installable modular seals and accessories

#### Additional Seal

The **532 VR** seal provide an additional level of protection from contaminants to the assembly. This additional component can be easily added on-site. It is supplied with the required screws to make installation simple.

- 532 VR is made of durable Viton®

This seal can be used in conjunction with other optional modular accessories providing an easy upgrade to the standard seal. It can be easily installed on-site in the field or can be supplied from the factory.

#### Metal Scraper

The **532 ZZ Metal Scraper** made of stainless steel, serves as an added protection to the seal lips against large dirt particles, metal shavings or chips. Large contaminants are easily pushed away for an extra level of protection to the seal lips. The Metal Scraper is easily installed in conjunction with other optional modular accessories providing you with an easy upgrade to the standard seal. These are easily installed on-site in the field or can be supplied from the factory.



### Oil Reservoir

The **532 OW Oil Reservoir** is a cost effective, automatic lubrication system. It is constructed with an integrated oil reservoir that provides a uniform, consistent lubricating oil to the roller paths for extended periods of time. The Type 532 OW oil reservoir eliminates the need for a routine maintenance schedule, assures lubrication gets to the required points, can be refilled if required, and can operate up to 5000 km of travel.

The Type 532 OW oil reservoir can be easily installed in conjunction with other optional modular seals for an easy upgrade to the standard seal. These can be easily installed on-site in the field or can be supplied from the factory.

### Bellows

**Standard bellows** are available for all assemblies. The bellows cover the entire length of the rail. The bellows are used to provide additional protection against dirt, dust and splashed liquid. Installation is simple and requires little time. Retrofitting is possible when the rail ends are drilled for the attachment of the rail clip 532 CR.

Bellows are available in three styles:

- Type B “Low Profile” with outside dimensions that do not exceed the carriage
- Type C “High Compression”
- Type W “Walk-On” capable of handling the harshest environments with a 90 kg load bearing capacity

The bellows can be easily installed in conjunction with the other optional modular accessories and are an easy upgrade to the standard seal. These can be easily installed on-site in the field.

Note: Additional Modular accessories add additional drag to the carriage assembly resulting in increased start-up friction and power consumption.

### Relative Drag Comparison for Design Consideration

Type	Relative Drag
Standard carriage	•
Viton® Wiper (531 VR)	• • •
Metal Scraper (531 ZZ)	•
Oil Reservoir (531 OW)	• •

• Low

**For ordering information or for additional Seal Types and Lubrication Accessories, see page 62.**

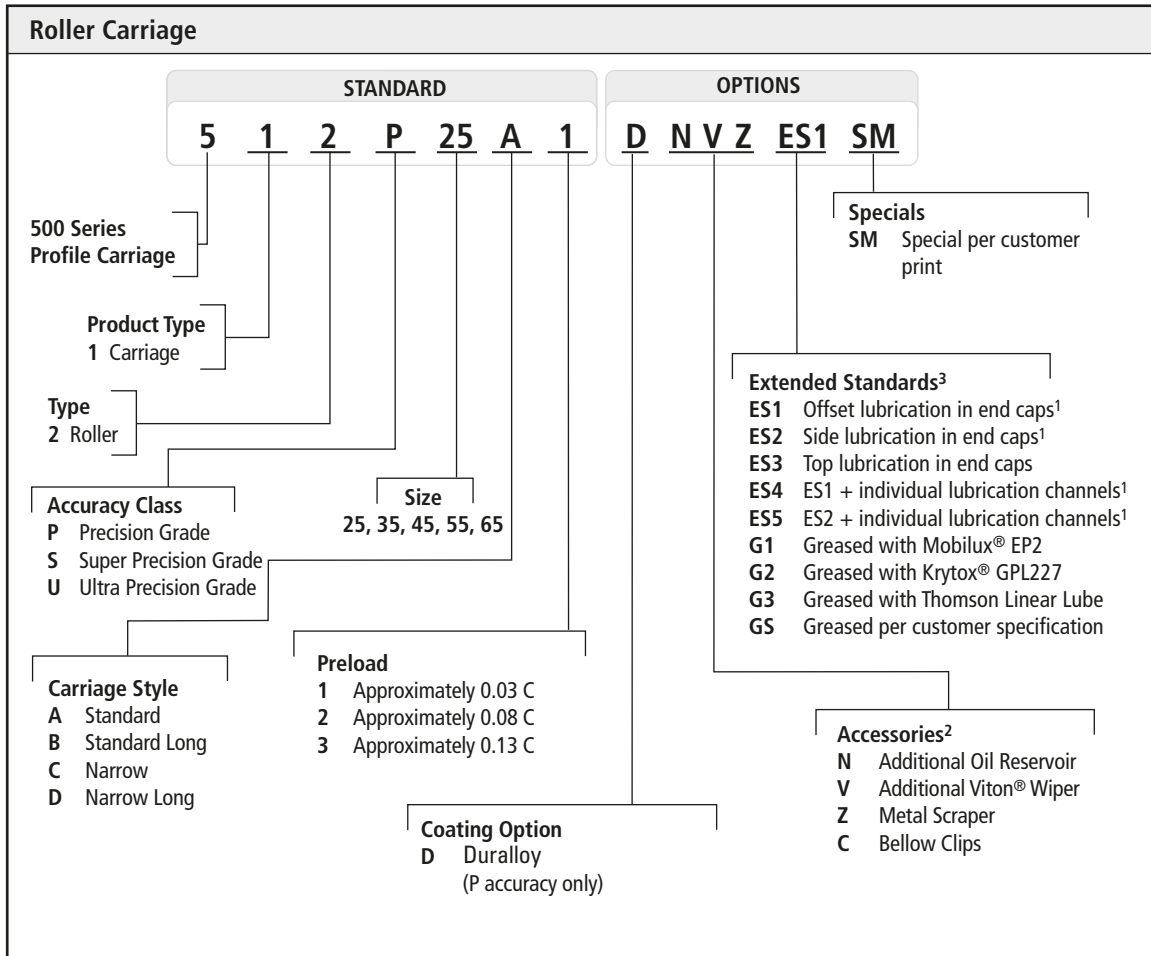

1. ES1, ES2, ES4 and ES5 options are available size 35, 45, 55 and 65 only.  
 2. Accessory combination part numbers are listed from carriage end cap outward. Not all combinations are available. For specific combination availability see page 64 or consult Thomson.

3. Optional inlet and grease options may not be functional with all accessory combinations. (Example: G1 and Oil Reservoir "N"). Prior to selecting an inlet option review any interference or conflicts with the accessories selected.

4. Size 100 available upon request. Please contact customer service for more information.

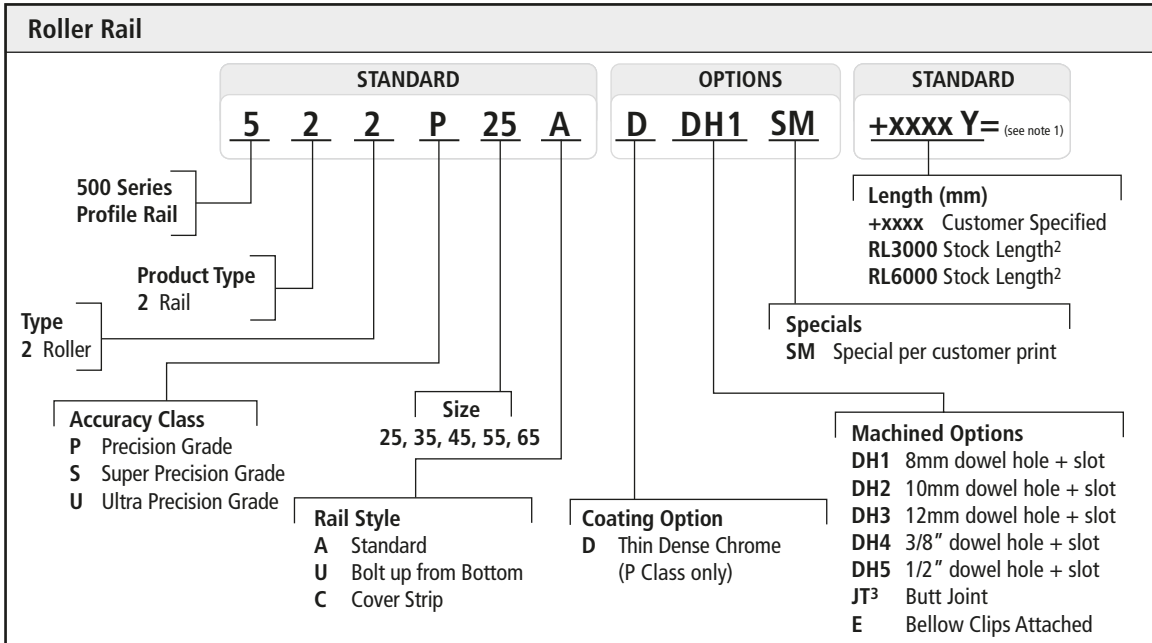

1. Y=Distance from end of rail to center of first mounting hole, Y1=Y2 unless specified.
2. Stock length rails are considered random length, total length may exceed specified length, and Y1/Y2 are not equal. To be used by customer who will cut to length.
3. Customer drawing required at time of quote and order.

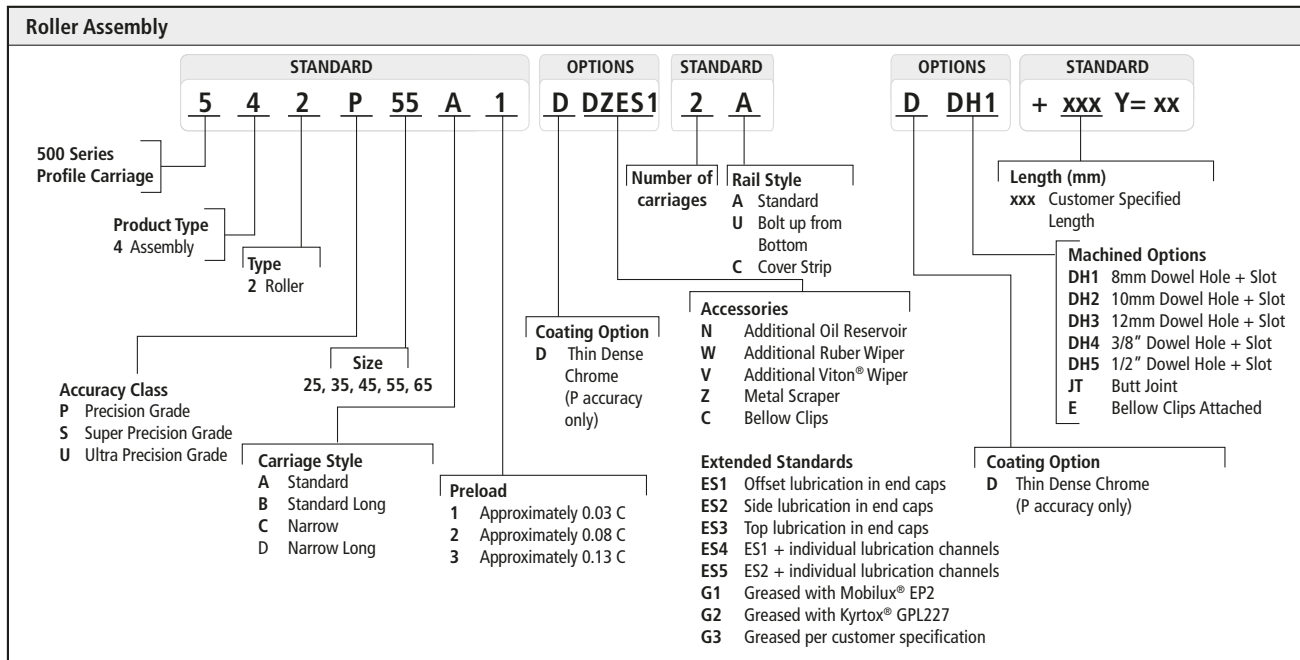

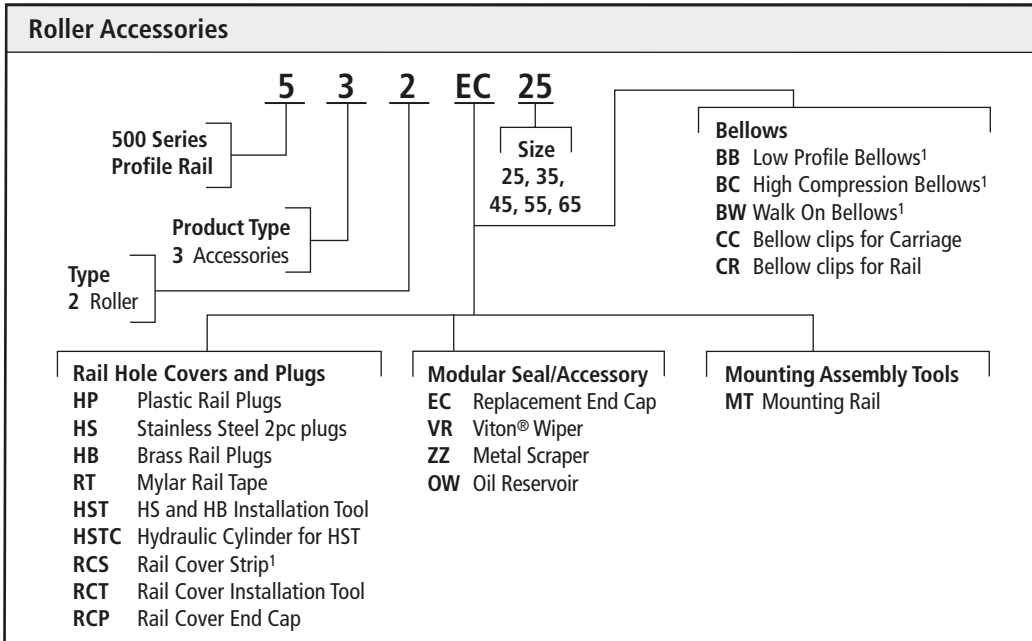

1. Bellows and rail cover strip must include length at time of order.  
(Example: 532BB35+1000 mm). See page 148 for how to calculate bellows length.

## 500 Series Roller

### 512 Style A and B

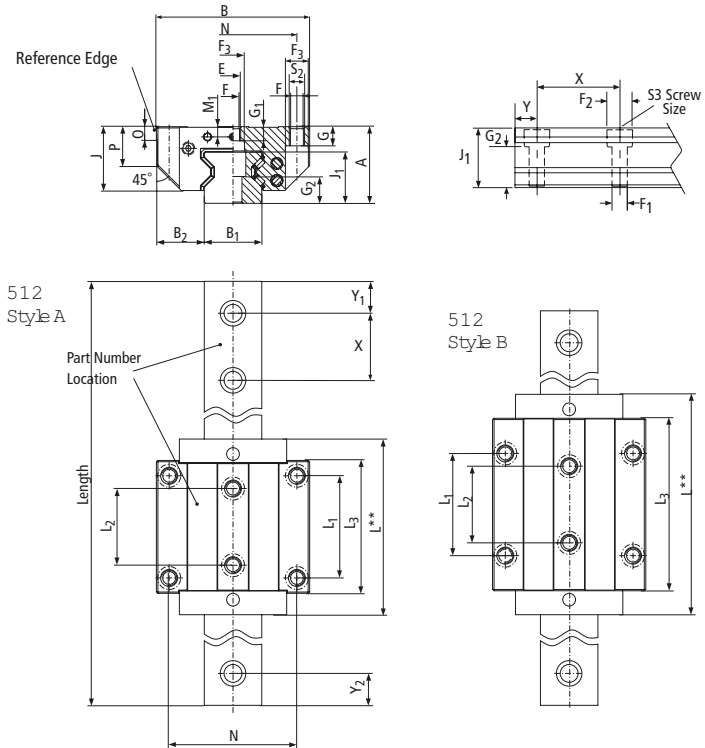
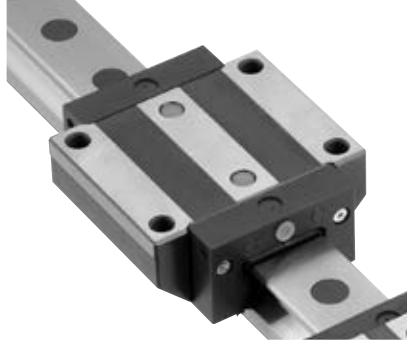

### 512 Style A – Standard Roller

Size	Dimensions (mm)											Roller													
	A	B	B <sub>1</sub> * ±0.05	B <sub>2</sub>	J	J <sub>1</sub>	L**	L <sub>1</sub>	L <sub>2</sub>	L <sub>3</sub>	X	N	S <sub>2</sub>	S <sub>3</sub>	F	F <sub>1</sub>	F <sub>2</sub>	F <sub>3</sub>	Ø	G	G <sub>1</sub>	G <sub>2</sub>	M <sub>1</sub>	O	P
25	36	70	23	23.5	29.5	24.5	81	45	40	60	30	57	M8	M6	6.8	7	11	11	3.2	9	6.5	13	5.5	7.5	17.5
35	48	100	34	33	40	32	109	62	52	80	40	82	M10	M8	8.5	9	15	15	4.5	12	10	15	7	8	23
45	60	120	45	37.5	50	40	137.5	80	60	104	52.5	100	M12	M12	10.5	14	20	18	5	15	11	21	8	10	30.5
55	70	140	53	43.5	57	48	163.5	95	70	120	60	116	M14	M14	12.5	16	24	20	6	18	13.5	26	9	12	34.5

### 512 Style B – Standard Long Roller

Size	Dimensions (mm)											Roller													
	A	B	B <sub>1</sub> * ±0.05	B <sub>2</sub>	J	J <sub>1</sub>	L**	L <sub>1</sub>	L <sub>2</sub>	L <sub>3</sub>	X	N	S <sub>2</sub>	S <sub>3</sub>	F	F <sub>1</sub>	F <sub>2</sub>	F <sub>3</sub>	Ø	G	G <sub>1</sub>	G <sub>2</sub>	M <sub>1</sub>	O	P
25	36	70	23	23.5	29.5	24.5	103.4	45	40	79.4	30	57	M8	M6	6.8	7	11	11	3.2	9	6.5	13	5.5	7.5	17.5
35	48	100	34	33	40	32	136	62	52	103	40	82	M10	M8	8.5	9	15	15	4.5	12	10	15	7	8	23
45	60	120	45	37.5	50	40	172.5	80	60	135	52.5	100	M12	M12	10.5	14	20	18	5	15	11	21	8	10	30.5
55	70	140	53	43.5	57	48	205.5	95	70	162	60	116	M14	M14	12.5	16	24	20	6	18	13.5	26	9	12	34.5
65	90	170	63	53.5	76	58	251	110	82	201	75	142	M16	M16	14.5	18	26	25.5	7	23	19	32	13	15	51

\* Standard tolerance shown, special lower tolerances are available upon request. Please consult application engineering for additional information.

\*\*When using additional modular seals or lubrication plates, the total length L will increase. Consult page 62-63 for additional information.

Length of rail to be specified at time of order,  $Y_1 = Y_2$  unless specified otherwise at time of order.



# 500 Series Roller

## 512 Style A and B

### Dynamic Load and Moment Ratings

C = Dynamic load rating  
 M<sub>L</sub> = Dynamic pitch and yaw moment rating  
 M<sub>Q</sub> = Dynamic roll moment rating

### Static Load and Moment Capacities

C<sub>0</sub> = Static load capacity  
 M<sub>0L</sub> = Static pitch and yaw moment capacity  
 M<sub>0</sub> = Static roll moment capacity

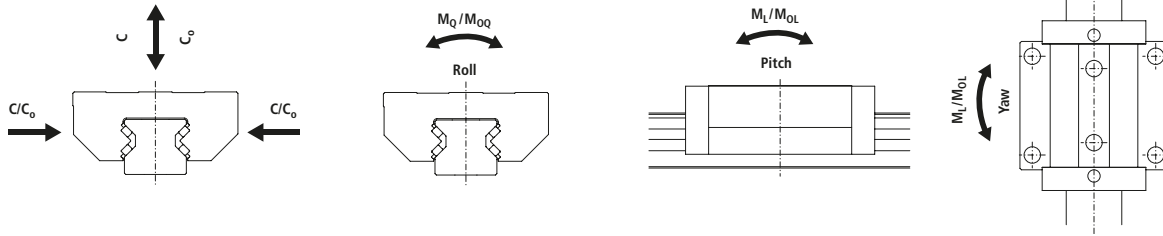

Size & Style	Loading Capabilities		Moments				Weights	
	C <sub>0</sub> (N)	C (N)	M <sub>0Q</sub> (Nm)	M <sub>0</sub> (Nm)	M <sub>0L</sub> (Nm)	M <sub>L</sub> (Nm)	Carriage (kg)	Rail (kg/m)
25A	49800	27700	733	408	476	265	0.7	
25B	70300	39100	1035	576	936	521	0.9	3.4
35A	93400	52000	2008	1118	1189	662	1.6	
35B	128500	71500	2762	1537	2214	1232	2.2	6.5
45A	167500	93400	4621	2577	2790	1556	3.2	
45B	229500	127800	6333	3527	5161	2874	4.3	10.7
55A	237000	131900	7771	4325	6650	2637	5.0	
55B	324000	180500	10624	5919	8745	4872	6.8	15.2
65B	530000	295000	20912	11640	17930	9980	13.5	22.5

- The dynamic load and moment ratings are based upon 100 km travel life. When comparing these load ratings with other bearings take into consideration that some manufacturers dynamic and moment ratings are based on 50 km travel life. In order to compare with bearing dynamic and moment ratings based on 50 km travel life, divide the dynamic capacity of the bearing rated for 50 km by 1.23 to get an accurate comparison.
- The static load and moment rating are the maximum radial load and moment load that should be applied to the bearing while there is no relative motion between the carriage and rail.

### Bearing Travel Life Comparison

$$L = (C/F)^3 \times 100\text{km}$$

where:

L = travel life, km

C = dynamic load rating, N

F = applied dynamic load, N

$$C_{\min} = F \left( \frac{L}{100} \right)^{1/3}$$

where:

C<sub>min</sub> = minimum required

dynamic load rating, N

F = applied dynamic load, N

L = required travel life, km

### Operating Parameters:

Maximum Velocity: 3 m/s

Maximum Acceleration: 50 m/s<sup>2</sup>

Temperature: Min: -40° C

Max: 80° C

Max peak: 120° C short time\*

\*without bellows

## 500 Series Roller

### 512 Style C and D

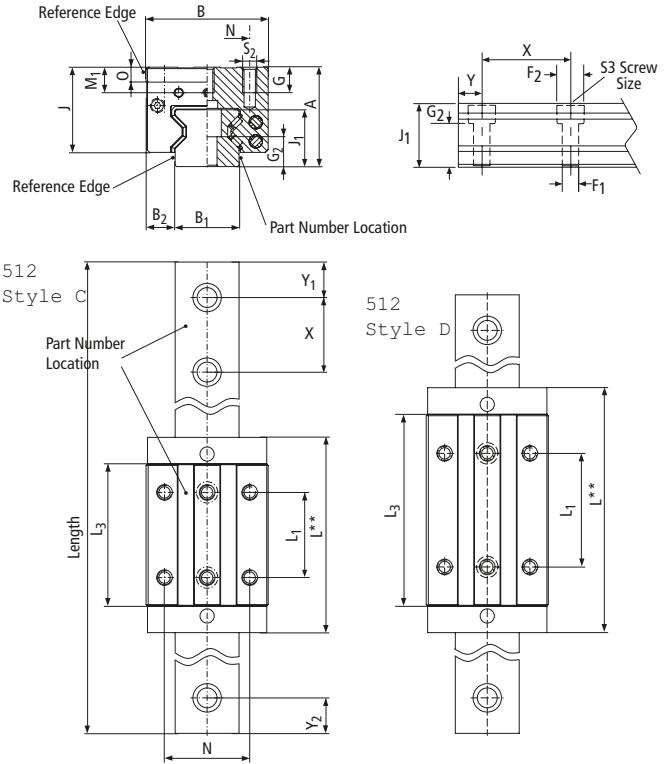
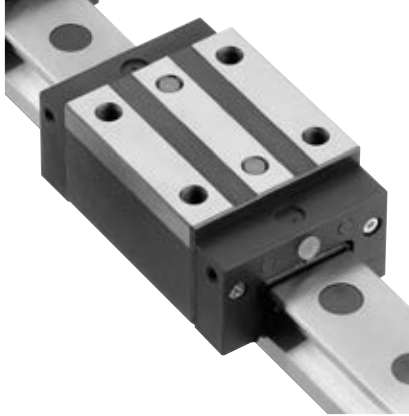

### 512 Style C Narrow Roller

Size	Dimensions (mm)						L**	L <sub>1</sub>	L <sub>3</sub>	X	N	S <sub>2</sub>	S <sub>3</sub>	F <sub>1</sub>	F <sub>2</sub>	Roller				
	A	B	B <sub>1</sub> * +0.05	B <sub>2</sub>	J	J <sub>1</sub>										Ø	G	G <sub>2</sub>	M <sub>1</sub>	O
25	40	48	23	12.5	33.5	24.5	81	35	57	30	35	M6	M6	7	11	3.2	9	13	9.5	7.5
35	55	70	34	18	47	32	109	50	76	40	50	M8	M8	9	15	4.5	12	15	14	8
45	70	86	45	20.5	60	40	137.5	60	100	52.5	60	M10	M12	14	20	5	18	21	18	10
55	80	100	53	23.5	67	48	163.5	75	120	60	75	M12	M14	16	24	6	19	26	19	12

### 512 Style D Narrow Long Roller

Size	Dimensions (mm)						L**	L <sub>1</sub>	L <sub>3</sub>	X	N	S <sub>2</sub>	S <sub>3</sub>	F <sub>1</sub>	F <sub>2</sub>	Roller				
	A	B	B <sub>1</sub> * +0.05	B <sub>2</sub>	J	J <sub>1</sub>										Ø	G	G <sub>2</sub>	M <sub>1</sub>	O
25	40	48	23	12.5	33.5	24.5	103.4	50	79.4	30	35	M6	M6	7	11	3.2	9	13	9.5	7.5
35	55	70	34	18	47	32	136	72	103	40	50	M8	M8	9	15	4.5	12	15	14	8
45	70	86	45	20.5	60	40	172.5	80	135	52.5	60	M10	M12	14	20	5	18	21	18	10
55	80	100	53	23.5	67	48	205.5	95	162	60	75	M12	M14	16	24	6	19	26	19	12
65	90	126	63	31.5	76	58	251	120	201	75	76	M16	M16	18	26	7	20	32	13	15

\* Standard tolerance shown, special lower tolerances are available upon request. Please consult application engineering for additional information.

\*\* When using additional modular seals or lubrication plates, the total length L will increase. Consult page 62-63 for additional information.

Length of rail to be specified at time of order, Y<sub>1</sub>=Y<sub>2</sub> unless specified otherwise at time of order.

## 500 Series Roller

### 512 Style C and D

#### Dynamic Load and Moment Ratings

C = Dynamic load rating  
 M<sub>L</sub> = Dynamic pitch and yaw moment rating  
 M<sub>Q</sub> = Dynamic roll moment rating

#### Static Load and Moment Capacities

C<sub>0</sub> = Static load capacity  
 M<sub>OL</sub> = Static pitch and yaw moment capacity  
 M<sub>OQ</sub> = Static roll moment capacity

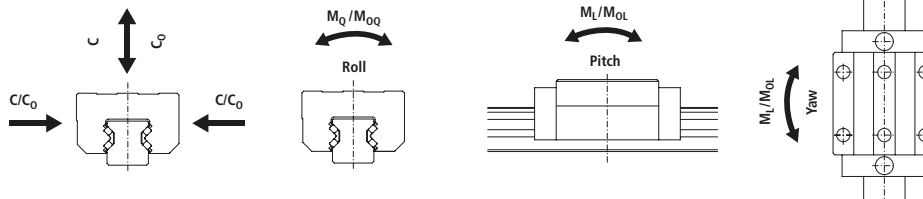

500 Series Roller  
Profile Rail

Size & Style	Loading Capabilities		Moments				Weights	
	C <sub>0</sub> (N)	C (N)	M <sub>OQ</sub> (Nm)	M <sub>Q</sub> (Nm)	M <sub>OL</sub> (Nm)	M <sub>L</sub> (Nm)	Carriage (kg)	Rail (kg/m)
25C	49800	27700	733	408	476	265	0.6	
25D	70300	39100	1035	576	936	521	0.7	3.4
35C	93400	52000	2008	1118	1189	662	1.5	
35D	128500	71500	2762	1537	2214	1232	2.0	6.5
45C	167500	93400	4621	2577	2790	1556	3.0	
45D	229500	127800	6333	3527	5161	2874	4.0	10.7
55C	237000	131900	7771	4325	4738	2637	4.5	
55D	324000	180500	10624	5919	8745	4872	6.1	15.2
65D	530000	295000	20912	11640	17930	9980	10.4	22.5

- The dynamic load and moment ratings are based upon 100 km travel life. When comparing these load ratings with other bearings take into consideration some manufacturers dynamic and moment ratings are based on 50 km travel life. In order to compare with bearing dynamic and moment ratings based on 50 km travel life, divide the dynamic capacity of the bearing rated for 50 km by 1.23 to get an accurate comparison.
- The static load and moment rating are the maximum radial load and moment load that should be applied to the bearing while there is no relative motion between the carriage and rail.

### Bearing Travel Life Comparison

$$L = (C/F)^3 \times 100\text{km}$$

where:

L = travel life, km

C = dynamic load rating, N

F = applied dynamic load, N

$$C_{\min} = F \left( \frac{L}{100} \right)^{1/3}$$

where:

C<sub>min</sub> = minimum required dynamic load rating, N

F = applied dynamic load, N

L = required travel life, km

#### Operating Parameters:

Maximum Velocity: 3 m/s

Maximum Acceleration: 50 m/s<sup>2</sup>

Temperature: Min: -40° C

Max: 80° C

Max peak: 120° C short time\*

\*without bellows

## Rail Modifications

The rails can be supplied with dowel holes, radial holes and coaxial holes. Please provide a drawing of your requirement and our Application Engineering Team can provide a quote.

### Maximum Length of Single Piece Rail

Size (mm)	25	35	45	55	65
Maximum Length	6000 mm				

## Extended Standard Rail Options

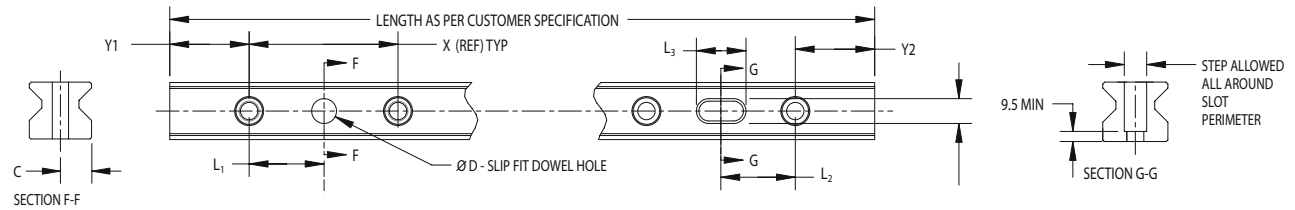

Option	Size	D <small>+0.13 -0</small>	L <sub>1</sub> <small>±0.12</small>	L <sub>2</sub> <small>±0.40</small>	L <sub>3</sub> <small>+1.5 -0</small>	C <small>±0.05</small>
DH1	25	8	15	15	12	11.5
	35		20	20		17
	45		30	30		22.5
	55					26.5
	65					31.5
DH2	25	N/A	N/A	N/A	N/A	N/A
	35	10	20	20	15	17
	45		30	30		22.5
	55					26.5
	65					31.5
DH3	25		N/A	N/A		N/A
	35	12	30	30	18	22.5
	45					26.5
	55					31.5
	65					
DH4	25	N/A	N/A	N/A	N/A	N/A
	35	3/8"	.787"	.787"	.550"	.669"
	45		1.181"	1.181"		.886"
	55					1.043"
	65					1.240"
DH5	25		N/A	N/A		N/A
	35	1/2"	1.181"	1.181"	.750"	.886"
	45					1.043"
	55					
	65					1.240"

All dimensions in mm unless otherwise specified.

Y1 = Y2 unless otherwise specified.

## 522 Type U Rail Bolt Up From Bottom

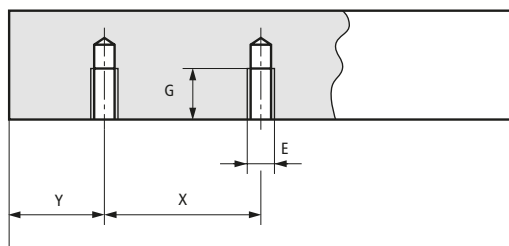

Size	X	E	G (mm)	Weight (kg/in)
25	30	M6	12	3.4
35	40	M8	15	6.5
45	52.5	M12	19	10.7
55	60	M14	22	15.2
65	75	M16	25	22.5

Y1 = Y2 unless specified at time of ordering.

### Lubrication Inlet Options

The standard carriage is supplied with a straight lubrication fitting centered. The carriage end cap has multiple lubrication inlet points and lubrication channels options and is supplied standard with the end cap center inlet plugged. These options can be easily modified on-site in the field or can be supplied factory direct. (Not available for size 25.)

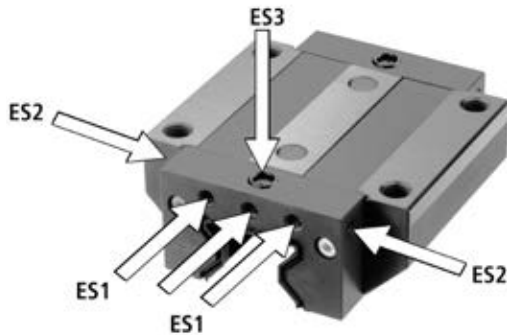

Option	Inlet	Lubrication Channel
ES 1 <sup>2</sup>	Inlets offset - both sides - all four	Standard channel
ES 2	Inlets on side - both sides - all four	Standard channel
ES 3 <sup>1</sup>	Inlet on top	Standard channel
ES 4 <sup>2</sup>	Inlets offset - both sides - all four	Individually channeled path
ES 5	Inlets offset - both sides - all four	Individually channeled path

1. An O-Ring or adapter is required to properly seal the mating surfaces to prevent grease or oil from escaping. One is supplied with this option. The adapter is for C and D style carriages. Lubrication options available in size 35, 45, 55 and 65 only.
2. Option can not be used in combination with additional modular accessories.
3. Set screw is installed in Standard inlet hole when ES2 and ES3 options are specified.
4. Inlets on side and top are solid plugs. When modified on-site, inlets must be punctured to be utilized.

#### Lubrication inlet locations. Front of end cap above rail and slide.

Size	Style	M <sub>1</sub>	M <sub>2</sub>	M <sub>4</sub>	M <sub>3</sub>	D <sub>1</sub>	D <sub>2</sub>
25	A	5.5	N/A	N/A	N/A	M6	N/A
	B						
	C						
	D	9.5					
35	A	7	32	6.5	7	M6	M6
	B						
	C	14					
	D						
45	A	8	40	7.5	8	M6	M6
	B						
	C	18					
	D						
55	A	9	50	8.5	9	M6	M6
	B						
	C	19					
	D						
65	B	13	64	12.5	13	M6	M6
	D						

All dimensions in mm.

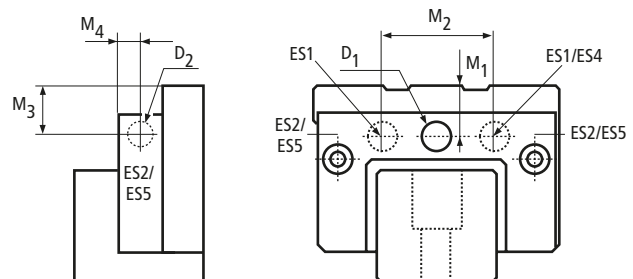

1. D1 and D2 are threaded holes in the end cap to ensure proper integrity and durability of connection.
2. Carriages are shipped with a grease fitting in the box (fitting 530LN). See page 68 for more information.

## Lubricant Inlet Options, cont'd

### Lubrication inlet locations. Inlet on top. "ES3"

Size	Style	C7	D1	D2	D3	D4	Adapter <sup>1</sup>
25	A	12.0	6.75	10	1.78	6	N/A
	B	23.2					
	C	17.0					532ES3ADP25
	D	20.7					
35	A	14.0	6.75	10	1.78	6	N/A
	B	27.5					
	C	20.0					532ES3ADP35
	D	22.5					
45	A	17.0	6.75	10	1.78	6	N/A
	B	34.5					
	C	27.0					532ES3ADP45/55
	D	34.5					
55	A	21.5	6.75	10	1.78	6	N/A
	B	42.5					
	C	31.5					532ES3ADP45/55
	D	42.5					
65	B	54.0	6.5	10	2	6	N/A
	D	49.0					

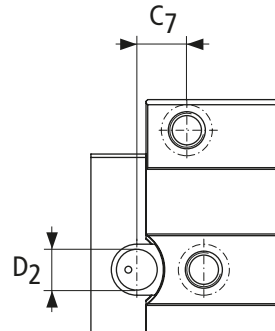

- D1** = O-Ring internal diameter
- D2** = Counterbore diameter
- D3** = O-Ring thickness
- D4** = Max. diameter of lubrication inlet diameter from above

All dimensions in mm.

1. Adapter supplied when ordering ES3 option.

## Grease Lubricants

Standard carriages are sold with oil preservative to protect the rollers from corrosion during storage and transit. The carriages are available with the following assortment of lubricants as standard.

Option	Type	Notes	Viscosity	Temperature Range
G1	Mobilux <sup>®</sup> EP2	All purpose NLGI 2 grease	160cSt @40°C	-20°C to 130°C
G2	Krytox <sup>®</sup> GPL227	High Temperature NLGI 2	440cSt @40°C	-30°C to 288°C
G3	Thomson LinearLube	Food Grade NLGI2 grease	350cSt @40°C	-54°C to 230°C
GS	Customer specified grease			

Additional greases may be available upon request. Please consult Thomson Application Engineering.

## Thin Dense Chrome Plating

Rails and carriages are available with Thin Dense Chrome Plating with a thickness of 2-4  $\mu\text{m}$ . As a result of the plating thickness range compared to the tolerance ranges in the different accuracy classes, it is only available with Precision accuracy classes up to 3 meters long as a single rail; long lengths can be butt jointed.

### Carriage Assortment with Thin Dense Chrome

Type	Style	Size	Accuracy	Preload			Appropriate Standard Rail	Max One Piece Rail Length (mm)
				0.03C	0.08C	0.13C		
512	A	25	P	512P25A1D	512P25A2D	512P25A3D	522P25AD	3000
		35	P	512P35A1D	512P35A2D	512P35A3D	522P35AD	3000
		45	P	512P45A1D	512P45A2D	512P45A3D	522P45AD	3000
		55	P	512P55A1D	512P55A2D	512P55A3D	522P55AD	3000
	B	25	P	512P25B1D	512P25B2D	512P25B3D	522P25AD	3000
		35	P	512P35B1D	512P35B2D	512P35B3D	522P35AD	3000
		45	P	512P45B1D	512P45B2D	512P45B3D	522P45AD	3000
		55	P	512P55B1D	512P55B2D	512P55B3D	522P55AD	3000
		65	P	512P65B1D	512P65B2D	512P65B3D	522P65AD	3000
	C	25	P	512P25C1D	512P25C2D	512P25C3D	522P25AD	3000
		35	P	512P35C1D	512P35C2D	512P35C3D	522P35AD	3000
		45	P	512P45C1D	512P45C2D	512P45C3D	522P45AD	3000
		55	P	512P55C1D	512P55C2D	512P55C3D	522P55AD	3000
	D	25	P	512P25D1D	512P25D2D	512P25D3D	522P25AD	3000
		35	P	512P35D1D	512P35D2D	512P35D3D	522P35AD	3000
		45	P	512P45D1D	512P45D2D	512P45D3D	522P45AD	3000
		55	P	512P55D1D	512P55D2D	512P55D3D	522P55AD	3000
		65	P	512P65D1D	512P65D2D	512P65D3D	522P65AD	3000

Note: Chrome plated carriages and rails are designed and manufactured to be used together. If a non-chrome plated carriage is used on a chrome plated rail the preload of the carriage will be increased approximately one class.

If a chrome plated carriage is used on a non-chrome plated rail the preload will be decreased approximately one class. This is the result of the coating thickness.

## Modular Accessory Combination Options and Screw Size

Option	Description	Size				
		25	35	45	55	65
N <sup>3</sup>	Oil Reservoir	Low/socket head screw M4x30	Low/socket head screw M4x35	Low/socket head screw M5x45	Low/socket head screw M6x45	Low/socket head screw M6x55
V <sup>3</sup>	Viton Wiper	Low/socket head screw M4x25	Low/socket head screw M4x30	Low/socket head screw M5x35	Low/socket head screw M6x35	Low/socket head screw M6x40
Z <sup>3</sup>	Metal Scraper	Low/socket head screw M4x20	Low/socket head screw M4x25	Low/socket head screw M5x30	Low/socket head screw M6x35	Low/socket head screw M6x35
C <sup>3</sup>	Bellows Clips	Flat/socket head screw M4x20	Flat/socket head screw M4x25	Flat/socket head screw M5x25	Flat/socket head screw M6x30	Flat/socket head screw M6x35
NV	Oil Reservoir + Wiper	Low/socket head screw M4x40	Low/socket head screw M4x45	Low/socket head screw M5x50	Low/socket head screw M6x55	Low/socket head screw M6x65
NVZ	Oil Reservoir, Wiper + Scraper	Low/socket head screw M4x40	Low/socket head screw M4x45	Low/socket head screw M5x55	Low/socket head screw M6x60	Low/socket head screw M6x65
NVC	Oil Reservoir, Wiper + Bellows Clip	Flat/socket head screw M4x40	Flat/socket head screw M4x45	Flat/socket head screw M5x50	Flat/socket head screw M6x55	Flat/socket head screw M6x65
NVZC	Oil Reservoir, Wiper, Scraper + Bellows Clip	Flat/socket head screw M4x40	Flat/socket head screw M4x50	Flat/socket head screw M5x55	Flat/socket head screw M6x60	Flat/socket head screw M6x65
NZ	Oil Reservoir + Scraper	Low/socket head screw M4x35	Low/socket head screw M4x40	Low/socket head screw M5x50	Low/socket head screw M6x55	Low/socket head screw M6x60
NZC	Oil Reservoir, Scraper + Bellows Clips	Flat/socket head screw M4x35	Flat/socket head screw M4x40	Flat/socket head screw M5x50	Flat/socket head screw M6x55	Flat/socket head screw M6x60
NC	Oil Reservoir + Bellows Clips	Flat/socket head screw M4x35	Flat/socket head screw M4x40	Flat/socket head screw M5x50	Flat/socket head screw M6x55	Flat/socket head screw M6x60
VC	Wiper + Bellows Clip	Flat/socket head screw M4x25	Flat/socket head screw M4x30	Flat/socket head screw M5x30	Flat/socket head screw M6x35	Flat/socket head screw M6x40
VZ	Wiper + Scraper	Low/socket head screw M4x25	Low/socket head screw M4x30	Low/socket head screw M5x35	Low/socket head screw M6x35	Low/socket head screw M6x40
VZ	Viton Wiper + Scraper	Low/socket head screw M4x25	Low/socket head screw M4x30	Low/socket head screw M5x35	Low/socket head screw M6x35	Low/socket head screw M6x40
ZC	Scraper + Bellows Clip	Flat/socket head screw M4x20	Flat/socket head screw M4x25	Flat/socket head screw M5x25	Flat/socket head screw M6x30	Flat/socket head screw M6x35

1. All fasteners standard thread.
2. Consult Thomson for options not listed, engineering review is required.
3. Each modular accessory is supplied with proper screws to install over end cap only and not combinations of modular accessories.



Modular Seals and Lubrication Accessories

500 Series Roller  
Profile Rail



Additional Wipers  
532VR – Viton® Wiper

Size	Viton® Part Number	L1 (mm)	L2 (mm)	Weight (kg)
25	532VR25	7	4	0.005
35	532VR35	7	4	0.012
45	532VR45	7	4	0.024
55	532VR55	7	4	0.029
65	532VR65	7	4	0.040

L1 – wiper thickness, L2 – max. screw head stickout

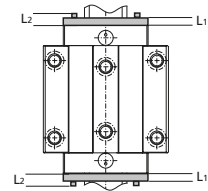

Metal Scraper  
532 ZZ

Size	Part Number	L1 (mm)	L2 (mm)	Weight (kg)
25	532ZZ25	1.5	4	0.011
35	532ZZ35	1.5	4	0.022
45	532ZZ45	1.5	4	0.034
55	532ZZ55	1.5	4	0.044
65	532ZZ65	1.5	4	0.078

L1 = scraper thickness, L2 = max. screw head stickout

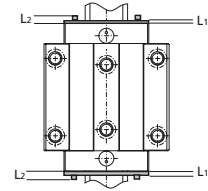

Oil Reservoir  
532 OW

Size	Lubrication Plate	L1 (mm)	Weight (kg)
25	532OW25	12.7	0.013
35	532OW35	16.7	0.032
45	532OW45	19	0.056
55	532OW55	22	0.103
65	532OW65	25.2	0.179

L1 = lubrication plate thickness, screw heads are recessed in plate

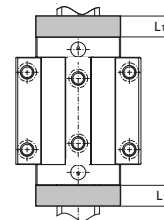

When using a combination of different plates, add the cumulative thickness of the plates to get an accurate overall carriage length.

**Example:**

**512 Size 45 carriage with 532 OW and 532 VR modular seals on both sides:**

Carriage Length (L)	= 137.5
532 OW L1 x 2	= 19 x 2
532 VR L1 x 2	= 7 x 2
532 VR L2 x 2	= 4 x 2
<b>Total Length</b>	<b>= 193.5 mm</b>

**511 Size 35 carriage with 531OW modular seal on both sides and 531VR modular seals on one side:**

Carriage Length (L)	= 109
532 OW L1 x 2	= 16.7 x 2
532 VR L1 x 1	= 7 x 1
532 VR L2 x 1	= 4 x 1
<b>Total Length</b>	<b>= 153.4 mm</b>

Each modular accessory is supplied with the proper screws to install them over the end cap. When combinations of modular seals are used longer screws may be required. The following sizes are available from our stock.

## Bellows Dimensional Information

Bellows are available in three styles:

**532 BB** “Low Profile” with outside dimensions that do not exceed the carriage, constructed of polyurethane coated polyester, maximum ambient temperature of 80°C (175°F).

**532 BC** “High Compression” constructed of a spark resistant Teflon® coated fiberglass and designed to allow for higher compression, maximum ambient temperature exceeds maximum bearing peak temperatures.

**532 BW** “Walk On” capable of handling the harshest environments, including welding and grinding applications, with a 90 kg load bearing capacity.

The bellows can be easily installed in conjunction with the other optional modular seals providing you with an easy upgrade to the standard seal. Installation is simple and requires little time. Retrofitting is possible. The rail ends have to be drilled for the attachment of the bellow clip adapter plate, 532 CR. These can be easily installed on-site in the field or can be supplied from the factory.

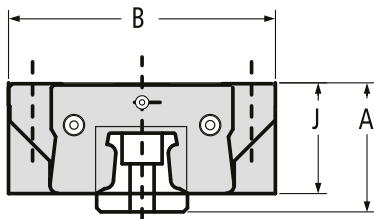

**532 BB “ Profile” Bellows**

Size	Part No.	B	J	A	CR
25	532 BB25	47	30.5	36	0.17
35	532 BB35	70	41.3	47.5	0.15
45	532 BB45	81	51	59	0.15
55	532 BB55	99	58	69	0.10
65	532 BB65	109	65	79	0.10

Customer to specify extended length at time of order, see page 148 for how to calculate.

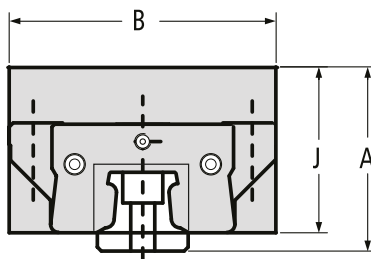

**532 BC “High Compression” Bellows**

Size	Part No.	B	J	A	CR
25	532 BC25	67	40.5	46	0.10
35	532 BC35	90	51.3	57.5	0.07
45	532 BC45	101	61	69	0.07
55	532 BC55	119	68	79	0.06
65	532 BC65	129	75	89	0.06

Customer to specify extended length at time of order, see page 148 for how to calculate.

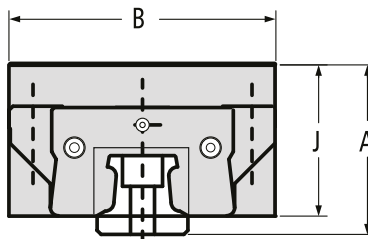

**532 BW “Walk On” Bellows**

Size	Part No.	B	J	A	CR
25	532 BW25	57	35,5	41	0.19
35	532 BW35	77	42	48.2	0.19
45	532 BW45	101	53	61	0.15
55	532 BW55	111	58	69	0.15
65	532 BW65	119	70	84	0.15

Customer to specify extended length at time of order, see page 148 for how to calculate.

## Bellow Clip Adapter Plates

### 532 CC Carriage Bellow Clips – Attachment Plate

The 532 CC Carriage Bellow Clip – Attachment Plate is used to attach the bellows to the carriage. The bellows clip – adapter plate is made of steel.

Size	Part No.
25	532 CC25
35	532 CC35
45	532 CC45
55	532 CC55
65	532 CC65

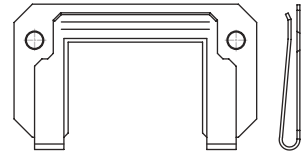

### 532 CR Rail Bellow Clips – Attachment Plate

The 532 CR Rail Bellow Clip – Attachment Plate is used to attach the bellows to the rail. The attaching holes can be drilled in the end of the rail if retrofitting or can be supplied from the factory. The bellows clip – adapter plate is made of steel.

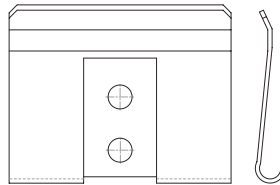

Size	Part No.	Rail Machining Detail					Screw <sup>1</sup>				MinY <sup>2</sup>
		A	B	C	Depth Min	Depth Max	Size	Pitch	Length	Type	
25	532 CR25	7.24	10	11.50	7.7	9.70	M4	0.70	10.00	Button Head Cap Screw	12
35	532 CR35	11.00		17.00							20
45	532 CR45	15.01		22.50							22
55	532 CR55	18.01		26.50							24
65	532 CR65	24.00		31.50							28

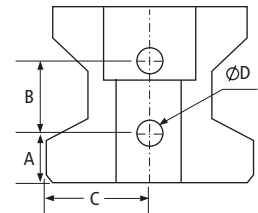

All dimensions in mm.

- Two screws are supplied with each Rail Bellow Clip.
- Min Y dimension to ensure drill depth does not break through rail mounting hole.

## 500 Series Roller Rail Information



### Maintenance and Installation Tools & Accessories: Assembly Rail – 532 MT

An assembly rail is required when the carriage must be removed from the rail and then reinstalled during the installation. It is recommended to leave the carriage on the assembly rail to protect the rollers against con the carriage can be tightened. The assembly rail is made of plastic.

Size	Standard Rail Part Number	Length (mm)	Weight (kg)
25	532 MT25	145	0.062
35	532 MT35	185	0.152
45	532 MT45	230	0.317
55	532 MT55	265	0.525
65	532 MT65	320	0.914



### Standard Rail Plugs and Tape

#### HP plastic plugs

Size	Part Number	Qty per pack	Weight (kg)
25	532 HP25	25	.007
35	532 HP35	25	.014
45	532 HP45	25	.025
55	532 HP55	25	.047
65	532 HP65	25	.053



#### HB brass plugs

Size	Part Number	Qty per pack	Weight (kg)
25	532 HB 25	1	.002
35	532 HB 35	1	.005
45	532 HB 45	1	.008
55	532 HB 55	1	.011
65	532 HB 65	1	.013



#### HS two-piece stainless steel plugs

Size	Part Number	Qty per pack	Weight (kg)
25	532 HS 25	1 set	.003
35	532 HS 35	1 set	.008
45	532 HS 45	1 set	.012
55	532 HS 55	1 set	.019
65	532 HS 65	1 set	.026

## Mylar tape

Size	Part Number	Length
25	532 RT 25	3 m
35	532 RT 35	3 m
45	532 RT 45	3 m
55	532 RT 55	3 m
65	532 RT 65	3 m

## HST Stainless Steel and Brass installation tool

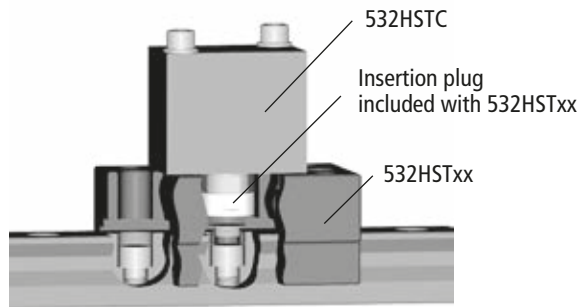

Sliding Block with insertion plug	Weight (kg)
532 HST 25 For size 25 rail	2.0
532 HST 35 For size 35 rail	3.5
532 HST 45 For size 45 rail	3.9
532 HST 55 For size 55 rail	5.4
532 HST 65 For size 65 rail	6.5
Hydraulic cylinder (for all sizes)	Weight (kg)
532 HSTC <sup>1</sup>	0.53

1. Hydraulic fitting size 1/4" -18 NPT, max pressure 120x103 hPa (120 bar).

## Optional 500 Series Rail with Stainless Steel Cover Strip

Size	Rail Coverstrip End Caps	Mounting Tool	Replacement End Caps	Standard Coverstrip Rail	Coverstrip Width (mm)	Max Single PC Length (mm)
	Part Number <sup>1</sup>	Part Number	Part Number <sup>2</sup>	Part Number <sup>3</sup>		
25	532RCS25	532RCT25	532RCP25	522P25C	15	6000
35	532RCS35	532RCT35	532RCP35	522P35C	19	6000
45	532RCS45	532RCT45	532RCP45	522P45C	25	6000
55	532RCS55	532RCT55	532RCP55	522P55C	28.5	6000
65	532RCS65	532RCT65	532RCP65	522P65C	32	6000

- Customer to specify length of rail to be used on at time of order. Delivered piece will be 2 to 3.5 mm longer in order to properly install and fit end caps.
- Two end caps are supplied with each piece of 532RCS ordered.

- P grade accuracy shown for example purposes, S and U grade accuracy are available.
- Cover strip should not be installed more than 3 times.

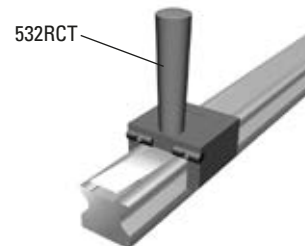
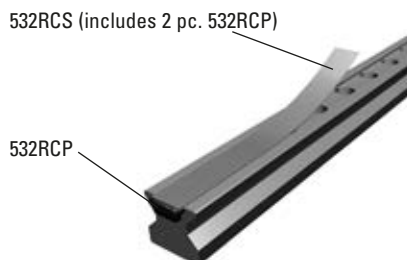

Lubrication Fittings

500 Series Roller  
Profile Rail

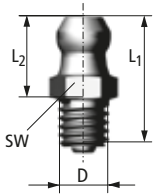

**530LN**  
Hydraulic-type lubricating nipple,  
straight.  
530BF6=2.5 mm/530BF8=4mm

D	L <sub>1</sub>	L <sub>2</sub>	SW
M6	16	10.5	7

\* Note: 1 pc included with each carriage

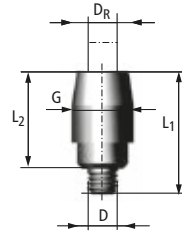

**530LA3**  
Straight screw-in connection M3  
For tubing with ext. diameter D<sub>R</sub> = 3 mm

D	ØG	L <sub>1</sub>	L <sub>2</sub>
M3	6	12	9.5

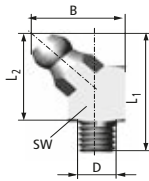

**530LN45**  
Hydraulic-type lubricating nipple,  
45° angle

D	L <sub>1</sub>	L <sub>2</sub>	B	SW
M6	21	15.5	15	9

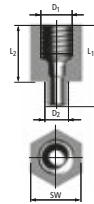

**530LA... Adapter**  
Adapter with hexagon insert bit  
For tubing with ext. diameter = 4 mm

PIN	D <sub>1</sub>	D <sub>2</sub>	L <sub>1</sub>	L <sub>2</sub>
530LA4	G1/8	M6	20	14
530LA5	M8x1	M6	20	14

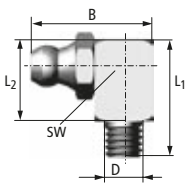

**530LN90**  
Hydraulic-type lubricating nipple,  
90° angle

D	L <sub>1</sub>	L <sub>2</sub>	B	SW
M6	18	12.5	19	9

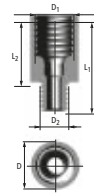

**530LA6**  
Adapter, external round  
For tubing with ext. diameter = 4 mm

D <sub>1</sub>	D <sub>2</sub>	L <sub>1</sub>	L <sub>2</sub>	Ø
M8x1	M6	20	14	10

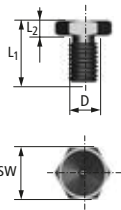

**530LF3**  
Funnel type lubricating nipple M3

D	L <sub>1</sub>	L <sub>2</sub>	SW
M3	6.6	1.6	5

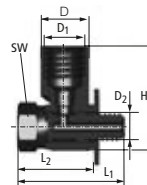

**530BF.. Banjo Fittings**  
For tubing with ext. diameter  
530BF6=2.5 mm/530BF8=4mm

P/N	D <sub>1</sub>	D <sub>2</sub>	L <sub>1</sub>	L <sub>2</sub>	H
530BF6	M6x0.75	M6	22	16	18
530BF8	M8x1	M6	22	15.5	22

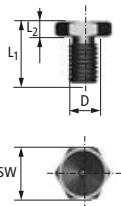

**530LF6**  
Funnel type lubricating nipple M6

D	L <sub>1</sub>	L <sub>2</sub>	SW
M6	9.5	3	7

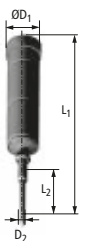

**530LG**  
Grease gun for funnel type  
lubricating nipple M3

L <sub>1</sub>	L <sub>2</sub>	ØD <sub>1</sub>	ØD <sub>2</sub>
210	55	34	5.5

## Accuracy Class

Three tolerances describe the accuracy of a Profile Rail bearing: Running Parallelism, Pair Variation, and Assembly Accuracy. These are measured from the rail base to the center of the carriage top (H), and from the rail reference edge to the center of the carriage reference edge (A3).

Running Parallelism describes the tolerance on H and A3 as a function of axial travel, measured from one carriage down the length of the rail. This is analogous to straightness of travel. As such, parallelism describes attributes of the rail only.

Assembly Accuracy describes the tolerance on H and A3 as a function of a carriage – rail assembly, measured from the nominal dimensions.

Pair Variation describes tolerance on H and A3 as a function of carriages at the same position on a common rail. Pair variation describes carriage precision only.

The accuracy class selected will partially determine the accuracy of the system. Other factors such as mounting surface flatness and straightness also significantly affect system accuracy.

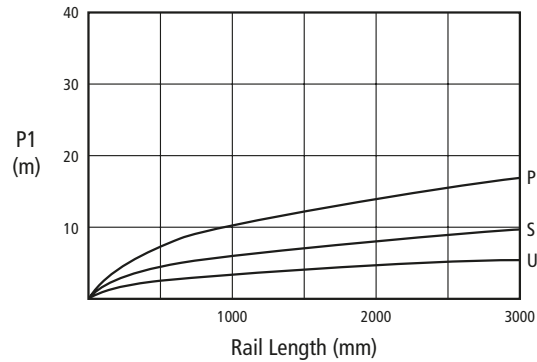
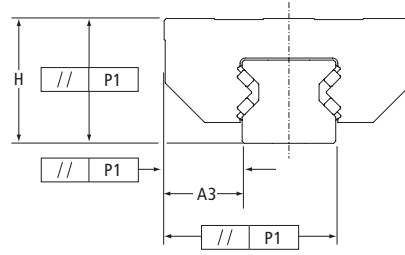

### Tolerances

	Accuracy Class		
	P - Precision	S - Super Precision	U - Ultra Precision
Assembly Accuracy Tolerance on dimension H and A3 (measured at middle of carriage at any point along rail)	±20	±10	±5
Pair Variation Max variation in dimensions H and A3 measured on multiple carriages mounted on the same rail (measured at the middle of carriage at same position on rail)	10	5	3
Running Parallelism	40	20	10

All values in  $\mu\text{m}$

## Preload

Three Preload classes are available with the 500 Series Roller Profile rail carriages. Preload will minimize elastic deformation caused by external forces resulting in increased rigidity.

### Preload Accuracy Combinations

Accuracy Class	Preload		
	0.03C <sup>1</sup>	0.08C <sup>1</sup>	0.13C <sup>1</sup>
P, S, U	1	2	3

1. C = Dynamic load capacity of the bearing



**NOTES:**

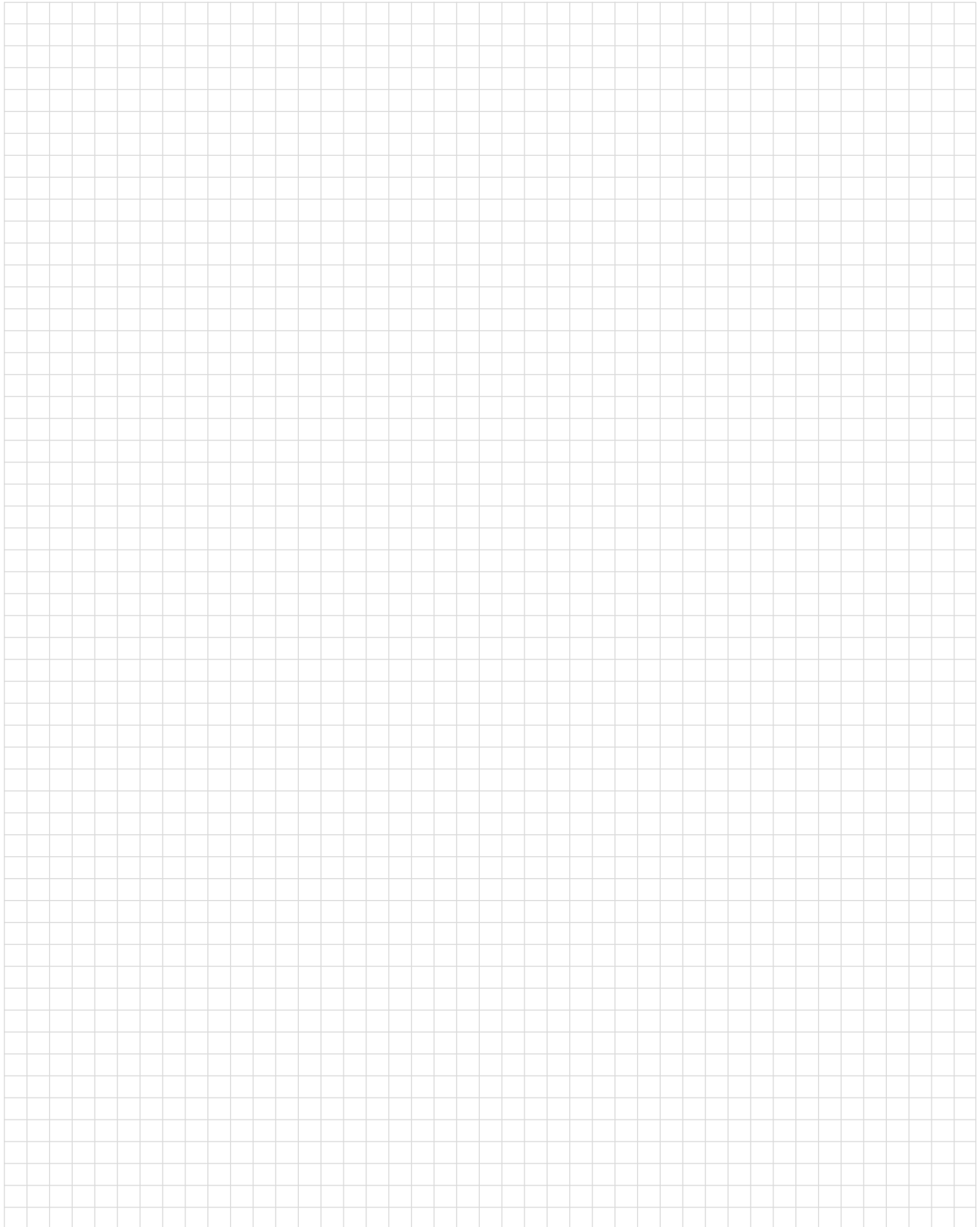

## Overview of Thomson 400 Series Profile Rail Linear Guides

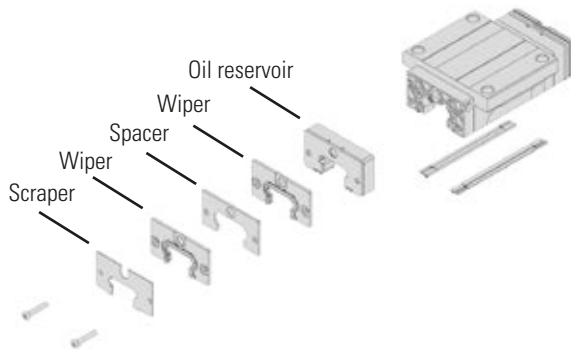
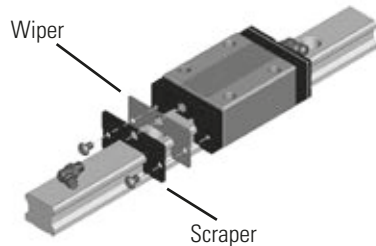
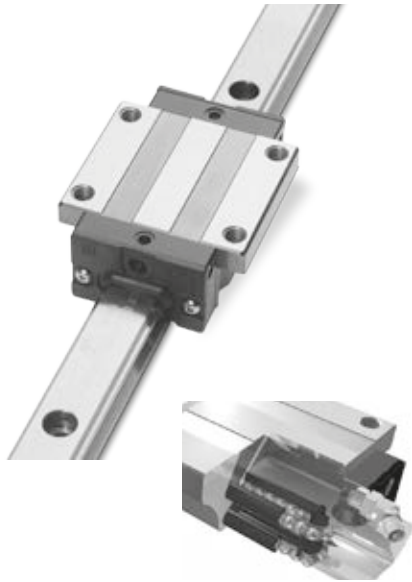

### Features and Benefits

The 400 Series Profile Rail Linear Guide is the newest addition to the Thomson Linear Guide product line. The 400 Series is a cost effective, transport grade Profile Rail solution for cost-sensitive applications, and is a drop-in replacement with industry-standard envelope and hole patterns. Double-faced ball track bearing arrangements provide compliance during installation as well as equal load carrying capacity in all directions. Caged and non-caged carriages utilize the same rail design. This enables efficient use of inventory, as only one rail type needs to be stocked for either carriage type.

### Low Noise and Vibration

Polymer ball-return tube reduces noise while retaining lubrication.

### Modular Accessory Options

Standard double lip end and longitudinal seals retain lubrication while protecting the bearing from contamination. Additional seals and scrapers available.

### Metal Scraper

The **Type 431 ZZ Metal Scraper** made of stainless steel, serves as an added protection to the seal lips against large dirt particles, metal shavings or chips. Large contaminants are easily pushed away providing an extra level of protection to the seal lips. The Metal Scraper is easily installed in conjunction with the other optional modular accessories providing you with an easy upgrade to the standard seal. These can be easily installed on-site in the field or can be supplied from the factory.

### Additional Seal

The **431 WR seal** provide an additional level of protection from contaminants to the assembly. These additional components can easily be added on-site without removing the carriage from the rail. They are supplied with the required screws to make the installation simple and is constructed from SPCC Steel and are nickel plated. These seals can be used in conjunction with other optional modular accessories providing an easy upgrade to the standard seal. These can be easily installed on-site in the field or can be supplied from the factory. When using double seals, a spacer is installed between the seals. This helps in better sealing of the carriage.

### Oil Reservoir

The **Type 431 OW oil reservoir** is a cost effective, automatic lubrication system. It is constructed with an integrated oil reservoir that provides a uniform, consistent lubricating oil

## Overview of Thomson 400 Series Profile Rail Linear Guides

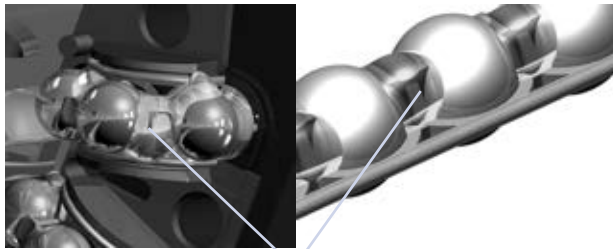
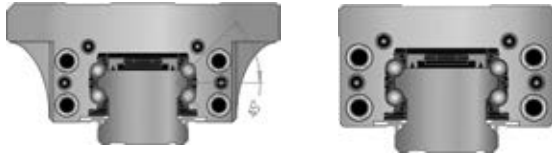

Lubricant

New design

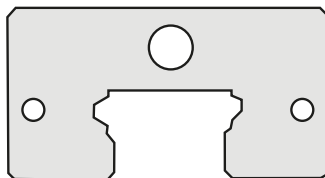

Old design

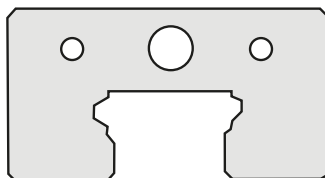

to the ball paths for extended periods of time. The Type 431 OW oil reservoir lubrication plate eliminates the need for a routine maintenance schedule, assures lubrication gets to the required points, can be refilled if required. It usually doubles the gap between service cycle. The Type 431 OW oil reservoir can be easily installed in conjunction with other optional modular accessories providing an easy upgrade to the standard seals. These can be easily installed on-site in the field or can be supplied from the factory .

### Lubrication Channels

Channels direct lubricant to individual ball tracks to maximize lubrication effectiveness.

### Double-Faced Ball Tracks

The 400 Series Linear Guide utilizes a 45°, face-to-face bearing arrangement, resulting in equal load-carrying capacity in all directions. The primary advantage of face-to-face configuration is that the rails are much more tolerant of mounting surface inaccuracies. This enables automation machine builders to reduce cost further by not having to prepare high tolerance mounting surfaces.

### 400 Series Ball Cage

The 413 ball cage option provides:

- Increased running smoothness
- Low noise at high speeds
- Individual ball lubricant reservoirs

### New endcap design on our 400 Series carriages

The screw position on the end cap is being moved from top to center.

Advantages:

- Moving the screw position toward the center, helps to better secure the scrapper and efficiently scrap off dust on rail.
- This position provides better prevention from dust entering the ball tracks and improves carriage operation.
- All carriage dimensions remain exactly the same. Functioning of the carriage will not be affected.
- Accessories like wiper and scraper will also be changed accordingly to match the new hole pattern.
- New carriages will be available, once existing stock (with current/old endcap style) is used up.

## 400 Series Part Numbering Description

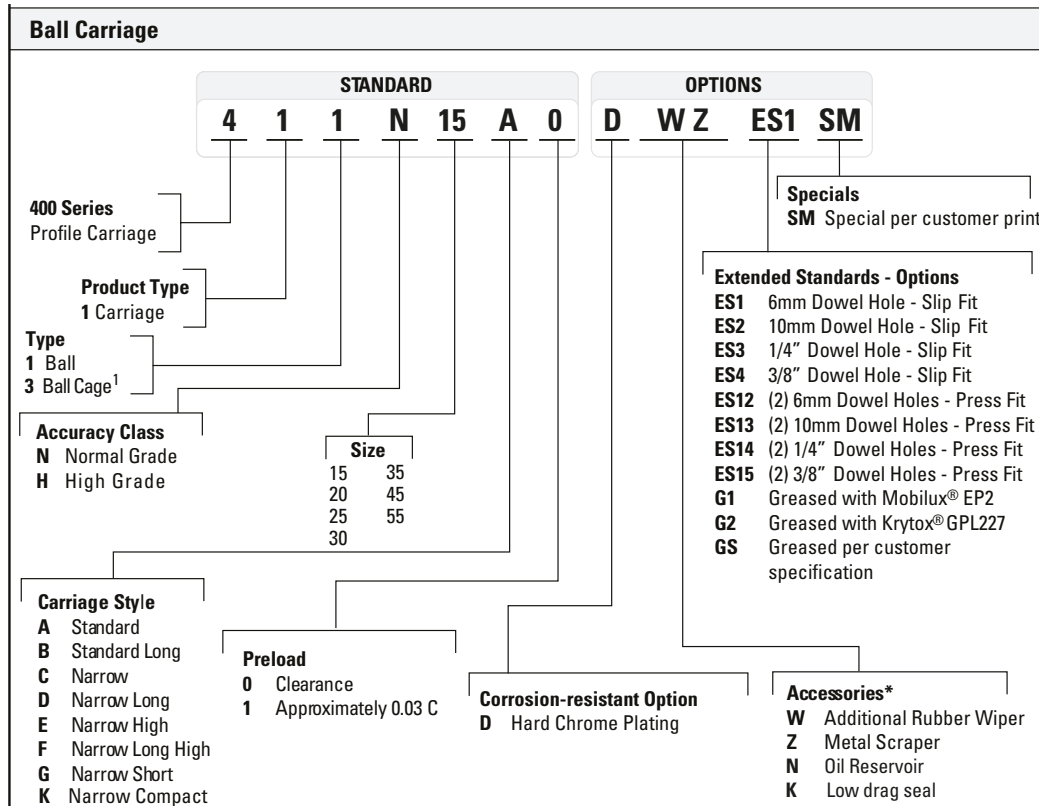

1. Carriage does not retain ball bearings when end cap is removed. Removal of end caps can result in loss of ball bearings.

\* Long life lube block and bellows may be available as options if desired, based on the opportunity. Please contact Customer Support for more details.

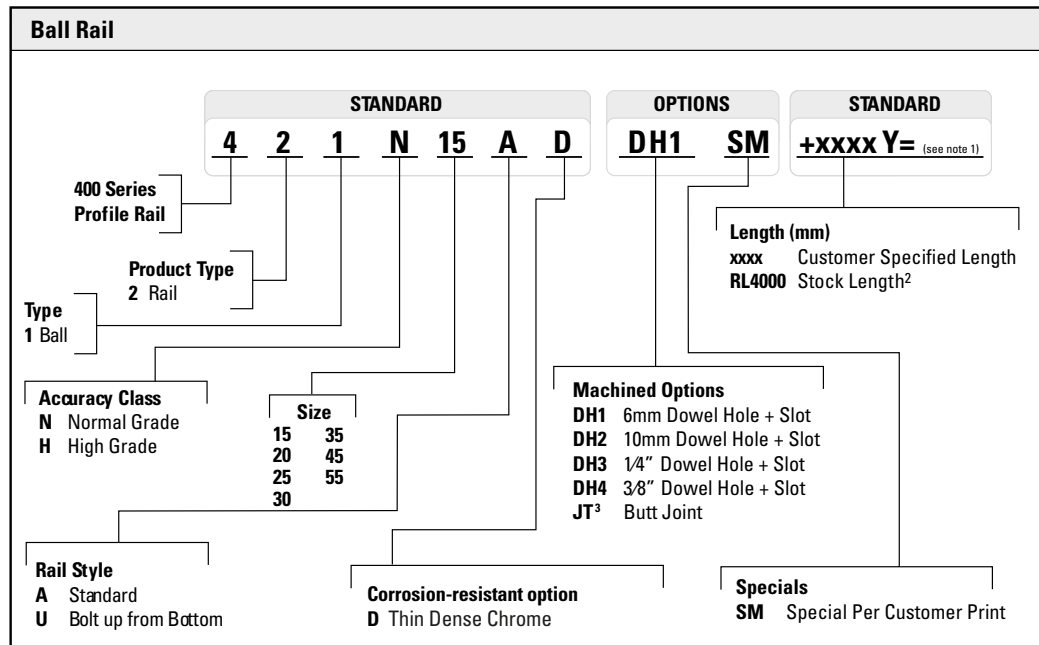

1. Y = Distance from end of rail to center of first mounting hole, Y1 = Y2 unless specified.

2. Stock length of rails are considered random length, total length may exceed specified length, and Y1/Y2 are not equal. To be used only by customer who will cut to length.

3. Customer drawing required at time of quote and order.

### 400 Series Part Numbering Description

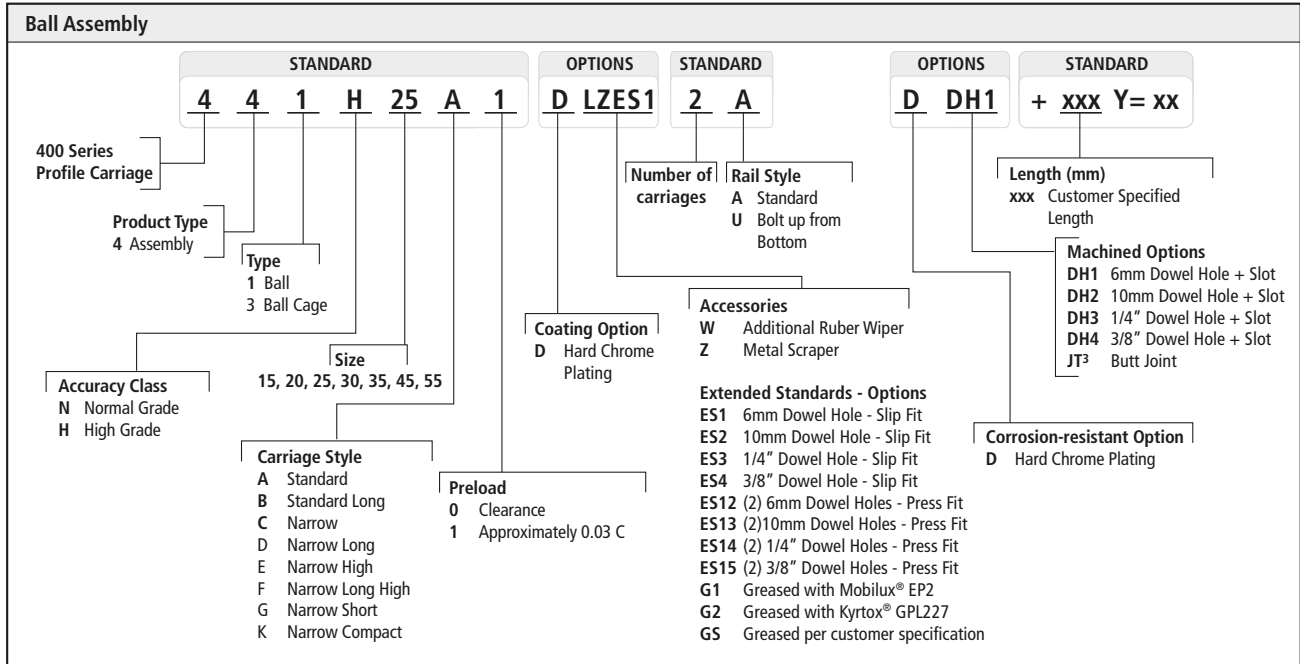

400 Series Profile Rail

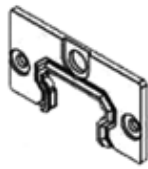
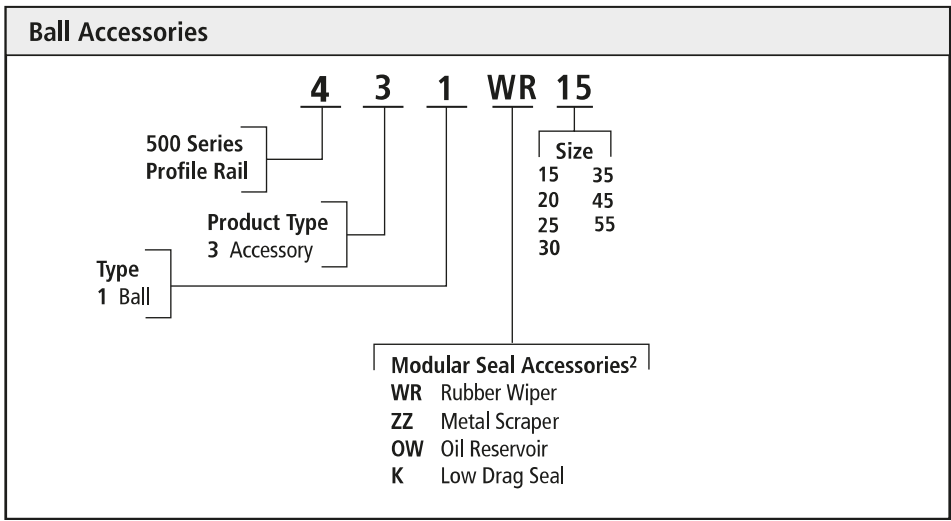

Wiper



Scraper

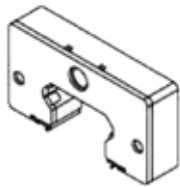

Oil Reservoir



Low Drag Seal

## 400 Series Specifications

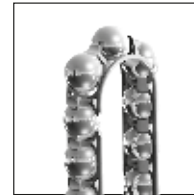

Ball Cage

### Dimensions - Type 411 and 413, Style A and B

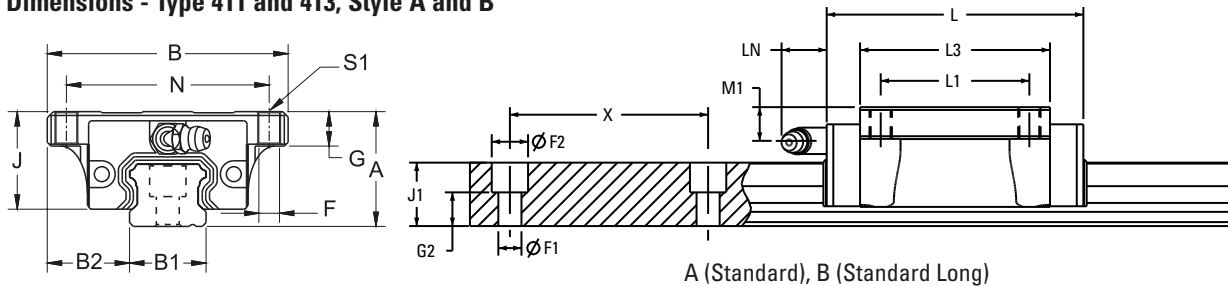

#### Type 411/413 (No Ball Cage/Ball Cage) - Style A (Standard)

Size	Assembly [mm]				Carriage [mm]										Rail [mm]					
	A	B	B2	J	L	N	L1	S1	F	G	L3	Oil H	M1	LN	B1 +0.02 -0.05	J1	X	F1	F2	G2
15	24	47	16.0	20.7	58.6	38	30	M5	4.4	8.0	40.2	M4 X 0.7	5.5	(5.0)	15	13.0	60	4.5	7.5	7.0
20	30	63	21.5	25.5	69.3	53	40	M6	5.4	9.0	48.5	M6 X 1.0	7.1	(15.6)	20	16.3	60	6.0	9.5	7.8
25	36	70	23.5	30.2	79.2	57	45	M8	7.0	10.0	57.5	M6 X 1.0	10.2	(15.6)	23	19.2	60	7.0	11.0	10.2
30	42	90	31.0	35.0	94.8	72	52	M10	8.6	11.0	67.8	M6 X 1.0	8	(15.6)	28	22.8	80	9.0	14.0	10.8
35	48	100	33.0	40.5	111.5	82	62	M10	8.6	12.0	80.5	M6 X 1.0	8	(16.0)	34	26.0	80	9.0	14.0	14.0
45	60	120	37.5	51.1	129.0	100	80	M12	10.6	15.5	94.0	M8 X 1.25	14.4	(16.0)	45	31.1	105	14.0	20.0	14.1
55	70	140	43.5	57.3	155.0	116	95	M14	12.6	18.5	116.0	M8 X 1.25	14.0	(16.0)	53	38.0	120	16.0	23.0	18.0

#### Type 411/413 (No Ball Cage/Ball Cage) - Style B - (Standard Long)

Size	Assembly [mm]				Carriage [mm]										Rail [mm]					
	A	B	B2	J	L	N	L1	S1	F	G	L3	Oil H	M1	LN	B1 +0.02 -0.05	J1	X	F1	F2	G2
15	24	47	16.0	20.7	66.1	38	30	M5	4.4	8.0	47.7	M4 X 0.7	5.5	(5.0)	15	13.0	60	4.5	7.5	7.0
20	30	63	21.5	25.5	82.1	53	40	M6	5.4	9.0	61.3	M6 X 1.0	7.1	(15.6)	20	16.3	60	6.0	9.5	7.8
25	36	70	23.5	30.2	93.9	57	45	M8	7.0	10.0	72.2	M6 X 1.0	10.2	(15.6)	23	19.2	60	7.0	11.0	10.2
30	42	90	31.0	35.0	105.0	72	52	M10	8.6	11.0	78.0	M6 X 1.0	8	(15.6)	28	22.8	80	9.0	14.0	10.8
35	48	100	33.0	40.5	123.5	82	62	M10	8.6	12.0	92.5	M6 X 1.0	8	(16.0)	34	26.0	80	9.0	14.0	14.0
45	60	120	37.5	51.1	145.0	100	80	M12	10.6	15.5	110.0	M8 X 1.25	14.4	(16.0)	45	31.1	105	14.0	20.0	14.1
55	70	140	43.5	57.3	193.0	116	95	M14	12.6	18.5	154.0	M8 X 1.25	14.0	(16.0)	53	38.0	120	16.0	23.0	18.0

## 400 Series Specifications

### Performance - Type 411 and 413, Style A and B

Applications with a single rail and a single carriage require the calculation of moment loads for all three axes. Double rail and double carriage configurations can eliminate moment loading on the constrained axes.

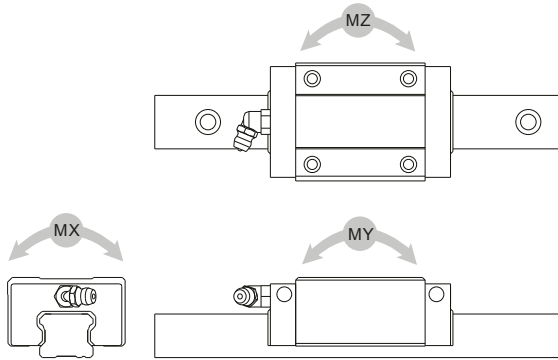

Type	Size	Style	Load Rating <sup>1</sup>		Static moment (Nm) <sup>2</sup>			Dynamic moment (Nm) <sup>2</sup>			Weights	
			C (N)	Co (N)	MX	MY	MZ	MX	MY	MZ	Carriage (kg)	Rail (kg/m)
411/413	15	A	9,300	19,600	135	118	118	65	56	56	0.21	1.28
411/413	15	B	11,300	23,700	164	169	169	78	80	80	0.23	1.28
411/413	20	A	14,300	30,500	285	221	221	134	104	104	0.40	2.15
411/413	20	B	18,600	39,500	370	361	361	174	170	170	0.46	2.15
411/413	25	A	20,100	41,100	440	352	352	216	173	173	0.57	2.88
411/413	25	B	25,900	52,800	567	568	568	278	279	279	0.72	2.88
411/413	30	A	29,700	54,600	707	551	551	386	300	300	1.10	4.45
411/413	30	B	38,500	70,700	915	822	822	499	447	447	1.34	4.45
411/413	35	A	42,400	81,100	1283	973	973	671	508	508	1.50	6.25
411/413	35	B	52,900	101,400	1604	1398	1398	838	730	730	1.90	6.25
411/413	45	A	58,000	108,900	2302	1525	1525	1225	812	812	2.27	9.60
411/413	45	B	69,000	129,500	2739	2124	2124	1458	1130	1130	2.68	9.60
411/413	55	A	69,800	133,400	3306	2306	2306	1730	1207	1207	3.44	13.80
411/413	55	B	94,200	178,900	4431	4104	4104	2335	2162	2162	4.63	13.80

1. The dynamic load and moment ratings are based on the travel life of 50 km.

2. Moment ratings are the maximum moment load that should be applied to the bearing when there is no relative motion between the carriage and the rail.

### Bearing Travel Life Comparison

$$L = (C/F)^3 \times 100\text{km}$$

where:

L = travel life, km

C = dynamic load rating, N

F = applied dynamic load, N

$$C_{\min} = F \left( \frac{L}{100} \right)^{1/3}$$

where:

C<sub>min</sub> = minimum required dynamic load rating, N

F = applied dynamic load, N

L = required travel life, km

#### Operating Parameters:

Maximum Velocity: 3 m/s

Maximum Acceleration: 50 m/s<sup>2</sup>

Temperature: Min: - 40° C

Max: 80° C

Max peak: 120° C short time\*

\*without bellows

## 400 Series Specifications

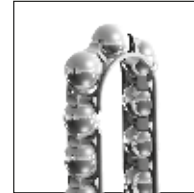

Ball Cage

### Dimensions - Type 411 and 413, Style C, D and K

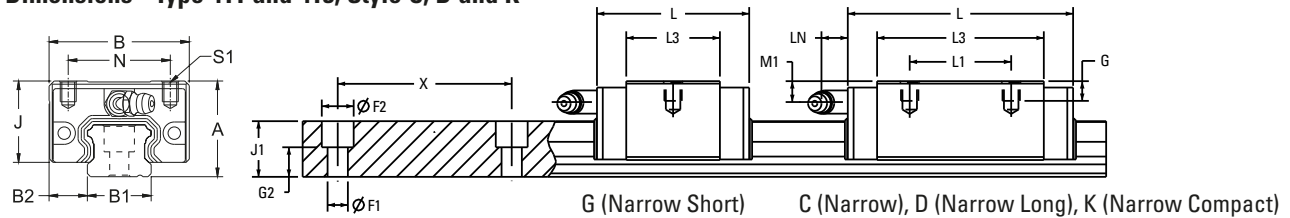

#### Type 411/413 (No Ball Cage/Ball Cage) - Style C (Narrow)

Size	Assembly [mm]				Carriage [mm]									Rail [mm]					
	A	B	B2	J	L	N	L1	S1	G	L3	Oil H	M1	LN	B1 +0.02 - .05	J1	X	F1	F2	G2
15	24	34	9.5	20.7	58.6	26	26	M4	4.8	40.2	M4 X 0.7	5.5	(5.0)	15	13.0	60	4.5	7.5	7.0
20	30	44	12.0	25.5	69.3	32	36	M5	6.5	48.5	M6 X 1.0	7.1	(15.6)	20	16.3	60	6.0	9.5	7.8
25	36	48	12.5	30.2	79.2	35	35	M6	9.0	57.5	M6 X 1.0	10.2	(15.6)	23	19.2	60	7.0	11.0	10.2
30	42	60	16.0	35.0	94.8	40	40	M8	10.0	67.8	M6 X 1.0	8.0	(15.6)	28	22.8	80	9.0	14.0	10.8
35	48	70	18.0	40.5	111.5	50	50	M8	10.0	80.5	M6 X 1.0	8.0	(15.6)	34	26.0	80	9.0	14.0	14.0
45	60	86	20.5	51.1	129.0	60	60	M10	15.5	94.0	M8 X 1.25	14.4	(16.0)	45	31.1	105	14.0	20.0	14.1
55	70	100	23.5	57.3	155.0	75	75	M12	18.0	116.0	M8 X 1.25	14.0	(16.0)	53	38.0	120	16.0	23.0	18.0

#### Type 411/413 (No Ball Cage/Ball Cage) - Style D (Narrow Long)

Size	Assembly [mm]				Carriage [mm]									Rail [mm]					
	A	B	B2	J	L	N	L1	S1	G	L3	Oil H	M1	LN	B1 +0.02 - .05	J1	X	F1	F2	G2
15	24	34	9.5	20.7	66.1	26	26	M4	4.8	47.7	M4 X 0.7	5.5	(5.0)	15	13.0	60	4.5	7.5	7.0
25	36	48	12.5	30.2	108.6	35	50	M6	9.0	86.9	M6 X 1.0	10.2	(15.6)	23	19.2	60	7.0	11.0	10.2
30	42	60	16.0	35.0	130.5	40	60	M8	10.0	103.5	M6 X 1.0	8.0	(15.6)	28	22.8	80	9.0	14.0	10.8
35	48	70	18.0	40.5	153.5	50	72	M8	10.0	122.5	M6 X 1.0	8.0	(15.6)	34	26.0	80	9.0	14.0	14.0
45	60	86	20.5	51.1	174.0	60	80	M10	15.5	139.0	M8 X 1.25	14.4	(16.0)	45	31.1	105	14.0	20.0	14.1
55	70	100	23.5	57.3	210.0	75	95	M12	18.0	171.0	M8 X 1.25	14.0	(16.0)	53	38.0	120	16.0	23.0	18.0

#### Type 411/413 (No Ball Cage/Ball Cage) - Style K (Narrow Compact)

Size	Assembly [mm]				Carriage [mm]									Rail [mm]					
	A	B	B2	J	L	N	L1	S1	G	L3	Oil H	M1	LN	B1 +0.02 - .05	J1	X	F1	F2	G2
20	28	42	11.0	23.5	69.3	32	32	M5	5.5	48.5	M6 X 1.0	5.1	(15.6)	20	16.3	60	6.0	9.5	7.8
25	33	48	12.5	27.2	79.2	35	35	M6	6.8	57.5	M6 X 1.0	7.2	(15.6)	23	19.2	60	7.0	11.0	10.2



## 400 Series Specifications

### Performance - Type 411 and 413, Style C, D and K

Applications with a single rail and a single carriage require the calculation of moment loads for all three axes. Double rail and double carriage configurations can eliminate moment loading on the constrained axes.

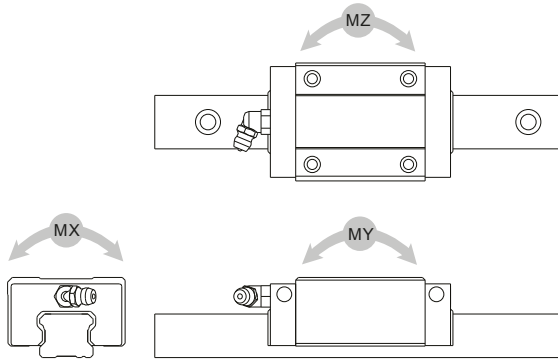

Type	Size	Style	Load Rating <sup>1</sup>		Static moment (Nm) <sup>2</sup>			Dynamic moment (Nm) <sup>2</sup>			Weights	
			C (N)	Co (N)	MX	MY	MZ	MX	MY	MZ	Carriage (kg)	Rail (kg/m)
411/413	15	C	9,300	19,600	135	118	118	65	56	56	0.17	1.28
411/413	15	D	11,300	23,700	170	168	168	78	80	80	0.18	1.28
411/413	20	C	14,300	30,500	285	221	221	134	104	104	0.31	2.15
411/413	20	K	14,300	30,500	285	221	221	166	129	129	0.31	2.15
411/413	25	C	20,100	41,100	440	352	352	216	173	173	0.40	2.88
411/413	25	D	29,200	63,300	680	820	820	313	378	378	0.67	2.88
411/413	25	K	20,100	41,100	440	352	352	267	213	213	0.38	2.88
411/413	30	C	29,700	54,600	707	551	551	386	300	300	0.80	4.45
411/413	30	D	42,900	86,700	1123	1338	1338	555	661	661	1.16	4.45
411/413	35	C	42,400	81,100	1283	973	973	671	508	508	1.20	6.25
411/413	35	D	58,300	125,300	1983	2288	2288	922	1063	1063	1.84	6.25
411/413	45	C	58,000	108,900	2302	1525	1525	1225	812	812	1.64	9.60
411/413	45	D	79,700	163,300	3452	3382	3382	1684	1651	1651	2.42	9.60
411/413	55	C	69,800	133,400	3306	2306	2306	1730	1207	1207	2.67	13.80
411/413	55	D	157,700	253,600	6284	6462	6462	3165	3255	3255	3.97	13.80

1. The dynamic load and moment ratings are based on the travel life of 50 km.

2. Moment ratings are the maximum moment load that should be applied to the bearing when there is no relative motion between the carriage and the rail.

### Bearing Travel Life Comparison

$$L = (C/F)^3 \times 100\text{km}$$

where:

L = travel life, km

C = dynamic load rating, N

F = applied dynamic load, N

$$C_{\min} = F \left( \frac{L}{100} \right)^{1/3}$$

where:

C<sub>min</sub> = minimum required

dynamic load rating, N

F = applied dynamic load, N

L = required travel life, km

Operating Parameters:

Maximum Velocity: 3 m/s

Maximum Acceleration: 50 m/s<sup>2</sup>

Temperature: Min: -40° C

Max: 80° C

Max peak: 120° C short time\*

\*without bellows

## 400 Series Specifications

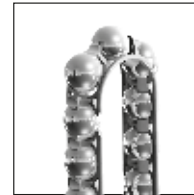

Ball Cage

### Dimensions - Type 411 and 413, Style E and F

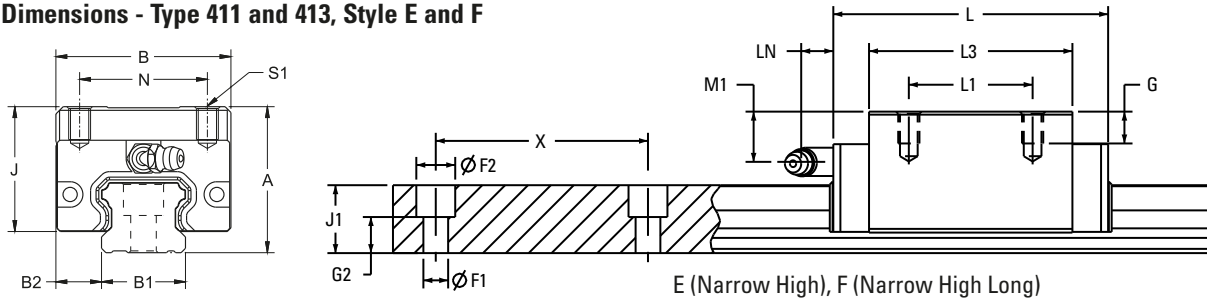

#### Type 411/413 (No Ball Cage/Ball Cage) - Style E (Narrow High)

Size	Assembly [mm]				Carriage [mm]								Rail [mm]						
	A	B	B2	J	L	N	L1	S1	G	L3	Oil H	M1	LN	B1 +0.02 -0.05	J1	X	F1	F2	G2
15	28	34	9.5	24.7	58.6	26	26	M4	6.0	40.2	M4 X 0.7	9.5	(5.0)	15	13.0	60	4.5	7.5	7.0
25	40	48	12.5	34.2	79.2	35	35	M6	9.0	57.5	M6 X 1.0	14.2	(15.6)	23	19.2	60	7.0	11.0	10.2
30	45	60	16.0	38.0	94.8	40	40	M8	12.0	67.8	M6 X 1.0	11.0	(15.6)	28	22.8	80	9.0	14.0	10.8
35	55	70	18.0	47.5	111.5	50	50	M8	12.0	80.5	M6 X 1.0	15.0	(15.6)	34	26.0	80	9.0	14.0	14.0
45	70	86	20.5	61.1	129.0	60	60	M10	18.0	94.0	M8 X 1.25	24.4	(16.0)	45	31.1	105	14.0	20.0	14.1
55	80	100	23.5	67.3	155.0	75	75	M12	18.0	116.0	M8 X 1.25	14	(16.0)	53	38.0	120	16.0	23.0	18.0

#### Type 411/413 (No Ball Cage/Ball Cage) - Style F - Narrow High Long

Size	Assembly [mm]				Carriage [mm]								Rail [mm]						
	A	B	B2	J	L	N	L1	S1	G	L3	Oil H	M1	LN	B1 +0.02 -0.05	J1	X	F1	F2	G2
20	30	44	12.0	25.5	82.1	32	50	M5	6.5	61.3	M6 X 1.0	7.1	(15.6)	20	16.3	60	6.0	9.5	7.8
25	40	48	12.5	34.2	93.9	35	50	M6	9.0	72.2	M6 X 1.0	14.2	(15.6)	23	19.2	60	7.0	11.0	10.2
30	45	60	16.0	38.0	105.0	40	60	M8	12.0	78.0	M6 X 1.0	11.0	(15.6)	28	22.8	80	9.0	14.0	10.8
35	55	70	18.0	47.5	123.5	50	72	M8	12.0	92.5	M6 X 1.0	15.0	(15.6)	34	26.0	80	9.0	14.0	14.0
45	70	86	20.5	61.1	145.0	60	80	M10	18.0	110.0	M8 X 1.25	24.4	(16.0)	45	31.1	105	14.0	20.0	14.1
55	80	100	23.5	67.3	193.0	75	95	M12	18.0	154.0	M8 X 1.25	14	(16.0)	53	38.0	120	16.0	23.0	18.0

\*Note: Mounting hole dimensions of 411 and 413 F Style carriages are different.

## 400 Series Specifications

### Performance - Type 411 and 413, Style E and F

Applications with a single rail and a single carriage require the calculation of moment loads for all three axes. Double rail and double carriage configurations can eliminate moment loading on the constrained axes.

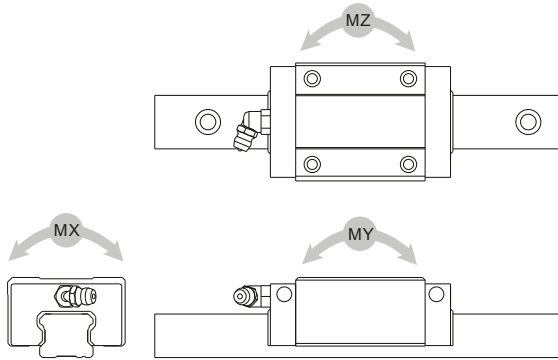

Type	Size	Style	Load Rating <sup>1</sup>		Static moment (Nm) <sup>2</sup>			Dynamic moment (Nm) <sup>2</sup>			Weights	
			C (N)	Co (N)	MX	MY	MZ	MX	MY	MZ	Carriage (kg)	Rail (kg/m)
411/413	15	E	9,300	19,600	135	118	118	65	65	56	0.19	1.28
411/413	20	F	18,600	39,500	370	361	361	174	170	170	0.36	2.15
411/413	25	E	20,100	41,100	440	352	352	267	213	213	0.45	2.88
411/413	25	F	25,900	52,800	567	568	568	278	279	279	0.66	2.88
411/413	30	E	29,700	54,600	707	551	551	386	300	300	0.91	4.45
411/413	30	F	38,500	70,700	915	822	822	499	447	447	1.04	4.45
411/413	35	E	42,400	81,100	1283	973	973	671	508	508	1.50	6.25
411/413	35	F	52,900	101,400	1604	1398	1398	838	730	730	1.80	6.25
411/413	45	E	58,000	108,900	2302	1525	1525	1225	812	812	2.28	9.60
411/413	45	F	69,000	129,500	2739	2124	2124	1458	1130	1133	2.67	9.60
411/413	55	E	69,800	133,400	3306	2306	2306	1730	1207	1207	3.42	13.80
411/413	55	F	94,200	178,900	4431	4104	4104	2335	2162	2162	5.08	13.80

1. The dynamic load and moment ratings are based on the travel life of 50 km.

2. Moment ratings are the maximum moment load that should be applied to the bearing when there is no relative motion between the carriage and the rail.

### Bearing Travel Life Comparison

$$L = (C/F)^3 \times 100\text{km}$$

where:

L = travel life, km

C = dynamic load rating, N

F = applied dynamic load, N

$$C_{\min} = F \left( \frac{L}{100} \right)^{1/3}$$

where:

C<sub>min</sub> = minimum required dynamic load rating, N

F = applied dynamic load, N

L = required travel life, km

Operating Parameters:

Maximum Velocity: 3 m/s

Maximum Acceleration: 50 m/s<sup>2</sup>

Temperature:

Min: -40° C

Max: 80° C

Max peak: 120° C short time\*

\*without bellows

## 400 Series Specifications

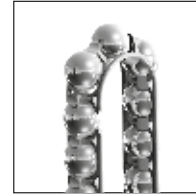

Ball Cage

### Dimensions - Type 411 and 413, Style G

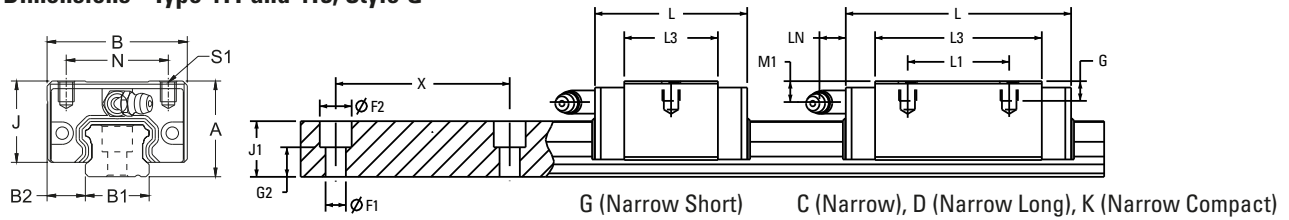

### Type 411/413 (No Ball Cage/Ball Cage) - Style G (Narrow Short)

Size	Assembly [mm]				Carriage [mm]									Rail [mm]					
	A	B	B2	J	L	N	L1	S1	G	L3	Oil H	M1	LN	B1 +0.02 -0.05	J1	X	F1	F2	G2
15	24	34	9.5	20.7	40.6	26	--	M4	4.8	22.2	M4 X 0.7	5.5	(5.0)	15	13.0	60	4.5	7.5	7.0
20	28	42	11.0	23.5	48.3	32	--	M5	5.5	27.5	M6 X 1.0	5.1	(15.6)	20	16.3	60	6.0	9.5	7.8
25	33	48	12.5	27.2	54.0	35	--	M6	6.8	32.3	M6 X 1.0	7.2	(15.6)	23	19.2	60	7.0	11.0	10.2
30	42	60	16.0	35.0	64.2	40	--	M8	10.0	37.2	M6 X 1.0	8.0	(15.6)	28	22.8	80	9.0	14.0	10.8
35	48	70	18.0	40.5	75.5	50	--	M8	10.0	44.5	M6 X 1.0	8.0	(15.6)	34	26.0	80	9.0	14.0	14.0

## 400 Series Specifications

### Performance - Type 411 and 413, Style G

Applications with a single rail and a single carriage require the calculation of moment loads for all three axes. Double rail and double carriage configurations can eliminate moment loading on the constrained axes.

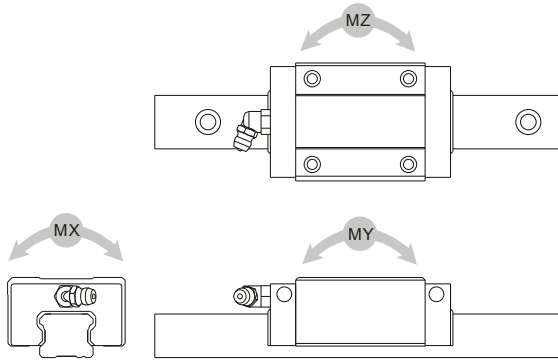

Type	Size	Style	Load Rating <sup>1</sup>		Static moment (Nm) <sup>2</sup>			Dynamic moment (Nm) <sup>2</sup>			Weights	
			C (N)	Co (N)	MX	MY	MZ	MX	MY	MZ	Carriage (kg)	Rail (kg/m)
411/413	15	G	4,600	9,800	68	32	32	32	16	16	0.10	1.28
411/413	20	G	7,400	15,700	146	65	65	69	30	30	0.17	2.15
411/413	25	G	10,300	21,000	226	101	101	111	49	49	0.21	2.88
411/413	30	G	14,700	27,000	350	150	150	191	81	81	0.50	4.45
411/413	35	G	21,200	40,700	644	270	270	336	141	141	0.80	6.25

1. The dynamic load and moment ratings are based on the travel life of 50 km.

2. Moment ratings are the maximum moment load that should be applied to the bearing when there is no relative motion between the carriage and the rail.

### Bearing Travel Life Comparison

$$L = (C/F)^3 \times 100\text{km}$$

where:

L = travel life, km

C = dynamic load rating, N

F = applied dynamic load, N

$$C_{\min} = F \left( \frac{L}{100} \right)^{1/3}$$

where:

C<sub>min</sub> = minimum required dynamic load rating, N

F = applied dynamic load, N

L = required travel life, km

#### Operating Parameters:

Maximum Velocity: 3 m/s

Maximum Acceleration: 50 m/s<sup>2</sup>

Temperature: Min: -40° C

Max: 80° C

Max peak: 120° C short time\*

\*without bellows

## 400 Series Life Calculations and Tolerances

### Bearing Travel Life Calculation

$$L = (C/F)^3 \times 50 \text{ km}$$

where:

L = travel life, km

C = 50 km dynamic load rating

F = applied dynamic load, N

$$C_{\min} = \left(\frac{L}{50}\right)^{1/3} F$$

where:

$C_{\min}$  = minimum required dynamic load rating, N

F = applied dynamic load, N

L = required travel life, km

#### Operating Parameters:

Maximum Velocity: 5 m/s

Maximum Acceleration: 100 m/s<sup>2</sup>

Temperature: Min: -40° C

Max: 80° C

Max peak: 120° C short time\*

\*without bellows

Deflection charts are available on [www.thomsonlinear.com](http://www.thomsonlinear.com).

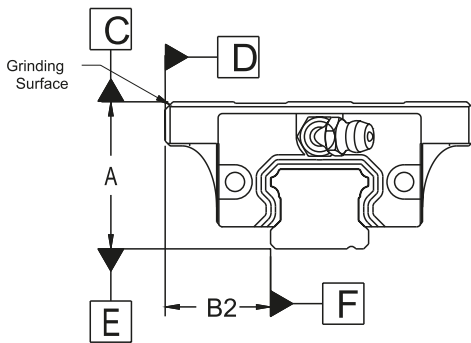

Grade	Normal (N)	High (H)
Height Tolerance (A)	± 0.1	± 0.04
Width Tolerance (B2)	± 0.1	± 0.04
Pair variation max (ΔA)	0.03	0.02
Pair variation max (ΔB2)	0.03	0.02
Running parallelism of carriage surface C with respect to surface E.	Δ C refer to Fig. 1-1	
Running parallelism of carriage surface D with respect to surface F.	Δ D refer to Fig. 1-1	

All items in mm.

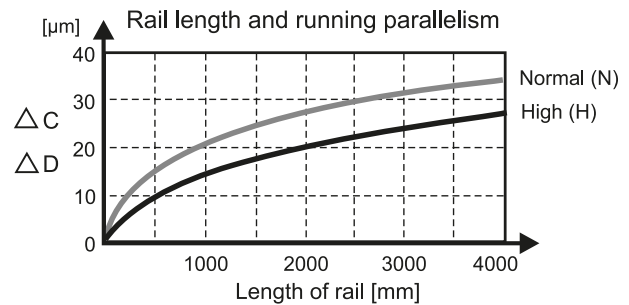
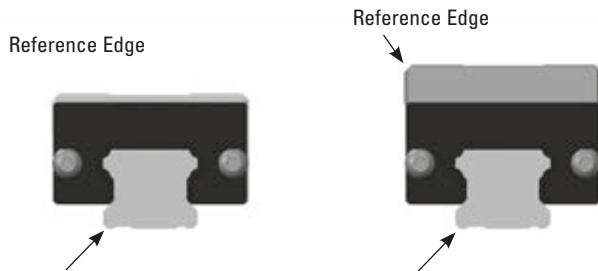

## 400 Series Running Smoothness

### Bearing Travel Life Calculation

$$L = (C/F)^3 \times 50 \text{ km}$$

where:

L = travel life, km

C = 50 km dynamic load rating

F = applied dynamic load, N

$$C_{\min} = \left(\frac{L}{50}\right)^{1/3} F$$

where:

$C_{\min}$  = minimum required

dynamic load rating, N

F = applied dynamic load, N

L = required travel life, km

### Operating Parameters:

Maximum Velocity: 5 m/s

Maximum Acceleration: 100 m/s<sup>2</sup>

Temperature: Min: -40° C

Max: 80° C

Max peak: 120° C short time\*

\*without bellows

Deflection charts are available on [www.thomsonlinear.com](http://www.thomsonlinear.com).

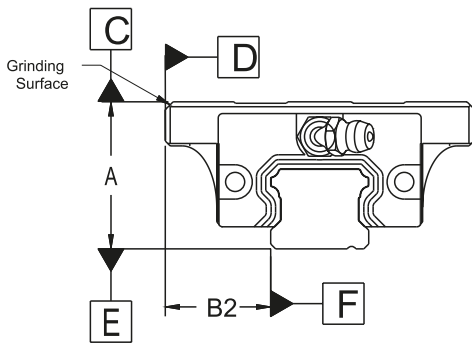

Grade Item	Normal (N)	High (H)
Height Tolerance (A)	± 0.1	± 0.04
Width Tolerance (B2)	± 0.1	± 0.04
Pair variation max (ΔA)	0.03	0.02
Pair variation max (ΔB2)	0.03	0.02
Running parallelism of carriage surface C with respect to surface E.	Δ C refer to Fig. 1-1	
Running parallelism of carriage surface D with respect to surface F.	Δ D refer to Fig. 1-1	

All items in mm.

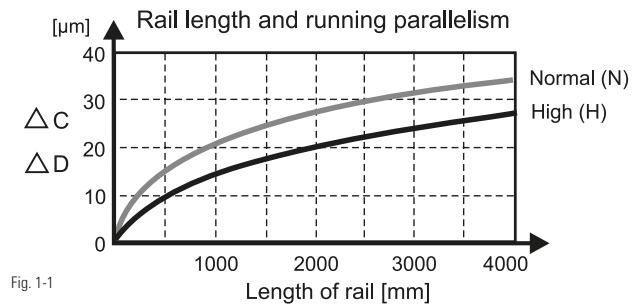
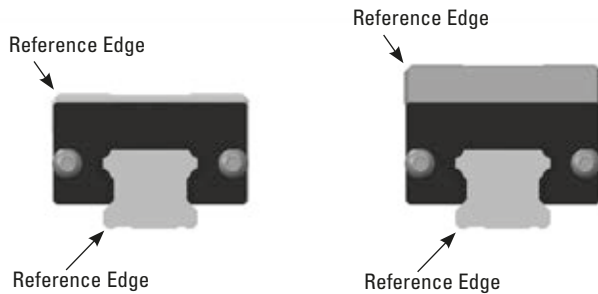
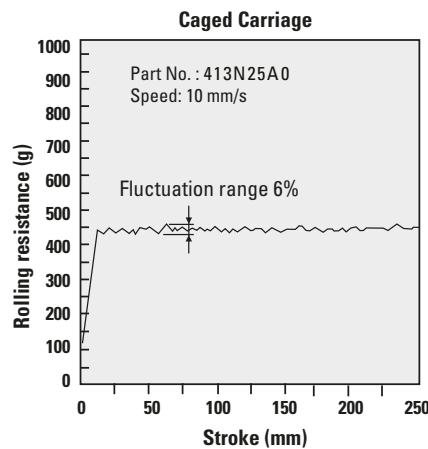
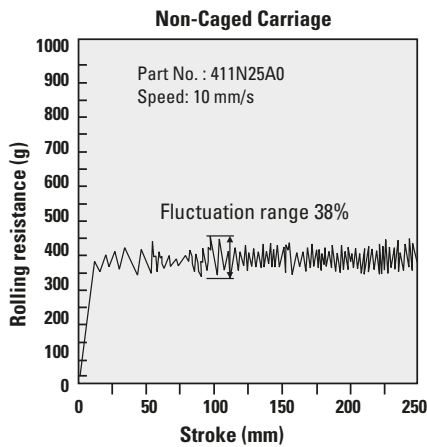

Fig. 1-1

## 413 Caged Ball Carriage Increased Running Smoothness



## 400 Series - Carriage Dowel Holes

Dowel holes are commonly used to ensure proper alignment during installation and replacement of carriages and rails. The standard press fit dowel hole options for the 400 series Standard Ball Carriages are:

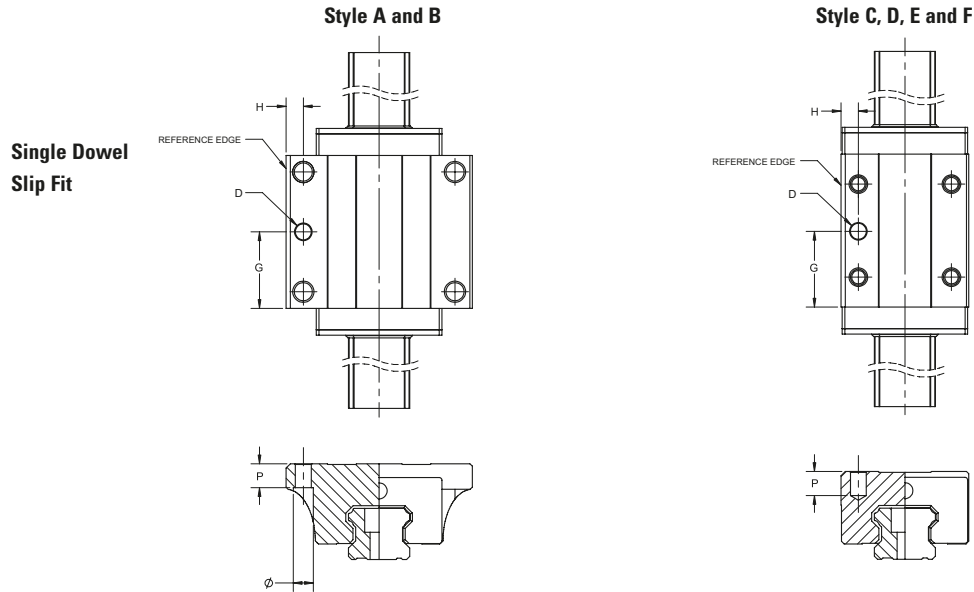

400		G	ØD	ES1 H	P	ØD	ES2 H	P	ØD	ES3 H	P	ØD	ES4 H	P
Style	Size													
Type A	15	20.10	6	4.5	7	—	—	—	1/4"	4.5	7	—	—	—
	20	24.25	6	5	9	—	—	—	1/4"	5	9	—	—	—
	25	28.75	6	6.5	9	—	—	—	1/4"	6.5	9	—	—	—
	30	33.90	6	9	12	10	9	12	1/4"	9	12	3/8"	9	12
	35	40.25	—	—	—	10	9	14	—	—	—	3/8"	9	14
	45	47.00	—	—	—	10	10	18	—	—	—	3/8"	10	18
Type B	20	30.65	6	5	9	—	—	—	1/4"	5	9	—	—	—
	25	36.10	6	6.5	9	—	—	—	1/4"	6.5	9	—	—	—
	30	39.00	6	9	12	10	9	12	1/4"	9	12	3/8"	9	12
	35	46.25	—	—	—	10	9	14	—	—	—	3/8"	9	14
	45	55.00	—	—	—	10	10	18	—	—	—	3/8"	10	18
Type C	15	20.10	6	4	4.8	—	—	—	1/4"	4	4.8	—	—	—
	20	20.25	6	6	6.5	—	—	—	1/4"	6	6.5	—	—	—
	25	28.75	6	6.5	9	—	—	—	1/4"	6.5	9	—	—	—
	30	33.90	6	10	10	10	10	10	1/4"	10	10	3/8"	10	10
Type D	25	43.45	6	6.5	9	—	—	—	1/4"	6.5	9	—	—	—
	30	51.75	6	10	10	10	10	10	1/4"	10	10	3/8"	10	10
	35	61.25	—	—	—	10	10	10	—	—	—	3/8"	10	10
Type E	15	20.10	6	4	6	—	—	—	1/4"	4	6	—	—	—
	25	28.75	6	6.5	9	—	—	—	1/4"	6.5	9	—	—	—
	30	33.90	6	10	12	10	10	12	1/4"	10	12	3/8"	10	12
	35	40.25	—	—	—	10	10	12	—	—	—	3/8"	10	12
	45	47.00	—	—	—	10	13	18	—	—	—	3/8"	13	18
	55	47.00	—	—	—	10	13	18	—	—	—	3/8"	13	18
Type F	25	36.10	6	6.5	9	—	—	—	1/4"	6.5	9	—	—	—
	30	39.00	6	10	12	10	10	12	1/4"	10	12	3/8"	10	12
	35	46.25	—	—	—	10	10	12	—	—	—	3/8"	10	12
	45	55.00	—	—	—	10	13	18	—	—	—	3/8"	13	18
	55	55.00	—	—	—	10	13	18	—	—	—	3/8"	13	18

All dimension in mm, unless otherwise specified.

Hole tolerance  $\varnothing D +0.013/-0$



### 400 Series - Carriage Dowel Holes (continued)

Dowel holes are commonly used to ensure proper alignment during installation and replacement of carriages and rails. The standard slip fit dowel hole options for the 400 series Standard Ball Carriages are:

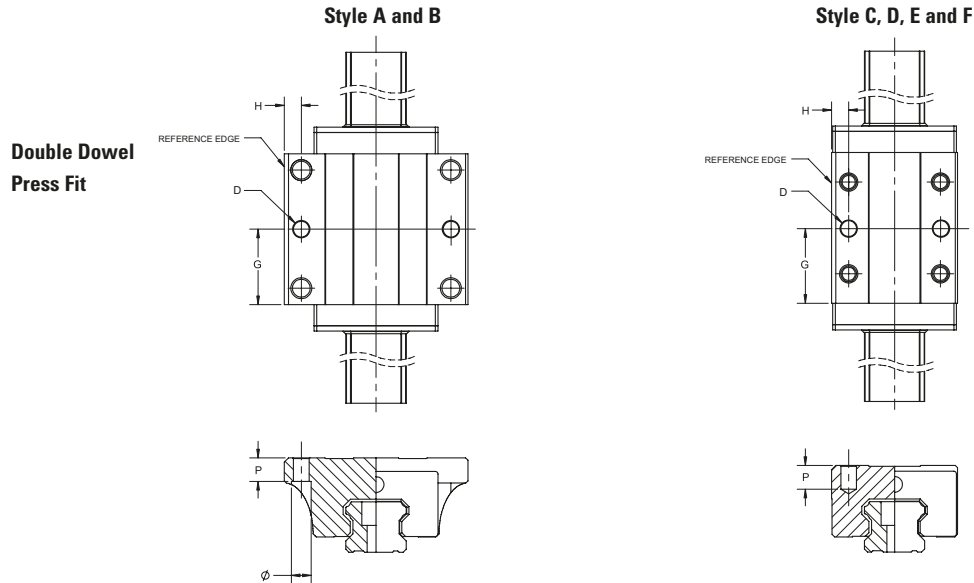

400 Series  
Profile Rail

400		G	ES12			ES13			ES14			ES15		
Style	Size		ØD	H	P	ØD	H	P	ØD	H	P	ØD	H	P
Type A	15	20.10	6	4.5	7	—	—	—	1/4"	4.5	7	—	—	—
	20	24.25	6	5	9	—	—	—	1/4"	5	9	—	—	—
	25	28.75	6	6.5	9	—	—	—	1/4"	6.5	9	—	—	—
	30	33.90	6	9	12	10	9	12	1/4"	9	12	3/8"	9	12
	35	40.25	—	—	—	10	9	14	—	—	—	3/8"	9	14
	45	47.00	—	—	—	10	10	18	—	—	—	3/8"	10	18
Type B	20	30.65	6	5	9	—	—	—	1/4"	5	9	—	—	—
	25	36.10	6	6.5	9	—	—	—	1/4"	6.5	9	—	—	—
	30	39.00	6	9	12	10	9	12	1/4"	9	12	3/8"	9	12
	35	46.25	—	—	—	10	9	14	—	—	—	3/8"	9	14
	45	55.00	—	—	—	10	10	18	—	—	—	3/8"	10	18
	55	55.00	—	—	—	10	10	18	—	—	—	3/8"	10	18
Type C	15	20.10	6	4	4.8	—	—	—	1/4"	4	4.8	—	—	—
	20	20.25	6	6	6.5	—	—	—	1/4"	6	6.5	—	—	—
	25	28.75	6	6.5	9	—	—	—	1/4"	6.5	9	—	—	—
	30	33.90	6	10	10	10	10	10	1/4"	10	10	3/8"	10	10
Type D	25	43.45	6	6.5	9	—	—	—	1/4"	6.5	9	—	—	—
	30	51.75	6	10	10	10	10	10	1/4"	10	10	3/8"	10	10
	35	61.25	—	—	—	10	10	10	—	—	—	3/8"	10	10
Type E	15	20.10	6	4	6	—	—	—	1/4"	4	6	—	—	—
	25	28.75	6	6.5	9	—	—	—	1/4"	6.5	9	—	—	—
	30	33.90	6	10	12	10	10	12	1/4"	10	12	3/8"	10	12
	35	40.25	—	—	—	10	10	12	—	—	—	3/8"	10	12
	45	47.00	—	—	—	10	13	18	—	—	—	3/8"	13	18
	55	47.00	—	—	—	10	13	18	—	—	—	3/8"	13	18
Type F	25	36.10	6	6.5	9	—	—	—	1/4"	6.5	9	—	—	—
	30	39.00	6	10	12	10	10	12	1/4"	10	12	3/8"	10	12
	35	46.25	—	—	—	10	10	12	—	—	—	3/8"	10	12
	45	55.00	—	—	—	10	13	18	—	—	—	3/8"	13	18
	55	55.00	—	—	—	10	13	18	—	—	—	3/8"	13	18

All dimension in mm, unless otherwise specified.  
Hole tolerance  $\phi D +0/-0.013$

## 400 Series - Rail Length

### Maximum Length of One Piece Rail

Size (mm)	15	20	25	30	35	45	55
One Piece Rail Length	4000 mm						

### Extended Standard Rail Options

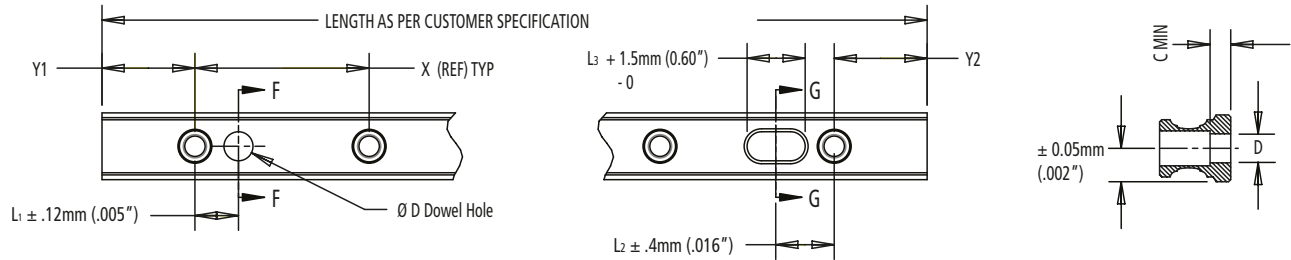

Option	D	L1	L2	L3	C
DH1	6mm	30mm	30mm	10.2 mm	9.5 mm
DH2	10mm	30mm	30mm	13.8 mm	9.5 mm
DH3	1/4"	1.181"	1.181"	.542"	3/8"
DH4	3/8"	1.181"	1.181"	.542"	3/8"

Y1 = Y2 unless specified at time of ordering

\*Size 25 and up step will be present around bottom of slot to control width tolerance during milling of slot.

The rail can be supplied with dowel holes, radial holes and coaxial holes to meet your application needs. Please provide a drawing of your requirement and our Application Engineering Team can provide a quote or select one of our extended standard options.

### Rail with Tapped Holes

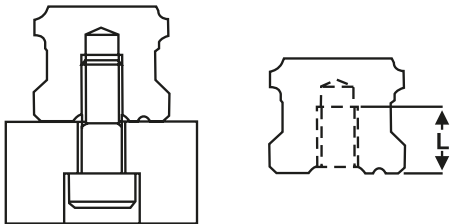

Bolting the rail from the underside allows for a clean top surface with no openings for debris and other particles to collect.

Size (mm)	15	20	25	30	35	45	55
Screw	M5	M6	M6	M8	M8	M12	M14
Length of thread	8 mm	10 mm	12 mm	15 mm	17 mm	24 mm	24 mm

### Thin Dense Chrome Plating

Rails and carriages are available with **Thin Dense Chrome Plating** with a thickness of 2–4 µm. It is only available in both High and Precision accuracy classes up to 4 meters long as a single rail; longer lengths require butt joints.

## 400 Series - Oil Fittings

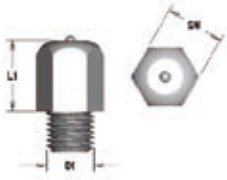

### 430LN15L3

Hydraulic-type lubricating nipple.

SW	D1	L1
5	M4x0.7xL3.5	6

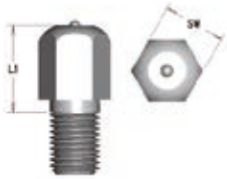

### 430LN15L-5

Hydraulic-type lubricating nipple.

Part No.	SW	D1	L1
430LN15L5	5	M4x0.7xL5	7
430LN15L	5	M4x0.7xL8	7



### 430LN20L / 15L7 / 15L12

Hydraulic-type lubricating nipple. Straight.

Part No.	SW	D1	L1
430LN20L		M6x1.0xL5	7.3
430LN15L7		M6x1.0xL7	7.3
430LN15L12		M6x1.0xL12	7.3

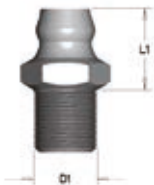

### 430LN35L / LNL

Hydraulic-type lubricating nipple. Straight.

Part No.	SW	D1	L1
430LN35L		M8x1.25xL8	10.2
430LNL		M8x1.25xL12	10.2

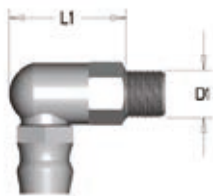

### 430LN90L5 / L7 / L12

Hydraulic-type lubricating nipple. 90° angle.

Part No.	SW	D1	L1
430LN90L5		M6x1.0xL5	14.7
430LN90L7		M6x1.0xL7	14.7
430LN90L12		M6x1.0xL12	14.7

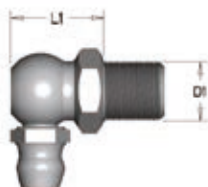

### 430LN95L8 / L12

Hydraulic-type lubricating nipple. 90° angle.

Part No.	SW	D1	L1
430LN95L8		M8x1.25xL8	12.5
430LN95L12		M8x1.25xL12	12.5

## 400 Series - Oil Fittings

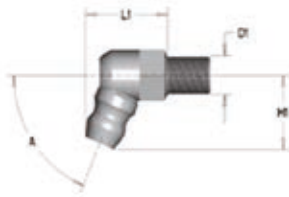

### 430LN45L5 / 45L7 / 45L

Hydraulic-type lubricating nipple. 67.5° angle.

Part No.	SW	D1	L1	H1	A
430LN45L5		M6x1.0xL5	13.5	11.4	67.5
430LN45L7		M6x1.0xL7	13.5	11.4	67.5
430LN45L		M6x1.0xL12	13.5	11.4	67.5

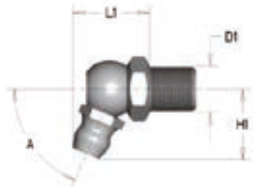

### 430LN55L8 / L

Hydraulic-type lubricating nipple. 67.5° angle.

Part No.	SW	D1	L1	H1	A
430LN55L8		M8x1.25xL8	13.3	12.3	67.5
430LN55L		M8x1.25xL12	13.3	12.3	67.5

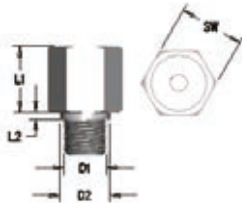

### 430LNS25L5 / L8 / L12

Hydraulic-type lubricating nipple. Straight.

Part No.	SW	D1	D2	L1	L2
430LNS25L5	9.2	M6x1.0xL5	7	9.4	1
430LNS25L8	9.2	M6x1.0xL7	7	9.4	1
430LNS25L12	9.2	M6x1.0xL12	7	9.4	1

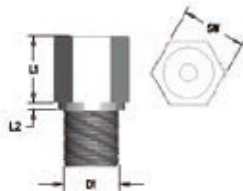

### 430LNS35L8 / L12

Hydraulic-type lubricating nipple. Straight.

Part No.	SW	D1	L1	H1	A
430LNS35L8	9.2	M8x1.25xL8	13.3	12.3	67.5
430LNS35L12	9.2	M8x1.25xL12	13.3	12.3	67.5

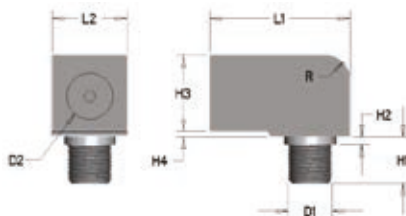

### 430LNA25L5 / L8 / L12

Hydraulic-type lubricating nipple. 90° angle block.

Part No.	D1	L1	L2	H1	H2	H3	H4	D2	R
430LNA25L5	M6x1.0xL5	18.2	9.2	6	1	9.8	.75	M8x1	3
430LNA25L8	M6x1.0xL7	18.2	9.2	8	1	9.8	.75	M8x1	3
430LNA25L12	M6x1.0xL12	18.2	9.2	13	1	9.8	.75	M8x1	3

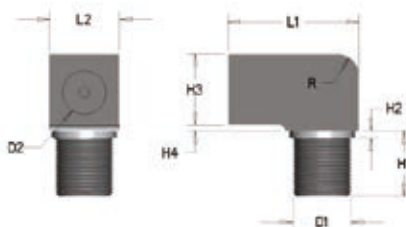

### 430LNA35L8 / L12

Hydraulic-type lubricating nipple. 90° angle block.

Part No.	D1	L1	L2	H1	H2	H3	H4	D2	R
430LNA35L8	M8x1.25xL8	18.2	9.2	9	1	9.8	.75	M8x1	3
430LNA35L12	M6x1.0xL12	18.2	9.2	13	1	9.8	.75	M8x1	3

## AccuMini Linear Ball Guides

Ultra compact, high roll moment capacity

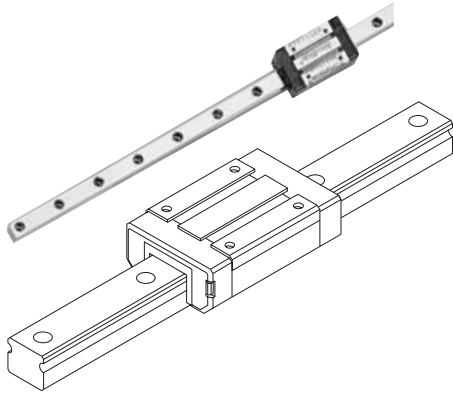

### Thomson AccuMini Linear Ball Guides offer:

- Advanced Ball Control - reduces friction to provide smooth, quiet operation at high speeds.
- Full Length Integral Wiper - protects critical components from contamination to maximize system life.
- Gothic Arch Profile - provides high roll moment capacity, critical for single rail designs.
- Engineered Polymer Retainer - reduces system inertia and noise.
- Stainless Steel Ball Bearings - resist corrosion from harsh environments.

### Part Number Description and Specification

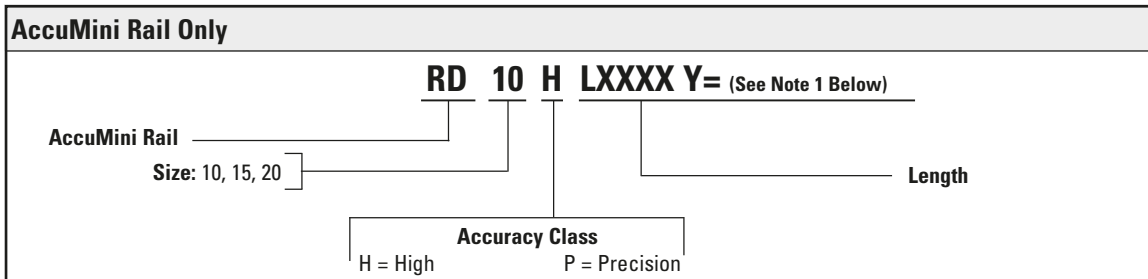
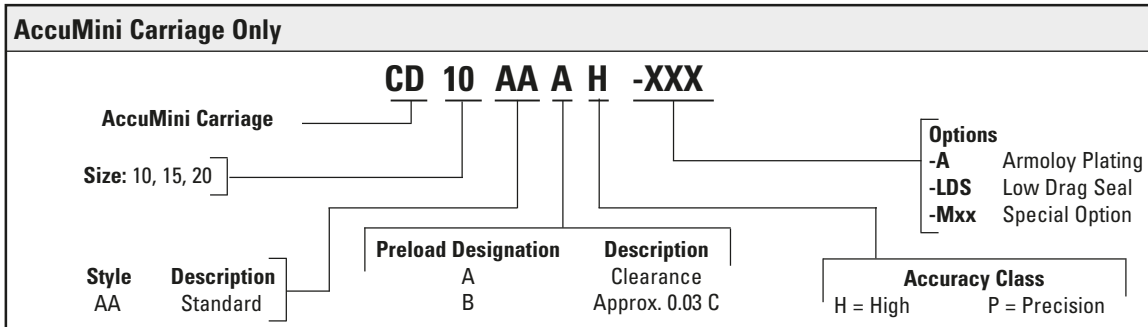
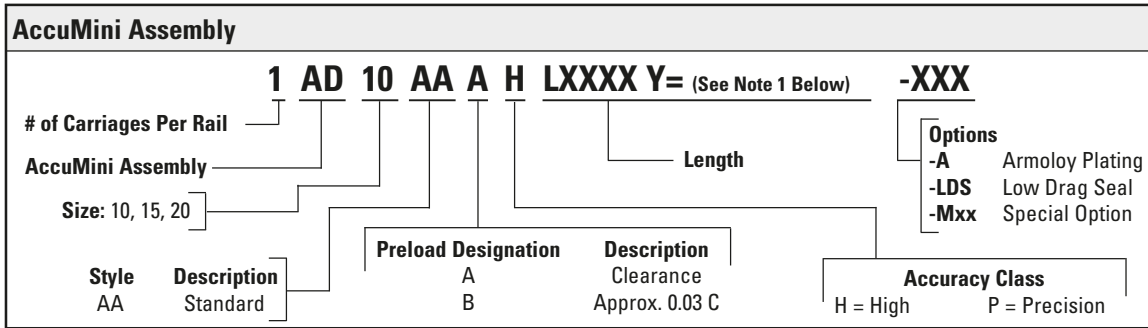

1. Y= Distance from end of rail to center of 1st mounting hole

## AccuMini

(Miniature Series)  
Low Profile, Compact Design

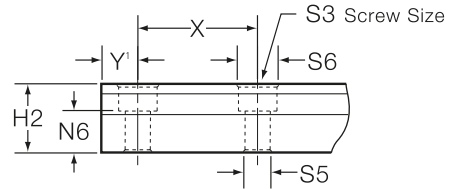
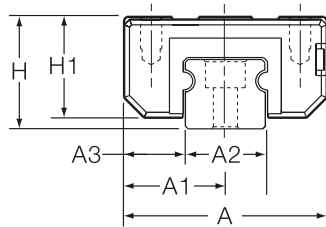

1. "Y" dimension will be equal on both ends unless specified by customer.

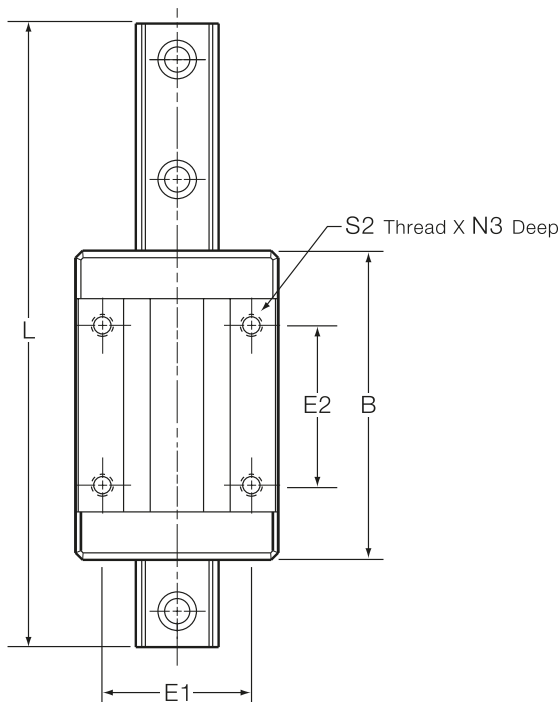

**NOTE:**

The AccuMini linear guide series carriages do not have retained balls. Removing the carriage from the rail without an arbor will result in the balls falling out.

### AccuMini Linear Guide Series

(mm)														
Size	A	A1	A2	A3	H	H1	H2	B	E1	E2	S2	S3	S5	S6
10	26	13	10	8	15	13	9	40	17	20	M2,5	M2,5	3	5,5
15	38	19	15	11,5	21	19	13	58	28	30	M4	M4	4,5	8
20	50	25	20	15	28	25,6	18	76	37	40	M5	M5	5,5	9,5

# AccuMini

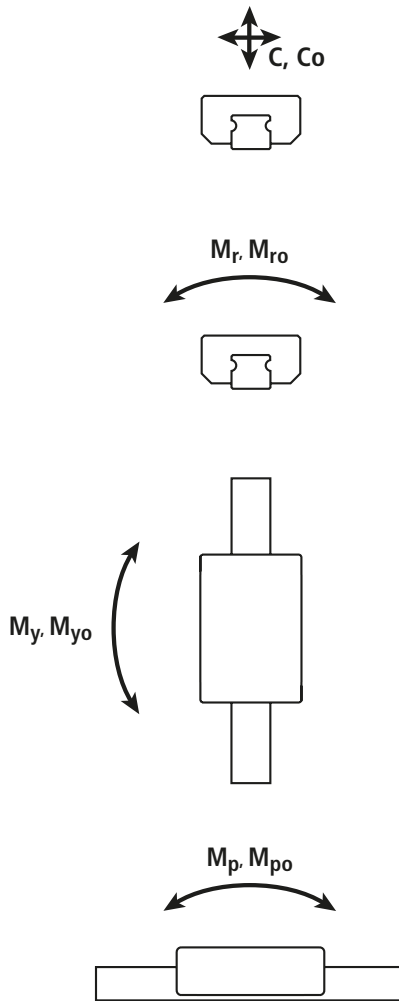

### Dynamic Load and Moment Ratings

- C** = Dynamic load rating
- M<sub>p</sub>** = Dynamic pitch moment rating
- M<sub>r</sub>** = Dynamic roll moment rating
- M<sub>y</sub>** = Dynamic yaw moment rating

The dynamic load and moment ratings are based upon a 100 km travel life. In order to compare with bearings rated for 50 km, divide the dynamic capacity of the bearing rated for 50 km by 1.26.

### Static Load and Moment Capacities

- C<sub>o</sub>** = Static load capacity
- M<sub>po</sub>** = Static pitch moment capacity
- M<sub>ro</sub>** = Static roll moment capacity
- M<sub>yo</sub>** = Static yaw moment capacity

The static load and moment capacities are the maximum radial load and moment load that should be applied to the bearing while there is no relative motion between the carriage and rail.

### Bearing Travel Life Comparison

$$L = (C/F)^3 \times 100 \text{ km}$$

where:

- L** = travel life, km
- C** = dynamic load rating, N
- F** = applied dynamic load, N

$$C_{\min} = F \left( \frac{L}{100} \right)^{1/3}$$

where:

- C<sub>min</sub>** = minimum required dynamic load rating, N
- F** = applied dynamic load, N
- L** = required travel life, km

### Operating Parameters

- Maximum Velocity = 3 m/s
- Maximum Acceleration = 50 m/s<sup>2</sup>
- Maximum Temperature = 80° C

AccuMini

## AccuMini Series

Size	(mm)				Load Rating	N (lbf)	Moment Rating				MASS Carriage Rail	
	N3	N6	X	L <sub>max</sub> ‡	C (@100 km)	C <sub>o</sub>	M <sub>p</sub> , M <sub>y</sub>	M <sub>po</sub> , M <sub>yo</sub>	M <sub>r</sub>	M <sub>ro</sub>	kg	kg/m
10	4,5	5,5	25	3000	2820 (635)	5300 1,190	10 (7)	20 (15)	15 (11)	28 (21)	0,045	0,65
15	6	7,5	40	3000	6375 (1,430)	15200 (3,420)	35 (26)	66 (49)	51 (38)	96 (71)	0,141	1,42
20	8	9,5	60	3000	11870 (2,670)	23000 (5,170)	75 (55)	140 (105)	125 (92)	235 (175)	0,345	2,55

‡ Maximum rail length in one section. Multiple sections can be butt jointed together for longer lengths.

## AccuMini

Three tolerances describe the accuracy of a Profile Rail bearing: Running Parallelism, Pair Variation, and Assembly Accuracy. These are measured from the rail base to the center of the carriage top (H), and from the rail reference edge to the center of the carriage reference edge (A3).

Running Parallelism describes the tolerance on H and A3 as a function of axial travel, measured from one carriage down the length of the rail. This is analogous to straightness of travel. As such, parallelism describes attributes of the rail only.

Assembly Accuracy describes the tolerance on H and A3 as a function of a carriage – rail assembly, measured from the nominal dimensions.

Pair Variation describes tolerance on H and A3 as a function of carriages at the same position on a common rail. Pair variation describes carriage precision only.

The accuracy class selected will partially determine the accuracy of the system. Other factors such as mounting surface flatness and straightness also significantly affect system accuracy.

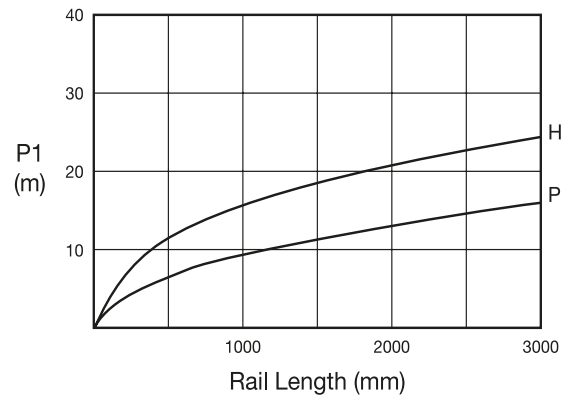
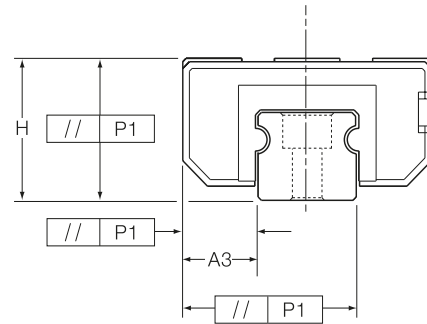

### Tolerances

	Accuracy Class	
	H - High	P - Precision
Assembly Accuracy Tolerance on dimension H and A3 (measured at middle of carriage at any point along rail)	±40	±20
Pair Variation Max variation in dimensions H and A3 measured on multiple carriages mounted on the same rail (measured at the middle of carriage at same position on rail)	15	7
Running Parallelism	See figures above.	

All values in  $\mu\text{m}$

### Preload Accuracy Combinations

Accuracy Class	Preload	
	Clearance up to 10 $\mu\text{m}$	Light approximately 0,03C <sup>1</sup>
P	–	B
H	A	B

1. C = Dynamic load capacity of the bearing.

### Calculations

To determine proper carriage size:

$$C_{\min} = F \cdot \left( \frac{L}{100} \right)^{1/3}$$

$C_{\min}$  = minimum required dynamic load capacity of carriage (N)

F = equivalent load on carriage (N)

L = required travel life (km)

To determine travel life:

$$L = \left( \frac{C}{F} \right)^3 \cdot 100$$

L = normal travel life (km)

C = rated dynamic load capacity of carriage (N)

F = equivalent load on carriage (N)

### Conversions

$$1 \text{ lb}_f = 4,448 \text{ N}$$

$$1 \text{ kg}_f = 9,8 \text{ N}$$

$$1 \text{ km} = 39,370 \text{ inches}$$

$$1 \text{ Nm} = 0.7376 \text{ lb}_f \cdot \text{ft}$$

### Operating Parameters

**Maximum Velocity** = 3 m/s

**Maximum Acceleration** = 50 m/s<sup>2</sup>

**Maximum Temperature** = 80° C



# MicroGuide™ Profile Rail

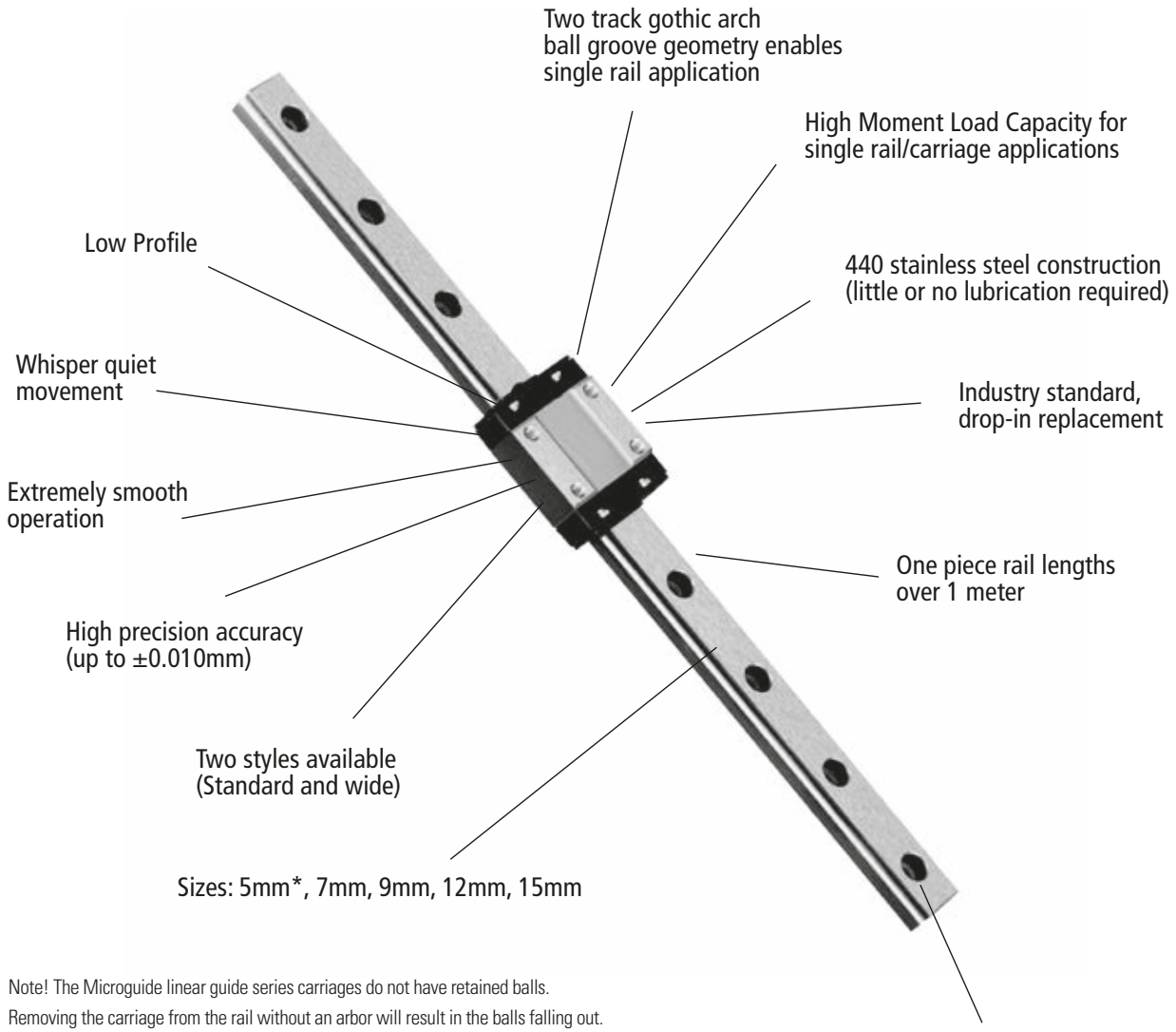

Note! The Microguide linear guide series carriages do not have retained balls. Removing the carriage from the rail without an arbor will result in the balls falling out.

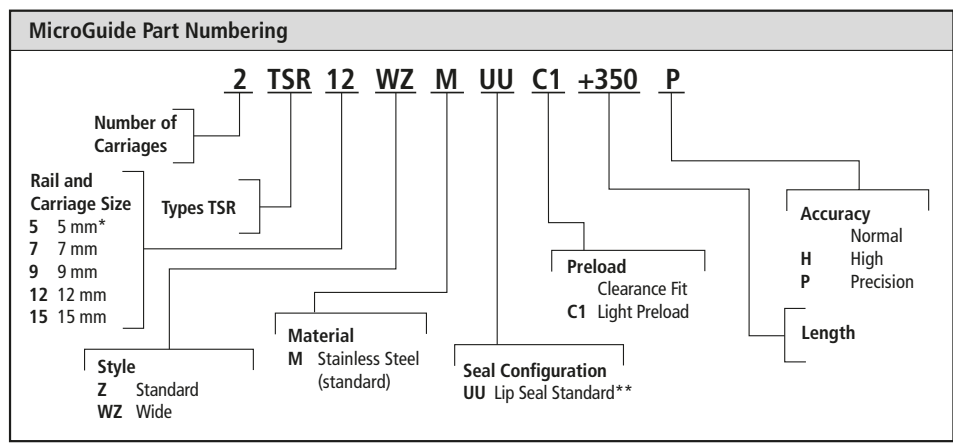

\*For 5 mm size, there are only 2 mounting holes per carriage.  
\*\*Seals are not available for 5 mm size.

MicroGuide

## MicroGuide™ Profile Rail

### TSR-Z Standard

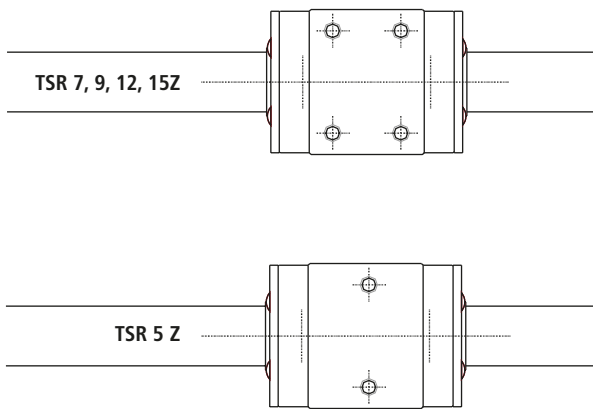
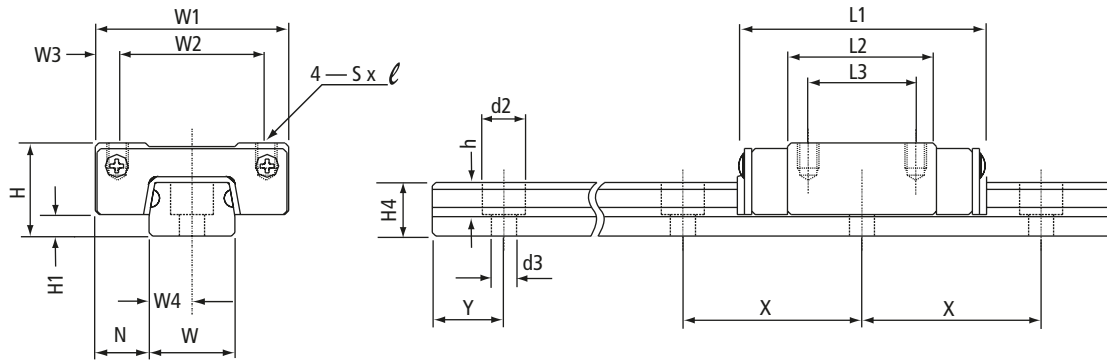

Standard Lengths of Rail

Sizes	5	7	9	12	15
Standard Lengths	40	40	55	70	150
	55	55	75	95	230
	70	70	95	120	310
	100	85	115	145	430
	130	100	135	170	550
	160	130	155	195	670
			175	220	1030
			195	245	
			275	270	
			1015	320	
			370		
			470		
			1020		
X	15	15	20	25	40
Y	5	5	7.5	10	15

Longer lengths may be supplied as single rail or butt joints. Please contact customer service for more information.

### MicroGuide™ TSR-Z (Standard)

Size	Assembly Dimensions			Carriage Dimensions							Rail Dimensions							
	H	H1	N	W1	W2	W3	L1	L2	L3	Sxℓ	W	W4	H4	d2	d3	h	Y	X
5	6	1.5	3.5	12	8	2	19	11	-	M2X1.5 <sup>(1)</sup>	5	2.5	4	3.5	2.4	1	5	15
7	8	1.5	5	17	12	2.5	23.5	13.5	8	M2X2.5	7	3.5	4.7	4.2	2.4	2.3	5	15
9	10	2.2	5.5	20	15	2.5	31	20.0	10	M3X3	9	4.5	5.5	6	3.5	3.3	7.5	20
12	13	3	7.5	27	20	3.5	35	20.8	15	M3X3.5	12	6	7.5	6	3.5	4.5	10	25
15	16	4	8.5	32	25	3.5	43	25.7	20	M3X4	15	7.5	9.5	6	3.5	4.5	15	40

(1) For 5mm size, there are only 2 mounting holes per carriage.

Note All: Dimensions in mm except where noted otherwise. Longer lengths are available with butt joints on sizes 7-15. Sizes in between standards are available, Y dimensions will be the same unless specified at time of ordering.

# MicroGuide™ Profile Rail

## TSR-Z Standard

### Dynamic Load and Moment Ratings

C = Dynamic load rating

### Static Load and Moment Capacities

C<sub>0</sub> = Static load rating  
 M<sub>P0</sub> = Static pitch moment capacity  
 M<sub>Y0</sub> = Static yaw moment capacity  
 M<sub>R0</sub> = Static roll moment capacity

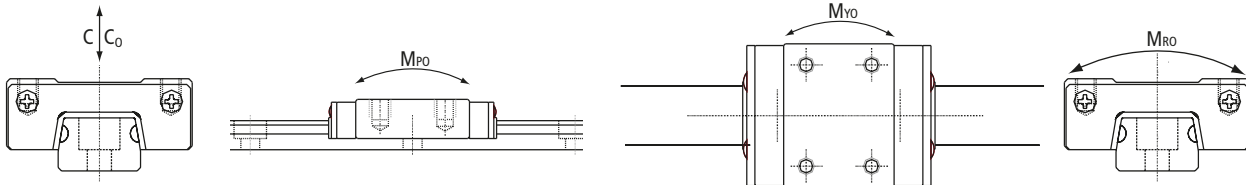

Size	Load Capacity (N)		Moments (Nm)			Mass	
	Dynamic C <sup>1</sup>	Limit C <sub>0</sub> <sup>2,3</sup>	M <sub>P0</sub>	M <sub>Y0</sub>	M <sub>R0</sub>	Carriage [kg]	Rail [kg/m]
5 <sup>4</sup>	336	620	0.8	0.8	1.47	0.01	0.14
7	924	1440	2.55	2.55	5.10	0.02	0.23
9	1544	2360	5.10	5.10	10.4	0.02	0.32
12	2780	4220	8.04	8.72	14.7	0.04	0.58
15	4410	6570	16.5	17.9	30.2	0.07	0.93

**Notes:**

1. The dynamic load and moment ratings are based upon 50km travel life.
2. The static load and moment capacities are the maximum radial load and moment load that should be applied to the bearing while there is no relative motion between the carriage and rail.
3. The load limit is the maximum load that may be applied to a system. It is important to analyze the application so that peak and/or shock loads do not exceed the load limit.
4. Size 5 does not have end seals. Pan head screws required to mount rail.

### Load/Life Calculations

<p>To determine proper carriage size:</p> $C_{min} = F \cdot \left(\frac{50}{L}\right)^{1/3}$ <p>C<sub>min</sub> = minimum required dynamic load capacity of carriage (N)</p> <p>F = equivalent load on carriage (N)</p> <p>L = required travel life (km)</p>	<p>To determine travel life:</p> $L = \left(\frac{C}{F}\right)^3 \cdot 50$ <p>L = normal travel life (km)</p> <p>C = rated dynamic load capacity of carriage (N)</p> <p>F = equivalent load on carriage (N)</p>
---	---

### Operating Parameters

Maximum Velocity: 3 m/s  
 Maximum Acceleration: 50 m/s

MicroGuide

## MicroGuide™ Profile Rail

### TSR-WZ Wide

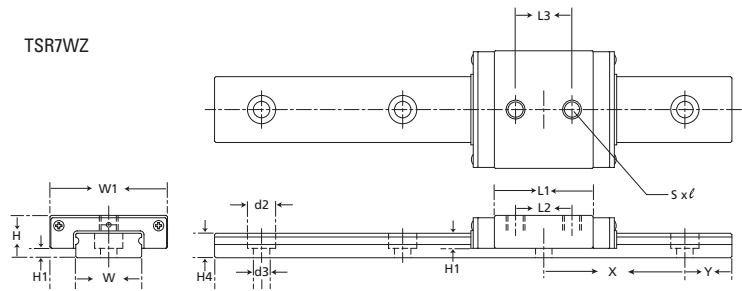
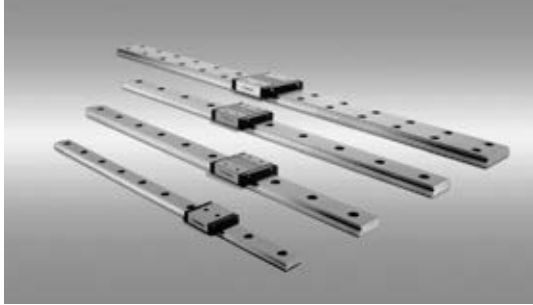

TSR9&12WZ

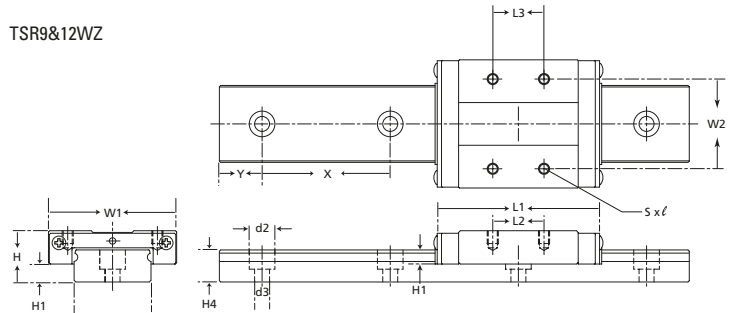

TSR15WZ

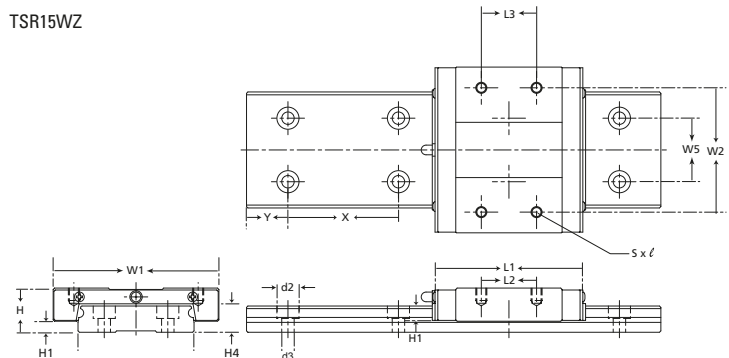

### Standard Lengths of Rail

Sizes	7	9	12	15
Standard Lengths	50	50	70	110
	85	110	150	190
	170	260	310	270
	100	350	390	430
	130	440	470	590
	260	530	630	750
	350	620	790	910
	440	800	950	1030
	530	1010	1030	
	620			
	800			
	1010			
	X	30	30	40
Y	10	10	15	15

### MicroGuide™ TSR-WZ Wide

Size	Assembly Dimensions			Carriage Dimensions						Rail Dimensions							
	H	H1	N	W1	W2	L1	L2	L3	Sxℓ	W	W5	H4	d2	d3	h	Y	X
7*	9	2	5.5	25	-	31	21.5	12	M4X3.5	14	-	5.2	6	3.5	3.2	10	30
9	12	4.2	6	30	21	39	28	12	M2.6X3	18	-	7.5	6	3.5	4.5	10	30
12	14	4	8	40	28	44.5	30.5	15	M3X3.5	24	-	8.5	8	4.5	4.5	15	40
15	16	4	9	60	45	55.5	38.5	20	M4X4.5	42	23	9.5	8	4.5	4.5	15	40

Note: All dimensions in mm except where noted otherwise. Longer lengths are available with butt joints.  
 Sizes in between standards are available, Y dimensions will be the same unless specified at time of ordering.

\* For 7 mm size, there are only 2 mounting holes per carriage.

# MicroGuide™ Profile Rail

## TSR-WZ Wide

### Dynamic Load and Moment Ratings

C = Dynamic load rating

### Static Load and Moment Capacities

C<sub>0</sub> = Static load rating  
 M<sub>PO</sub> = Static pitch moment capacity  
 M<sub>YO</sub> = Static yaw moment capacity  
 M<sub>RO</sub> = Static roll moment capacity

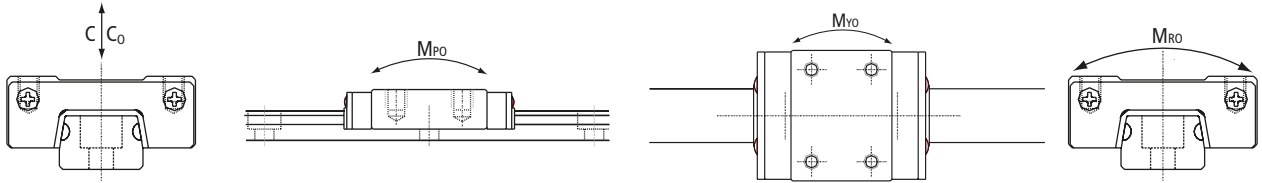

Size	Load Capacity (N)		Moments (Nm)			Mass	
	Dynamic C <sup>1</sup>	Limit Co <sup>2,3</sup>	M <sub>PO</sub>	M <sub>YO</sub>	M <sub>RO</sub>	Carriage [kg]	Rail [kg/m]
7	1370	2160	5.39	5.39	15.2	0.03	0.51
9	2450	3920	16.3	16.3	36.0	0.04	1.08
12	4020	6080	17.2	18.6	47.6	0.08	1.5
15	6660	9800	35.2	38.2	137	0.17	3.0

**Notes:**

- The dynamic load and moment ratings are based upon 50 km travel life.
- The static load and moment capacities are the maximum radial load and moment load that should be applied to the bearing while there is no relative motion between the carriage and rail.
- The load limit is the maximum load that may be applied to a system. It is important to analyze the application so that peak and/or shock loads do not exceed the load limit.

### Load/Life Calculations

<p>To determine proper carriage size:</p> $C_{min} = F \cdot \left(\frac{50}{L}\right)^{1/3}$ <p>C<sub>min</sub> = minimum required dynamic load capacity of carriage (N)</p> <p>F = equivalent load on carriage (N)</p> <p>L = required travel life (km)</p>	<p>To determine travel life:</p> $L = \left(\frac{C}{F}\right)^3 \cdot 50$ <p>L = normal travel life (km)</p> <p>C = rated dynamic load capacity of carriage (N)</p> <p>F = equivalent load on carriage (N)</p>
---	---

### Operating Parameters

Maximum Velocity: 3 m/s  
 Maximum Acceleration: 50 m/s<sup>2</sup>

MicroGuide

## MicroGuide™ Profile Rail

### TSR-Z (Standard) Accuracy Tolerance

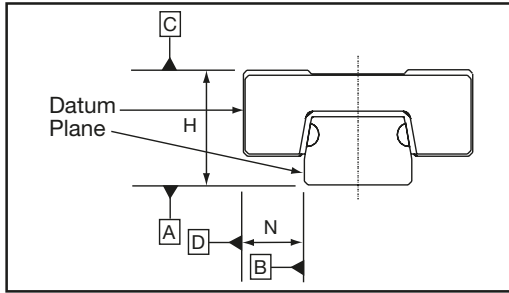

Accuracy of each part		TSR5 Z		TSR7 Z, TSR9 Z, TSR12 Z & TSR15 Z		
		Normal (blank)	Precision P	Normal (blank)	High H	Precision P
Height H	Dimensional Tolerance	±0.030	±0.015	±0.040	±0.020	±0.010
	Pair Tolerance	0.015	0.005	0.030	0.015	0.007
Width N	Dimensional Tolerance	±0.030	±0.015	±0.040	±0.025	±0.015
	Pair Tolerance	0.015	0.005	0.030	0.020	0.010

### TSR-Z (Standard) Running Parallelism

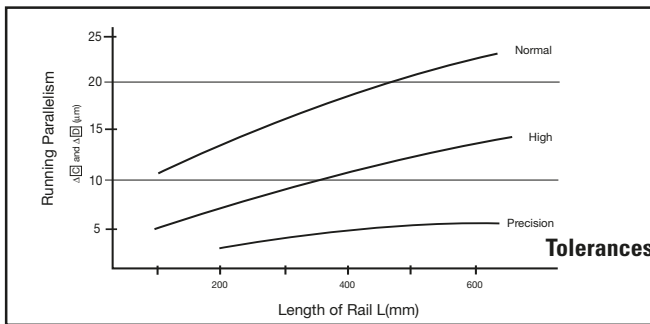

### TSR-Z (Standard) Fit Up

Series Type, Size and Style	Radial Clearances (µm)	
	clearance fit (blank)	light preload C1
TSR5 Z	0~+1.5	-1.5~0
TSR7 Z	±2	-3~0
TSR9 Z	±2	-4~0
TSR12 Z	±3	-6~0
TSR15 Z	±5	-10~0

### TSR-WZ (Wide) Accuracy Tolerance

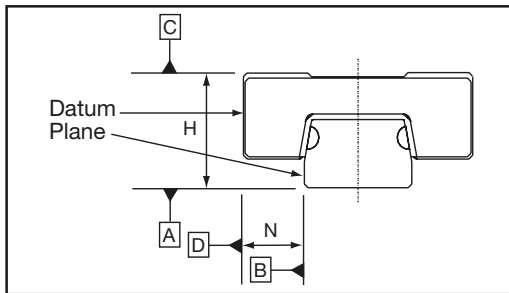

Accuracy of each part		TSR WZ		
		Normal (blank)	High H	Precision P
Height H	Dimensional Tolerance	±0.040	±0.020	±0.010
	Pair Tolerance	0.030	0.015	0.007
Width N	Dimensional Tolerance	±0.040	±0.025	±0.015
	Pair Tolerance	0.030	0.020	0.010

### TSR-WZ (Wide) Running Parallelism

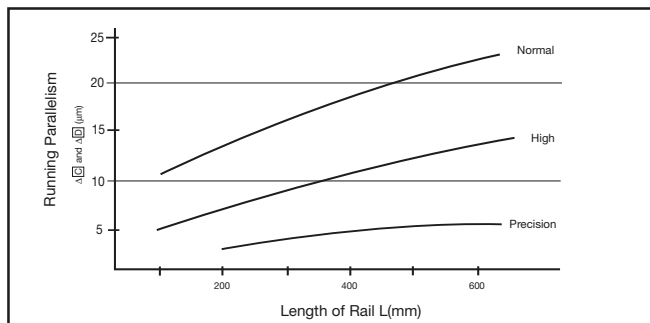

### TSR-WZ (Wide) Fit Up

Series Type, Size and Style	Radial Clearances (µm)	
	clearance fit (blank)	light preload C1
TSR7 WZ	±2	-3~0
TSR9 WZ	±2	-4~0
TSR12 WZ	±3	-6~0
TSR15 WZ	±5	-10~0

# MicroGuide™ Profile Rail

## Standard Lengths of Rail

Sizes	7 WZ	9 WZ	12 WZ	15 WZ
Standard Lengths	50	50	70	110
	110	110	150	190
	170	170	230	270
	260	260	310	430
	350	350	390	590
	440	440	470	750
	530	530	630	910
	620	620	790	1030
	800	800	950	
	1010	1010	1030	
X	30	30	40	40
Y	10	10	15	15



## Load/Life Calculations

To determine proper carriage size: $C_{min} = F \cdot \left(\frac{50}{L}\right)^{1/3}$ $C_{min}$ = minimum required dynamic load capacity of carriage (N) $F$ = equivalent load on carriage (N) $L$ = required travel life (km)	To determine travel life: $L = \left(\frac{C}{F}\right)^3 \cdot 50$ $L$ = normal travel life (km) $C$ = rated dynamic load capacity of carriage (N) $F$ = equivalent load on carriage (N)
---	---

## Conversions

<b>1 lbf</b> = 4.448 N	<b>1 km</b> = 39,370 inches
<b>1 kgf</b> = 9.8 N	<b>1 Nm</b> = 0.7376 lbf - ft

**Maximum Travel Speed:**  $V_{max} = 3 \text{ m/s}$   
**Maximum Acceleration:**  $a_{max} = 50 \text{ m/s}^2$

## How To Order

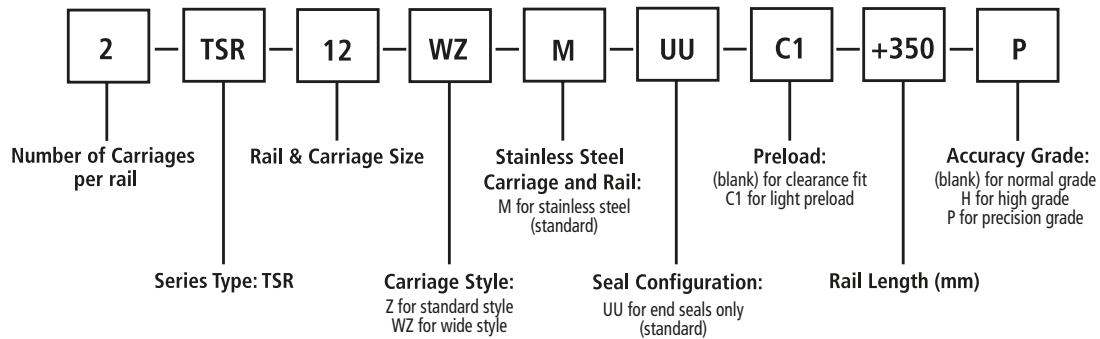

MicroGuide

**NOTES:**

A large grid of graph paper, consisting of 30 columns and 40 rows of small squares, intended for taking notes.



# T-Series Profile Rail

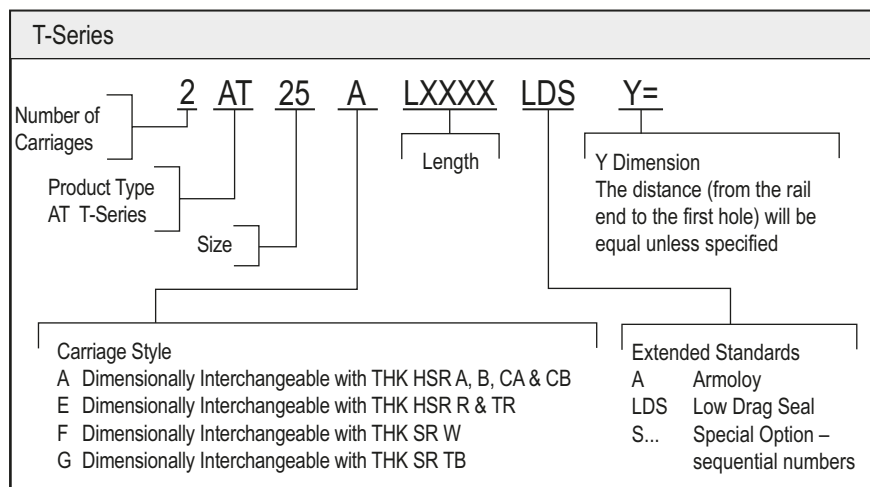
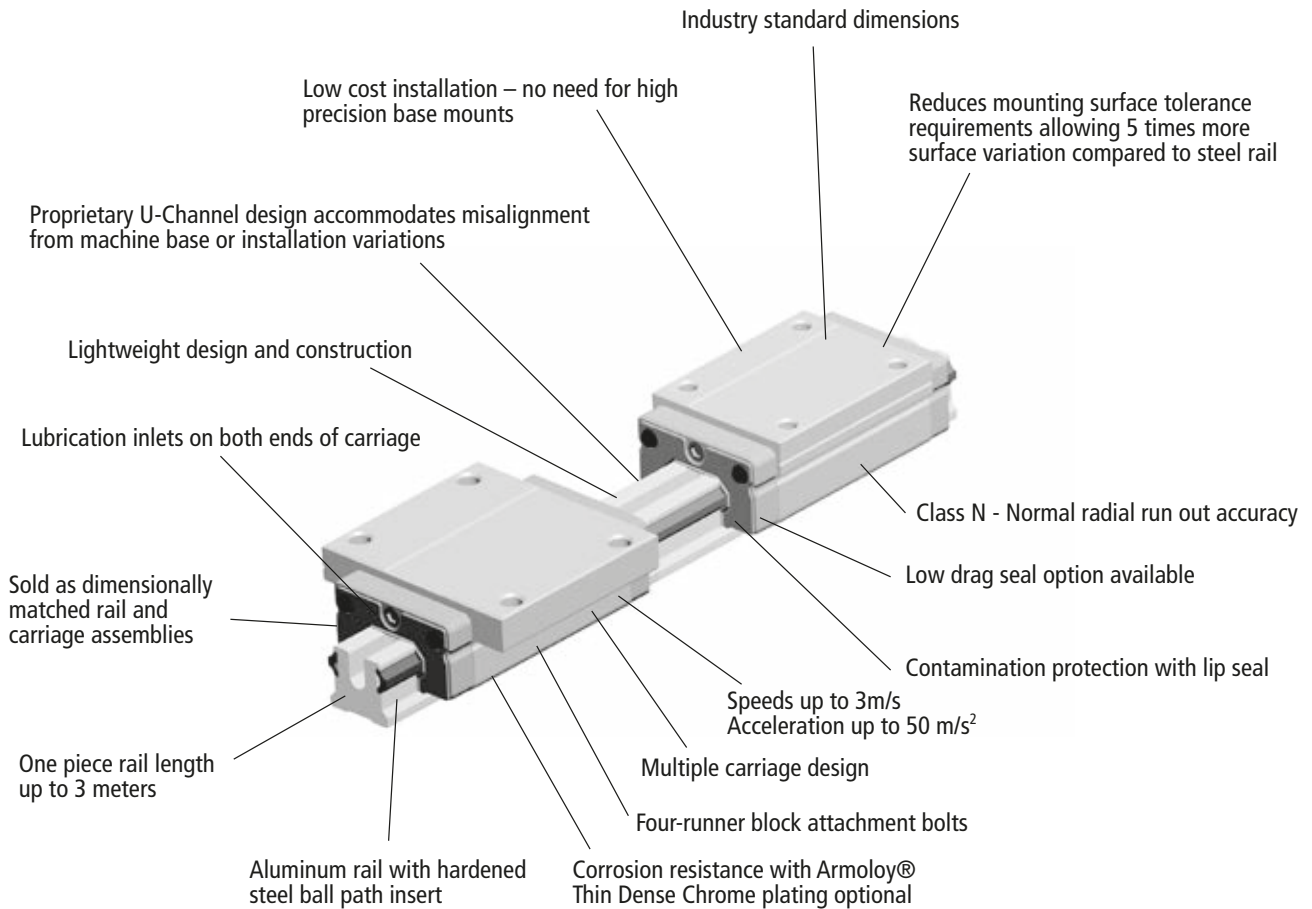

Note: 1. Sold as assemblies only  
2. Carriages are dimensionally matched to rails during assembly

## T-Series Ball Profile Rail

### Features

The Thomson T-Series Ball Profile Rail is lightweight, highly flexible and forgiving — an ideal choice for systems with low tolerance mounting surfaces.

### Materials

The Thomson T-Series Ball Profile Rail carriage and rail is produced from high quality aircraft aluminum alloy. The carriage has hardened steel load bearing plates. The rail has a custom ball path insert made of hardened steel. Stringent quality controls are in place to ensure consistency of steel from the source, allowing Thomson to deliver the highest quality product.

### Lightweight

The aluminum carriage and rail dramatically reduce the total weight of the assembly making Thomson T-Series an ideal choice for applications requiring reduced weight or inertia such as airplanes, ships, automobiles, etc.

### Accuracy

As a result of its high tolerance for alignment errors, the T-Series Ball Profile Rail is available in an N class radial run out only.

### Easy Installation

The Thomson T-Series can be mounted direct to non-machined bases without sacrificing total operational efficiency or the need for special tools or gauges to ensure proper rail and base straightness. By eliminating the costly machined base and special tools the installation time or machine build time can be cut in half, saving valuable time and money.

### Drop-in Replacement

The Thomson T-Series is designed to industry standard dimensions and rail hole patterns. This means it can be used as a drop-in replacement for any conventional all steel profile linear guide in the market today.

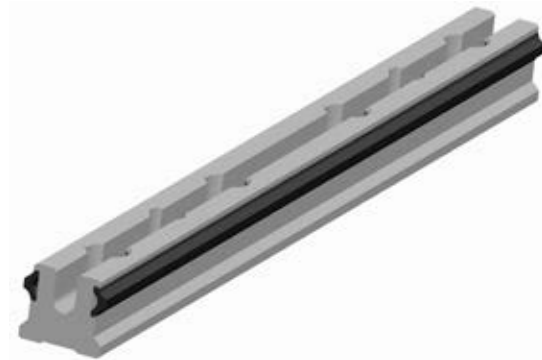
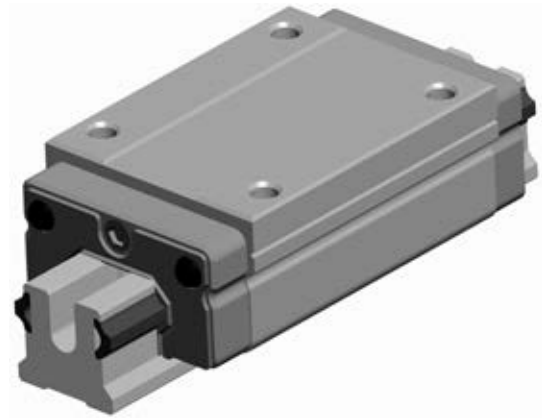

## T-Series Carriage Styles

**Standard Carriage Style A**  
 Sizes 20, 25, 35  
 Dimensionally interchangeable to THK  
 HSR A, B, CA, CB and Thomson 511 A

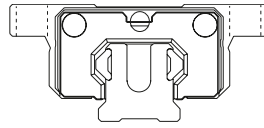

**Standard Short Hole Spacing Style G**  
 Sizes 20, 25, 35  
 Dimensionally interchangeable to THK SR TB

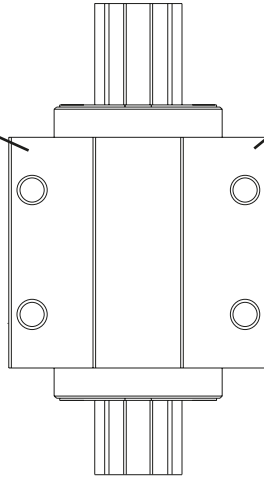

**Narrow Carriage Style E**  
 Sizes 20, 25, 35  
 Dimensionally interchangeable to THK  
 HSR R and TR and Thomson 511 E

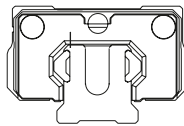

**Narrow High Style F**  
 Sizes 20, 25, 35  
 Dimensionally interchangeable  
 to THK SR W

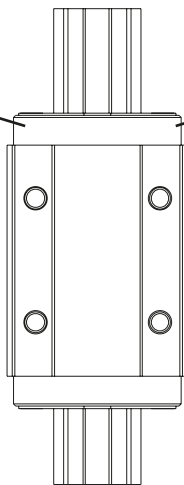

## T-Series Ball Profile Rail Style A and G

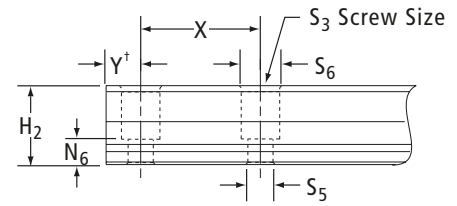
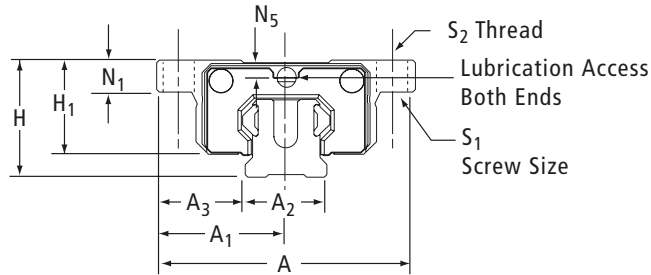

†- Will be equal on both ends, unless otherwise specified.

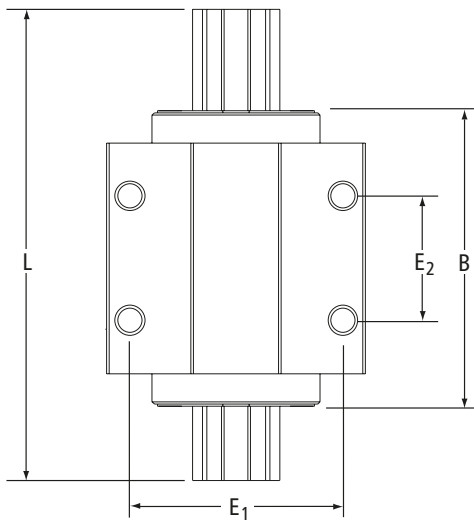

### Supplied Lubrication Fittings

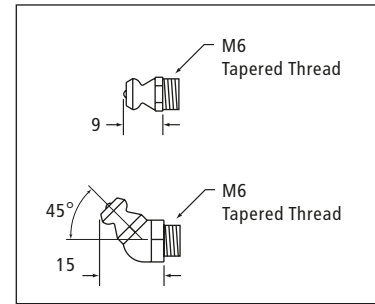

### T-Series Profile Rail Standard High "A" Style

Size	A	A1	A2	A3	H	H1	H2	B	E1	E2	S1	S2	S3	S5	S6	N1	N5	N6	X	L <sub>max</sub>
20	63	31.5	20	21.5	30	25	18	76	53	40	M5	M6	M5	5.8	9.5	10	6.25	7.5	60	3000
25	70	35	23	23.5	36	29.5	22	88	57	45	M6	M8	M6	7	10.7	12	8	10	60	3000
35	100	50	34	33	48	40	29	117	82	62	M8	M10	M8	9	14	15.26	6.6	11	80	3000

All dimensions in mm unless shown otherwise

### T-Series Profile Rail Standard "G" Style

Size	A	A1	A2	A3	H	H1	H2	B	E1	E2	S1	S2	S3	S5	S6	N1	N5	N6	X	L <sub>max</sub>
20	59	29.5	20	19.5	28	23	18	76	49	32	M5	M6	M5	5.8	9.5	8	4.25	7.5	60	3000
25	73	36.5	23	25	33	26.5	22	88	60	35	M6	M8	M6	7	10.7	9	5	10	60	3000
35	100	50	34	33	48	40	29	117	82	50	M8	M10	M8	9	14	15.26	6.6	11	80	3000

## T-Series Ball Profile Rail Style A and G

### Dynamic Load Rating

C = Dynamic load rating

The dynamic load rating is based upon a 100 km travel life. In order to compare with bearings rated for 50 km, divide the dynamic rating of the bearing rated for 50 km by 1.26.

### Static Load Capacity

C<sub>0</sub> = Static load capacity

The static load capacity is the maximum radial load that should be applied to the bearing while there is no relative motion between the carriage and rail.

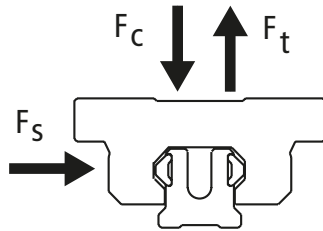

Size	Style	Load Ratings N (lbf)		Mass Carriage kg	Rail kg/m
		C (@100km)	C <sub>0</sub>		
20	A G	9000 (2025)	11000 (2475)	0.22	0.79
25	A G	13000 (2925)	15000 (3375)	0.30	1.06
35	A G	25000 (5620)	28000 (6295)	0.74	2.27

	Dynamic Load Rating	Load Limit
F <sub>c</sub>	C	C
F <sub>t</sub>	C	0.6C
F <sub>s</sub>	C	0.6C

### Bearing Travel Life Calculation

$$L = (C/F)^3 \times 100 \text{ km}$$

where:

L = travel life, km

C = dynamic load rating, N

F = applied dynamic load, N

### Operating Parameters

Maximum Velocity = 3 m/s

Maximum Acceleration = 50 m/s<sup>2</sup>

Maximum Temperature = 80°C

## T-Series Ball Profile Rail Style E and F

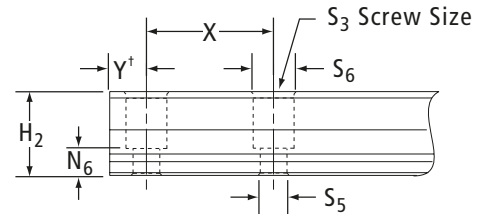
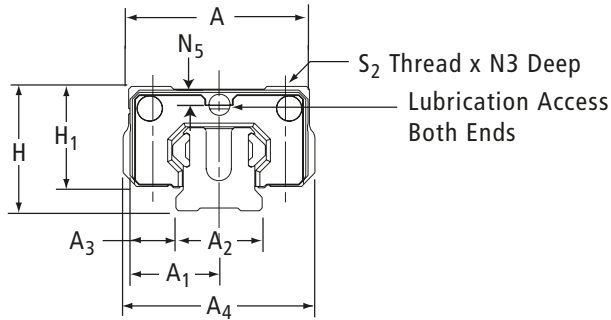

† - Will be equal on both ends, unless otherwise specified.

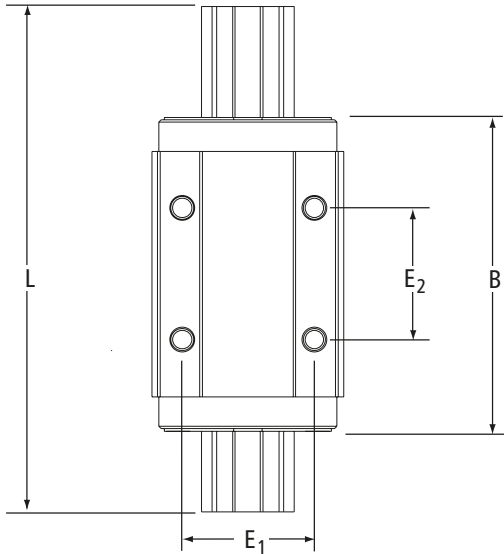

### Supplied Lubrication Fittings

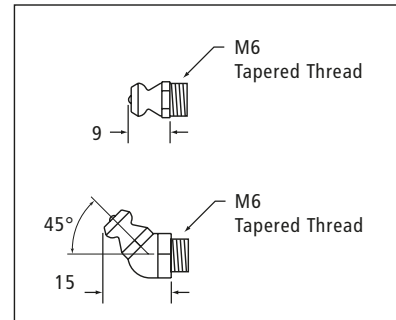

### T-Series Profile Rail Narrow "E" Style

Size	A	A1	A2	A3	A4	H	H1	H2	B	E1	E2	S2	S3	S5	S6	N3	N5	N6	X	L <sub>max</sub>
20	44	22	20	12	41.5	30	25	18	76	32	36	M5	M5	5.8	9.5	6	6.25	7.5	60	3000
25	48	24	23	12.5	50.9	40	33.5	22	88	35	35	M6	M6	7	10.7	8	12	10	60	3000
35	70	35	34	18	68.0	55	47	29	117	50	50	M8	M8	9	14	12	13.6	11	80	3000

All dimensions in mm unless shown otherwise

### T-Series Profile Rail Narrow High "F" Style

Size	A	A1	A2	A3	A4	H	H1	H2	B	E1	E2	S2	S3	S5	S6	N3	N5	N6	X	L <sub>max</sub>
20	42	21	20	11	41.5	28	23	18	76	32	32	M5	M5	5.8	9.5	6	4.25	7.5	60	3000
25	48	24	23	12.5	51.0	33	26.5	22	88	35	35	M6	M6	7	10.7	8	5	10	60	3000
35	70	35	34	18	68.0	48	40	29	117	50	50	M8	M8	9	14	12	6.6	11	80	3000

All dimensions in mm unless shown otherwise

## T-Series Ball Profile Rail Style E and F

### Dynamic Load Rating

C = Dynamic load rating

The dynamic load rating is based upon a 100 km travel life. In order to compare with bearings rated for 50 km, divide the dynamic rating of the bearing rated for 50 km by 1.26.

### Static Load Capacity

C<sub>0</sub> = Static load capacity

The static load capacity is the maximum radial load that should be applied to the bearing while there is no relative motion between the carriage and rail.

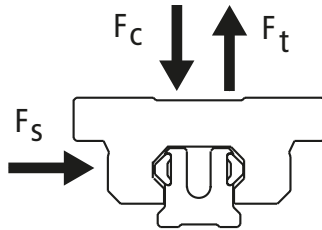

Size	Style	Load Ratings N (lbf)		Mass	
		C (@100km)	C <sub>0</sub>	Carriage kg	Rail kg/m
20	E F	9000 (2025)	11000 (2475)	0.22	0.79
25	E F	13000 (2925)	15000 (3375)	0.30	1.06
35	E F	25000 (5620)	28000 (6295)	0.74	2.27

	Dynamic Load Rating	Load Limit
F <sub>c</sub>	C	C
F <sub>t</sub>	C	0.6C
F <sub>s</sub>	C	0.6C

### Bearing Travel Life Calculation

$$L = (C/F)^3 \times 100 \text{ km}$$

where:

L = travel life, km

C = dynamic load rating, N

F = applied dynamic load, N

### Operating Parameters

Maximum Velocity = 3 m/s

Maximum Acceleration = 50 m/s<sup>2</sup>

Maximum Temperature = 80°C

## Installation Guidelines

**Figure 1**

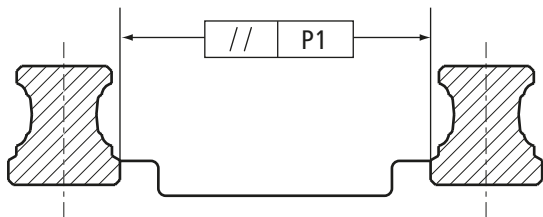

**Table 1. Parallelism Between Multiple Rails, mm**

Bearing Type	Clearance	Preload		
		0,03 C <sup>†</sup>	0,08 C <sup>†</sup>	0,13 C <sup>†</sup>
500 Series Ball Linear Guide				
15	.015	.010	.007	.003
20	.017	.012	.008	.004
25	.024	.016	.010	.005
30	.024	.016	.010	.005
35	.032	.021	.014	.008
45	.036	.024	.016	.009
500 Series Roller Linear Guide				
25	–	.016	.010	.005
35	–	.012	.014	.008
45	–	.024	.016	.009
55	–	.026	.017	.010
65	–	.028	.018	.011
AccuMini Linear Guide				
10	.009	.004	–	–
15	.011	.006	–	–
20	.013	.008	–	–
T-Series* Linear Guide				
15	.045	–	–	–
20	.045	–	–	–
25	.050	–	–	–
30	.055	–	–	–
35	.060	–	–	–
400 Series Ball Linear Guide				
15	.025	.018	–	–
20	.025	.020	–	–
25	.025	.020	–	–
30	.040	.030	–	–
35	.050	.035	–	–
45	.060	.040	–	–
55	.070	.050	–	–

<sup>†</sup> Where C = Dynamic Load Capacity

### Surface Preparation

ProfileRail bearings are generally mounted to structures that are inherently stiffer than the rail. For this reason, the bearings tend to assume the orientation of the surfaces to which they are fastened, through bearing deflection. When a deflection is imposed upon a bearing, especially a preloaded one, resultant forces occur. These forces are transferred to the rolling elements and races, potentially resulting in an increase in system friction and a decrease in system resolution, precision and life.

Various sources can contribute to the overall error of the mounting surfaces. These include the surface flatness of the base surfaces, the location and parallelism of the reference surfaces, and the attendant errors of the bearing as described within the accuracy classes.

The surfaces that contact the base and reference edges may be milled, scraped, ground, or prepared by any other method that will produce a flat mounting surface free of inconsistencies, which would tend to distort or skew the bearing. A simple stone may be used to remove high spots. Dirt and debris should be cleaned off, as they could contribute to the inaccuracies.

Associated with preload is a slight potential concavity of the carriage top surface. The preload is established when all the carriage screws are affixed to a planar surface, flattening the carriage base. Deviations affecting the planarity of the carriage mounting surface could result in a preload change.

### Mounting Tolerances

The tolerances found in Tables 1–3 are intended to provide an installation for which the associated derating is negligible. These specifications are based upon the assumption that the structures of the application are infinitely rigid and are of consideration for the bearing reactions only.

### Rail Parallelism (See Figure 1)

A variation in the distance between the rails will induce a shear or side load on the bearings.

In order to minimize the effect of this shear load, tolerances for rail reference edge parallelism may be found in Table 1.



## Installation Guidelines

Figure 2

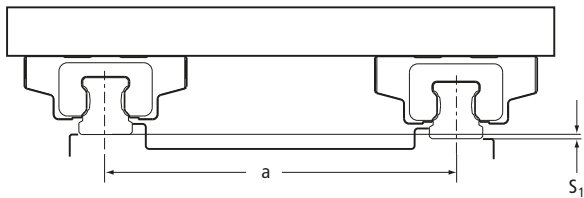

Table 2. Allowable Vertical Offsets Between Rails (S1/a), inch

Bearing Type	Preload			
	Clearance	0.03 C <sup>†</sup>	0.08 C <sup>†</sup>	0.13 C <sup>†</sup>
500 Series Ball	0.0006	0.0004	0.0003	0.0002
500 Series Roller	–	0.0007	0.0005	0.0004
AccuMini Linear Guide	0.0006	0.0004	–	–
T-Series Linear Guide	0.0020	–	–	–
400 Series 15, 20 & 25	0.0050	0.0030	–	–
400 Series 30	0.0060	0.0040	–	–
400 Series 35	0.0080	0.0050	–	–
400 Series 45	0.0090	0.0060	–	–
400 Series 55	0.0118	0.0080	–	–

<sup>†</sup>Where C=Dynamic Load Capacity

Figure 3

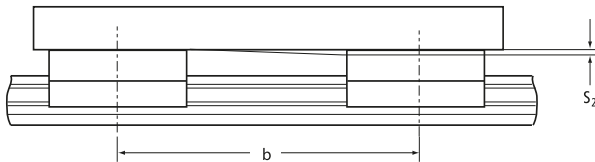

Figure 4

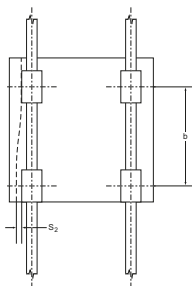

Table 3. Allowable Carriage Offsets (S2/b)

Bearing Type	Preload			
	Clearance	0.03 C <sup>†</sup>	0.08 C <sup>†</sup>	0.13 C <sup>†</sup>
500 Series (All)	0.00006	0.00005	0.00004	0.00003
400 Series 15 & 20	0.0009	0.0007	–	–
400 Series 25	0.0011	0.0008	–	–
400 Series 30	0.0015	0.0011	–	–
400 Series 35	0.0019	0.0013	–	–
400 Series 45	0.0023	0.0015	–	–
400 Series 55	0.0027	0.0017	–	–

<sup>†</sup>Where C=Dynamic Load Capacity

T-Series Linear Guide	0.00012
-----------------------	---------

### Rail Vertical Offset (See Figure 2)

A vertical offset of the rails across the axis will induce a roll moment onto the carriages.

To minimize the effect of this roll moment, tolerances for the vertical offset may be found in Table 2. This tolerance describes the attributes of the mounting surface, perpendicular to the rail axis.

### Vertical Carriage Offset (See Figure 3)

A vertical offset between fore and aft carriages will induce a pitch moment on the bearings.

### Lateral Carriage Offset (See Figure 4)

A lateral offset of the carriage reference edges will induce a yaw moment.

In order to minimize the effects of these pitch and yaw moments, tolerances may be found in Table 3. This tolerance describes the attributes of the mounting surface parallel to the rail axis, and the reference edge straightness.

**NOTE:** All mounting tolerances should be inclusive of the H and A3 tolerances. Thus, a lower accuracy class bearing may require a more accurate installation.

### Mounting Hole Tolerances

The positional tolerance between the through holes in the rails is 0.5 mm.

The positional tolerance of the first rail mounting hole dimensioned from the datum end (called the “Y-dimension”) is ±1.0 mm.

The overall rail length tolerance is ±2.0 mm.

The positional tolerance between the mounting holes in the carriages is 0.2 mm.

### Reference Edge Specifications

The maximum shoulder heights and corner radii are listed in Table 4.

## Installation Guidelines

**Table 4. Shoulder heights and corner radii, mm**

Guide Type	Rail		Carriage	
	h1 max	r1 max	h2	r2 max
500 Series Ball Linear Guide				
15	3.5	.8	3.5	.6
20	4	.9	4	.9
25	5	1.1	5	1.1
30	5.5	1.3	5.5	1.3
35	6	1.3	6	1.3
45	8	1.3	8	1.3
500 Series Roller Linear Guide				
25	5	.8	5	.8
35	6	.8	6	.8
45	8	.8	8	.8
55	10	1.2	10	1.2
65	10	1.5	10	1.5
AccuMini Linear Guide				
10	1.75	0.4	3.5	0.4
15	1.75	0.4	5	0.4
20	2	0.5	7	0.5
T-Series* Linear Guide				
15	3	.3	8	.2
20	3.9	0.4	10	0.3
25	5.5	0.5	12	0.4
30	5.9	0.7	14	0.5
35	5.9	0.8	15	0.6
400 Series Ball Linear Guide				
15	2.8	0.6	5	0.6
20	4.3	0.9	6	0.9
25	5.6	1.1	7	1.1
30	6.8	1.4	8	1.4
35	7.3	1.4	9	1.4
45	8.7	1.6	12	1.6
55	11.8	1.6	17	1.6

**Table 5. Recommended Bolt Tightening Torque, Nm**

Bolt Size	Class 8.8	Class 12.9
M2.5	0.7	1.2
M4	2.8	4.6
M5	5.7	9.5
M6	9.5	16
M8	23	39
M10	46	77
M12	80	135
M14	129	215
M16	198	330

### Installation Procedure

Clean and inspect all mating surfaces for burrs, nicks, dirt, etc. A simple stone can be used to remove minor imperfections in the mounting surfaces.

**Note:** T-Series is not as sensitive to imperfections of the mounting surface.

### Rail Mounting

- Carefully place the rail on the mounting surface.
- Insert screws into the mounting holes and tighten lightly.
- Clamp the reference edge of the rail against a locating edge on the mounting surface.

The locating edge can be a machined reference edge, a straight edge, a row of dowels or keys, or some other edge which the rail can be clamped against. It should be straight, either within the mounting tolerances shown in Table 3 or according to the application requirements, whichever is tighter.

- Starting from the center of the rail moving outwards, tighten each screw to the recommended tightening torque in Table 5.
- If parallel rails are to be used, one of the following methods may be employed to obtain the parallelism recommended in Table 1:
  - two parallel locating edges
  - a gage block or parallel between the rails
  - the use of the top plate with the carriages mounted, to locate or “float” the second rail into place.
- Repeat steps 1–4 to install the second rail.
- Insert a rail plug into each counterbore in the rail. Carefully tap rail plugs into place using a soft material such as brass or wood. When properly installed, the rail plugs should be flush with the top surface of the rail. Do not countersink the rail plugs.

**Note:** Rail plugs are available and are shipped with all rails except for the AccuMini Linear Guide size 10.

- If desired, rail tape can then be applied to the top of the rail. For sizes 35 and below, the rail tape may be used without the rail plugs.

## Installation Guidelines

**Figure 5. Shoulder Heights and Corner Radii**

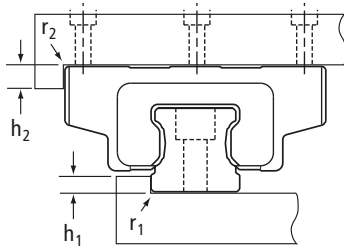

**Figure 6. Butt jointed rails**

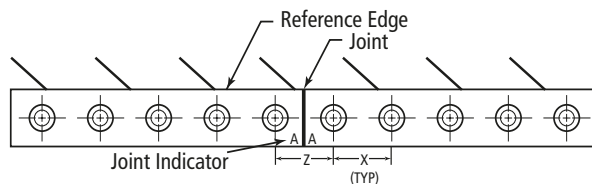

**Figure 7. Recommended Tightening Sequence**

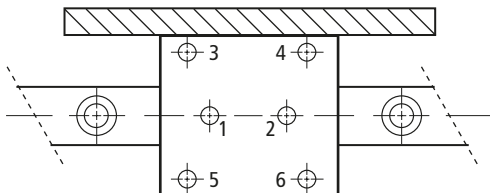

### Butt Joints

For rails longer than the longest length available in one piece, a butt joint is required. A butt joint is formed by butting the end of two matched rails together. The ends of rails to be butt jointed are specially machined and marked with same letter (A, B, C, etc.).

We strongly recommend the use of a locating edge when using butt jointed rails. This will ensure proper alignment of the raceways across the joint.

500 Series Ball, Roller and 400 Series linear guide rails, the mounting hole spacing across the joint, Z, will be equal to the standard mounting hole spacing, X.

Once mounted, a gap between the ends of the butt jointed rails of 0.5 mm or less is acceptable.

### Carriage Mounting

1. Carefully place the table top on the carriages.
2. Insert the screws into the mounting holes and tighten lightly.
3. Clamp the reference edge of the carriages to locating edges under the top plate.

**Note:** This is only required if the location of the center of the top plate is critical to the application, or if the top plate is being used to position a second rail parallel.

4. Tighten each screw to the recommended tightening torque in Table 5. For carriages with six mounting screws, the tightening sequence shown in Figure 7 is recommended.

5. Lubricate bearings.

**Note:** Extreme care should be taken when mounting the carriages to the rails. Forcing a carriage onto a rail can knock out rolling elements and/or damage the carriage and rail.

For large side forces, hard mounting is recommended to resist any translation. Some methods for hard mounting are the use of tapered gibs, retaining plates, or set screws in combination with machined reference edges. Other methods include the use of an epoxy/replicating material, dowels, and keys. Upon request, carriages and rails can be special machined to accommodate dowels or keys. Consult the factory for details.

## Profile Rail Engineering Guide

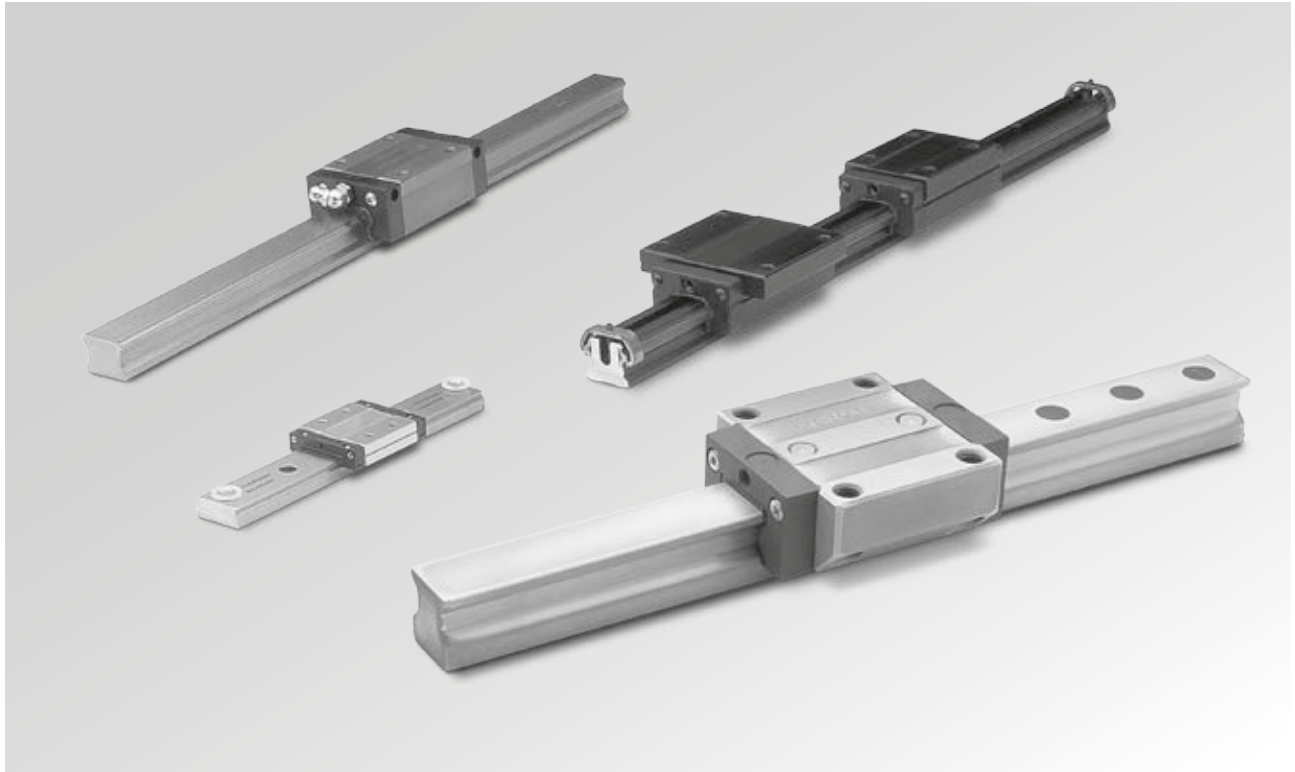

## Table of Contents

Description .....	Page
Profile Rail Selection .....	117
Technology Overview .....	117
Sizing & Defining Guide Characteristics .....	118
Applied Loading Calculations .....	119
Load Ratings: Rolling Element Guides Sliding Contact Guides .....	120
Preloading & Linear Guide Deflection .....	123
Actuation Force .....	144
Lubrication .....	146
Bellow Cover Length Calculations .....	148
Butt Joint Fax-back Worksheet .....	149
Conversion Table .....	150

## Profile Rail Selection

The selection of a linear guide can greatly affect machine performance and overall cost. In order to meet the wide variety of demands created by today's applications, proper selection from a broad range of linear guides is required.

For example, selecting a guide with too much rigidity will decrease the allowable installation tolerances, therefore, greatly increasing surface preparation costs. If the mounting surface is not prepared properly, the guide will run rough, and need to be replaced more frequently due to an unexpected reduction in travel life.

Consider all criteria appropriate for the application. Selection criteria include:

- Rigidity
- Travel accuracy
- Travel life
- Smoothness of travel
- Speed & Acceleration
- Envelope
- Environment
- Cost of Product
- Cost of Installation
- Cost of Replacement

Selection of the most appropriate type of guide, should be based on quantitative/qualitative requirements and ranking by importance of the above selection criteria, as well as the following guidelines for the technology available.

### Technology Overview

The performance of a linear guide is based upon contact type, rolling element type, inner race geometry (Round Rail and Profile Rail), and other characteristics such as self-aligning capabilities. It is important to recognize that the options available for each characteristic have performance attributes. The selection process should be focused on matching these attributes with the most critical requirements of the application. The following technology guidelines can be used to assist in selecting the most appropriate type of profile rail. For a detailed application analysis, contact the **Thomson Customer Support** or your local Thomson distributor.

## Sizing & Defining Guide Characteristics

The following 9 step procedure can be used to select the characteristics necessary to generate the appropriate part number:

1. Determine the load on the most heavily loaded carriage or bearing (see Applied Loading Calculations). Multiply by a safety factor if desired in your application.
2. Determine the minimum required travel life for the application based on the intended duty cycle.
3. Calculate the **Minimum Required Dynamic Load Rating**,  $C_{min}$ .
4. Select the size which offers the load rating,  $C$ , equal to or greater than the minimum required dynamic load rating,  $C_{min}$ . Also, consider **Dynamic Load Limit** and **Static Capacities**.
5. If the guide selected offers various preload<sup>†</sup> levels, select a preload based upon the allowable bearing deflection. Contact the factory for detailed deflection information. Some carriage or bearing **Deflection Charts** are provided in this catalog.

6. If the guide selected offers various accuracy classes, select an accuracy class based upon the required travel accuracy.
7. Determine the need for accessories or options.
8. Calculate the guide length based upon the stroke and platten length. Remember to include additional length of accessories (i.e. self-lubricating option) and the stroke reduction caused by the use of bellows, if applicable.
9. Once the above characteristics have been determined, assign the appropriate part number based on the part numbering instructions located in the catalog section corresponding to the linear guide selected.

<sup>†</sup> Choosing a higher preload level will reduce the allowable installation tolerances. For this reason, the minimum preload which meets the applications requirements should be selected. If the highest preload level does not meet the deflection requirements, a larger size may be required.

## Applied Loading Calculations

The majority of applications utilize a four carriage or bearing and two rail design for stability. Shown are four typical configurations and calculations for the resultant loads applied to each bearing. Resultant loads are divided into a horizontal and a vertical components, which represent the static or constant velocity condition and account for gravity but not acceleration.

Use the appropriate configuration to determine the horizontal and vertical components of the resultant applied load on the most heavily loaded carriage or bearing. These values will be referred to henceforth as FH & FV, respectively.

### Terms:

- $d_0$  = distance between centerlines of carriages or bearings (in) or (mm)
- $d_1$  = distance between centerlines of rails (in) or (mm)
- $d_2$  = distance from centerline of carriage or bearing to load action point (in) or (mm)
- $d_3$  = distance from centerline of carriage or bearing to load action point (in) or (mm)
- $W$  = Applied Load (lbf) or (N)
- FNH** = Horizontal component of resultant applied load with respect to each carriage or bearing (lbf) or (N)
- FNV** = Vertical component of resultant applied load with respect to each carriage or bearing (lbf) or (N)

### Reminder:

- Be sure to use consistent units (English or metric).
- Be sure to use the appropriate sign (positive or negative).
- A negative number is used when the actual force is in the opposite direction represented by the arrow.

$$F_{1v} = \frac{W}{4} + \left(\frac{W}{2} \cdot \frac{d_2}{d_0}\right) - \left(\frac{W}{2} \cdot \frac{d_3}{d_1}\right)$$

$$F_{2v} = \frac{W}{4} - \left(\frac{W}{2} \cdot \frac{d_2}{d_0}\right) - \left(\frac{W}{2} \cdot \frac{d_3}{d_1}\right)$$

$$F_{3v} = \frac{W}{4} - \left(\frac{W}{2} \cdot \frac{d_2}{d_0}\right) + \left(\frac{W}{2} \cdot \frac{d_3}{d_1}\right)$$

$$F_{4v} = \frac{W}{4} + \left(\frac{W}{2} \cdot \frac{d_2}{d_0}\right) + \left(\frac{W}{2} \cdot \frac{d_3}{d_1}\right)$$

**Horizontal Application I**  
At the time of movement with uniform velocity or at the time of stop.

$$F_{1v} = \frac{W}{4} + \left(\frac{W}{2} \cdot \frac{d_2}{d_0}\right) - \left(\frac{W}{2} \cdot \frac{d_3}{d_1}\right)$$

$$F_{2v} = \frac{W}{4} - \left(\frac{W}{2} \cdot \frac{d_2}{d_0}\right) - \left(\frac{W}{2} \cdot \frac{d_3}{d_1}\right)$$

$$F_{3v} = \frac{W}{4} - \left(\frac{W}{2} \cdot \frac{d_2}{d_0}\right) + \left(\frac{W}{2} \cdot \frac{d_3}{d_1}\right)$$

$$F_{4v} = \frac{W}{4} + \left(\frac{W}{2} \cdot \frac{d_2}{d_0}\right) + \left(\frac{W}{2} \cdot \frac{d_3}{d_1}\right)$$

**Horizontal Application II**  
At the time of movement with uniform velocity or at the time of stop.

$$F_{1v} = F_{2v} = - \left(\frac{W}{2} \cdot \frac{d_3}{d_1}\right)$$

$$F_{3v} = F_{4v} = + \left(\frac{W}{2} \cdot \frac{d_3}{d_1}\right)$$

$$F_{1H} = F_{4H} = \frac{W}{4} + \left(\frac{W}{2} \cdot \frac{d_2}{d_0}\right)$$

$$F_{2H} = F_{3H} = \frac{W}{4} - \left(\frac{W}{2} \cdot \frac{d_2}{d_0}\right)$$

**Side Mounted Application**  
At the time of movement with uniform velocity or at the time of stop.

$$F_{1v} = F_{4v} = - \left(\frac{W}{2} \cdot \frac{d_2}{d_0}\right)$$

$$F_{3v} = F_{2v} = + \left(\frac{W}{2} \cdot \frac{d_2}{d_0}\right)$$

$$F_{1H} = -F_{2H} = -F_{3H} = F_{4H} = \frac{W}{2} \cdot \frac{d_3}{d_1}$$

**Vertical Application**  
At the time of movement with uniform velocity or at the time of stop.  
At the time of start & stop, the load varies because of inertia.

## Equivalent Applied Load†

An equivalent load is used to consolidate applied load components into one value which can later be used to calculate the minimum required load rating and the expected life of the carriage/bearing selected.

### For ProfileRail\* Carriages & Closed RoundRail\* Bearings:

$$F_{EQ} = F_H + F_V$$

$F_{EQ}$  = Equivalent Load

$F_H$  = Horizontal Component of Resultant Applied Load

$F_V$  = Vertical Component of Resultant Applied Load

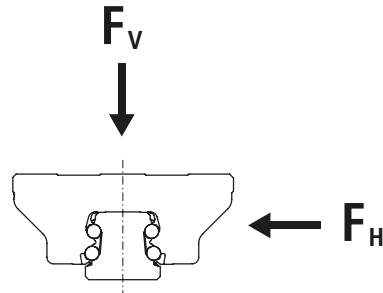

### For Single Carriage or Single Rail Configurations:

$$F_{EQ} = F_H + F_V + (M/M_C) \times C$$

$M$  = Applied Moment Load

$M_C$  = Dynamic Moment Capacity of Bearing

$C$  = Dynamic Load Capacity of Bearing

### For Preloaded Carriages [Only when $F_{EQ} < (3 \times F_p)$ ]:

Even with no external load applied, a preloaded bearing has a load on the races. A load greater than the externally applied load is present within a bearing with an externally applied load less than the preload end point. In order to calculate the loads on the load sets, the following formulae may be employed:

$$F_{EQ} = F_p + \frac{2}{3} (F_H + F_V)$$

$F_p$  = Initial Preload Force

(i.e., for 'B' Preload Designation  $F_p = .03 \times C$ )

† Before calculating  $F_{EQ}$ , make sure that neither  $F_H$  or  $F_V$  exceeds the Dynamic Load Limit of the guide intended for use. (See **Dynamic Load Limit** on Page 100).

‡ The 0.6 value used accounts for a derating factor of the capacity during tensile loading. Therefore, when calculating expected life based on  $F_{EQ}$ , the Full Dynamic Load Rating (C) may be used.



## Mean Dynamic Load

In applications with loads of varying magnitude, a mean dynamic load should be calculated.

$$F_{EQ} = P \sqrt{F_{EQ1}^P \left(\frac{d1}{D}\right) + F_{EQ2}^P \left(\frac{d2}{D}\right) + \dots + F_{EQn}^P \left(\frac{dn}{D}\right)}$$

Where:

$F_{EQ1} \dots F_{EQn}$  = equivalent dynamic load for distances  $d1$  through  $dn$

$D$  = total distance of stroke =  $d1+d2 \dots +dm$

$P = 3$  (linear guides w/Ball Type Rolling Elements)

$10/3$  (linear guides w/Roller Type Rolling Elements)

## Load Ratings for Rolling Element Guides

### Dynamic Load Rating, C, and Travel Life

The dynamic load rating, C, is the load at which when applied will yield the rated travel life. The rated travel life,  $L_r$ , for most linear guides is 100 km for metric products and 4 million inches for inch products (the rated travel life is listed on the page with the dynamic load rating). For a given applied load, P, the dynamic load rating and rated travel life are used to calculate the travel life using the following load/life equation:

$$L = (C/F_{EQ})^n \times L_r$$

Where:

$L$  = calculated travel life

$C$  = dynamic load rating

$F_{EQ}$  = equivalent applied load

$n$  = 3 for ball guides, 10/3 for roller guides

$L_r$  = rated travel life

Some manufacturers dynamic load ratings are based upon a 50 km life. To compare dynamic load ratings for guides with a 50 km rated life with a 100 km life, divide the 50 km dynamic load rating by 1.26.

$$C_{100 \text{ km}} = C_{50 \text{ km}} / 1.26$$

Some types of linear guides do not have the same dynamic load rating in all directions. The dynamic load rating for orthogonal load directions is shown as a percentage of C. It is not necessary to use this percentage of C in the load/life equation provided that the **Equivalent Applied Load Section** has been adhered to, because the calculations for equivalent applied load already account for it.

## Calculating the Minimum Required Dynamic Load Rating, $C_{min}$

The load/life equation above can be rewritten to calculate the minimum required dynamic load rating which should be selected for a given applied load and minimum required travel life:

$$C_{min} = P(L_m/L_r)^{1/n}$$

Where:

$C_{min}$  = minimum required dynamic load rating

$P$  = applied load

$L_m$  = minimum required travel life

$L_r$  = rated travel life

$n$  = 3 for ball guides, 10/3 for roller guides

Note: Check that the applied load,  $P$  does not exceed the dynamic load limit.

### Dynamic Load Limit

The dynamic load limit, is the maximum load which should be applied to the carriage/pillowblock. In some cases, the dynamic load capacity equals the dynamic load rating. In others, a limit shown as a percentage of the dynamic load rating is the maximum load which should be applied. A dynamic load limit less than the dynamic load rating does not derate the life of the guide.

### Static Capacities

The static capacities are the maximum loads that should be applied to the bearing while there is no relative motion between the rolling elements and the raceways. The value  $C_0$  is the static load capacity for a radial load acting orthogonal to the axis of travel. The values  $M_{0L}$  and  $M_{0Q}$  are the static roll, pitch, and yaw moment capacities.

It is important to analyze the application so that shock loads do not exceed these capacities. Exceeding these capacities may permanently deform the rolling elements and raceways. This type of damage will be realized by an increase in friction, noise, and vibration, as well as by an increase in clearance between the carriage and the rail.

For systems experiencing repetitive shock loading less than the static load capacities, the bearing life should be determined by means of fatigue calculations.

## Preloading & Linear Guide Deflection

### Preload

A preloaded bearing has a condition of interference between the races of the rails, the rolling elements, and the races of the carriage.

Preloading decreases the deflection due to external loads. This occurs because the contact reaction has already developed, eliminating much of the initial non-linear deflection associated with rolling elements.

The rolling element reactions within a preloaded bearing may be considered as having two components. One component acts in the direction of external load, and one component acts in the opposing direction in order to maintain static equilibrium. These components are referred to as load sets. As external load is applied, one load set increases in load, as the opposite load set decreases in load. At some point, the load on the decreasing load set becomes zero. This point, at which the preload is relieved, is called the preload end point. Preload end typically occurs when the external load is approximately three times the preload.

Preload end point:

$$F_{ext} = 3F_p$$

where:

$F_{ext}$  = externally applied load

$F_p$  = preload

By definition, a preloaded bearing, loaded beyond the preload endpoint, has the same deflection characteristics of an unpreloaded bearing externally loaded to that percentage of its dynamic load capacity. A preload level is assigned as a percentage of the dynamic load capacity of the bearing.

## Deflection Curves

The following pages contain deflection charts for the 500 Series Profile Rail Linear Guides. The charts shown are calculated. The calculation is based on theoretical conditions regarding shape, position and dimension of the balls and raceways of the carriage and rails under the specified loading. The real behavior of the carriage can vary slightly in the application as a result of base flatness, angle of loading, temperature, etc.

Note that the deflection decreases as the preload or the bearing size increases.

## Example Applications

Preload	Clearance	.03C	.08 - .13C
<b>Conditions</b>	1. weak impact 2. 2 rails in pair 3. low accuracy 4. small resistance	1. cantilever 2. single rail 3. light load 4. high accuracy	1. strong impact 2. strong vibration 3. heavy machining
<b>Applications</b>	1. welding machine 2. chopping machine 3. feeding mechanism 4. tool change mechanism 5. ordinary XY table	1. NC lathe 2. EDM 3. precise XY table 4. ordinary Z-axis 5. industrial robot 6. PCB punching	1. machining centre 2. NC lathe and milling machine 3. feeding axis of grinder 4. tool feeding axis

## Deflection vs. Applied Load

511 Style A, C, E  
Size 15

### Compressive Load

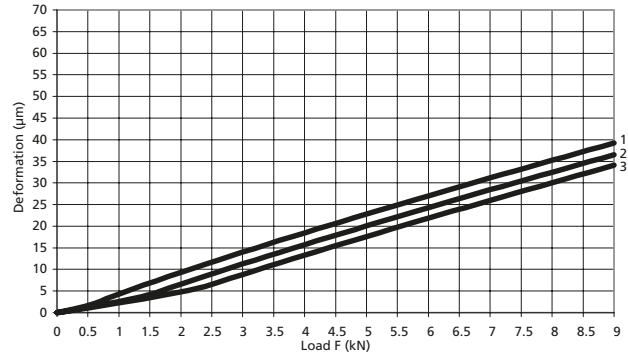
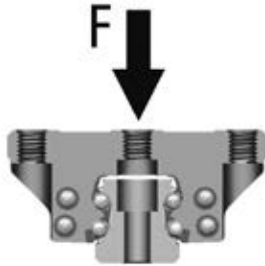

### Tensile Load

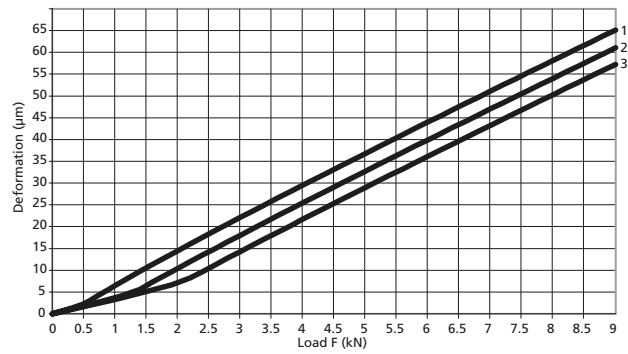
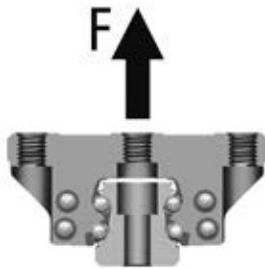

### Lateral Load

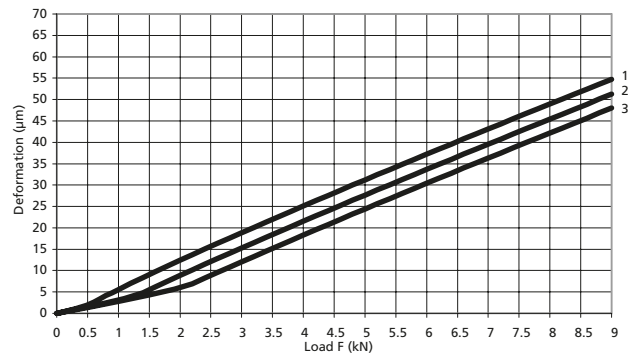
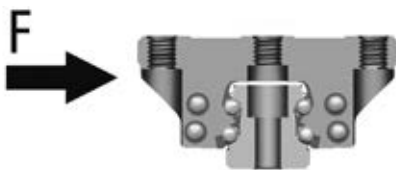

1. Preload 3% of C
  2. Preload 8% of C
  3. Preload 13% of C
- C = Dynamic load carrying capacity

## Deflection vs. Applied Load

511 Style A, C, E  
Size 20

### Compressive Load

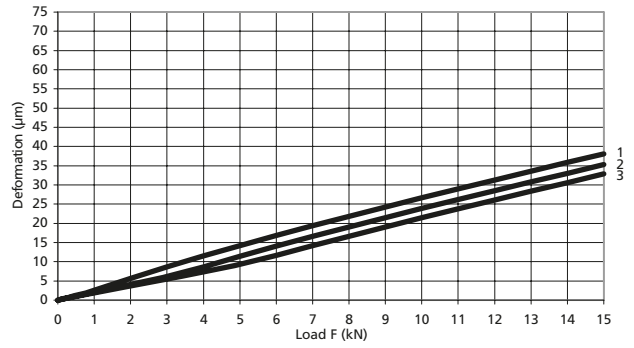
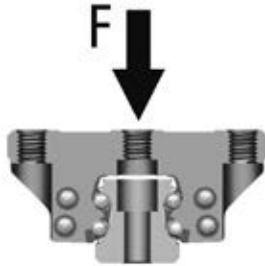

### Tensile Load

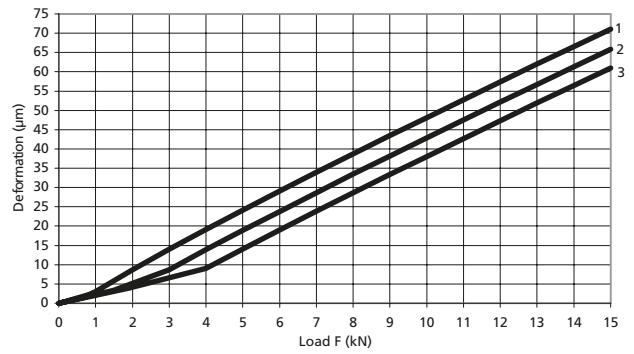
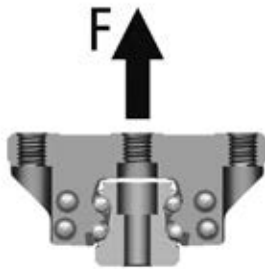

### Lateral Load

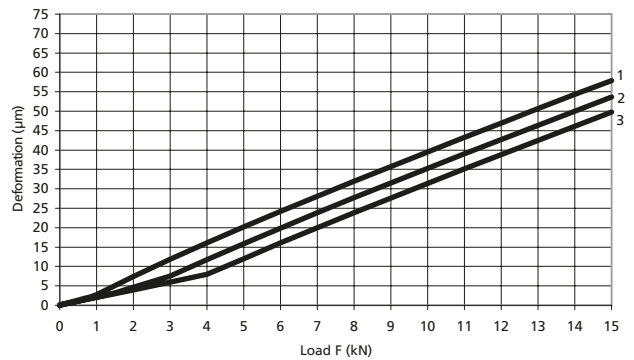
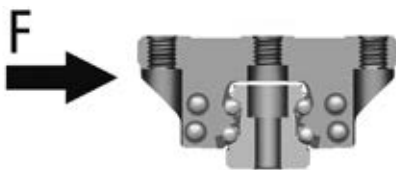

- 1. Preload 3% of C
  - 2. Preload 8% of C
  - 3. Preload 13% of C
- C = Dynamic load carrying capacity

## Deflection vs. Applied Load

511 Style B, D, F  
Size 20

### Compressive Load

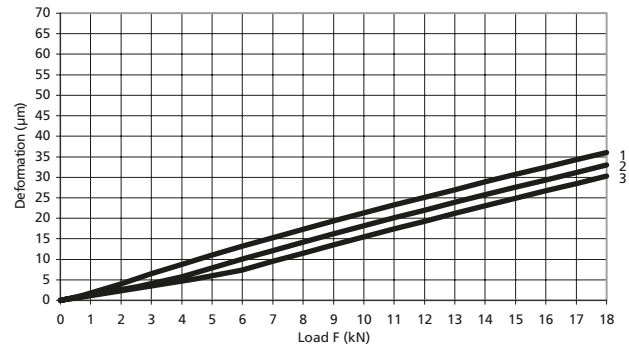
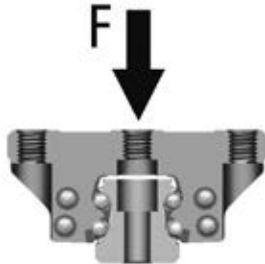

### Tensile Load

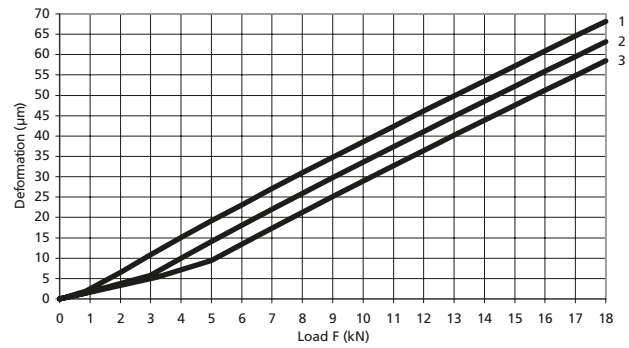
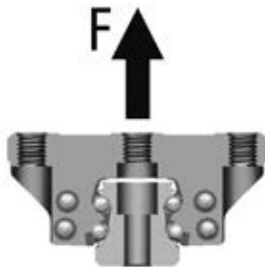

### Lateral Load

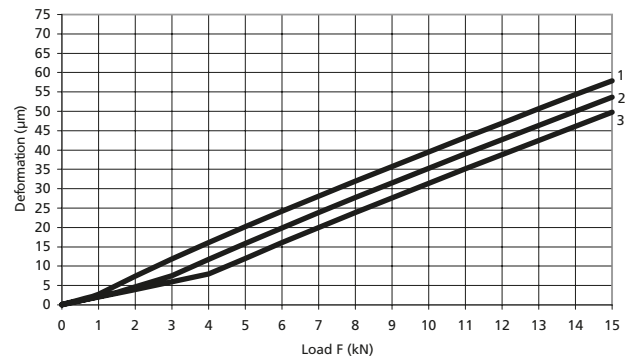
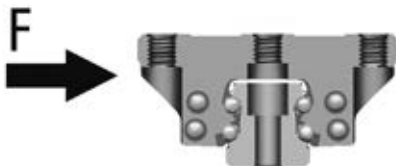

- 1. Preload 3% of C
  - 2. Preload 8% of C
  - 3. Preload 13% of C
- C = Dynamic load carrying capacity

## Deflection vs. Applied Load

511 Style A,C,E  
Size 25

### Compressive Load

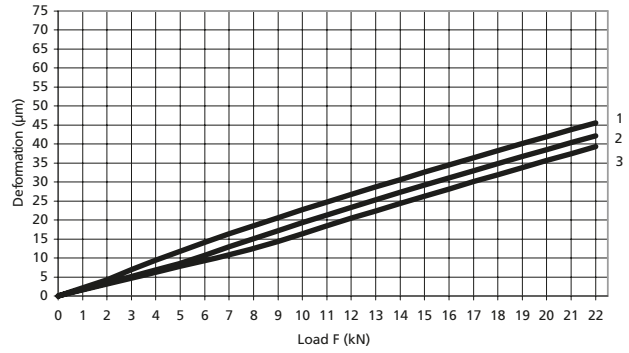
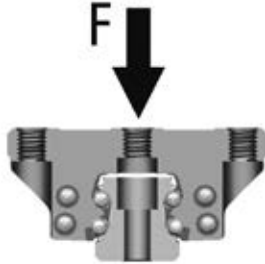

### Tensile Load

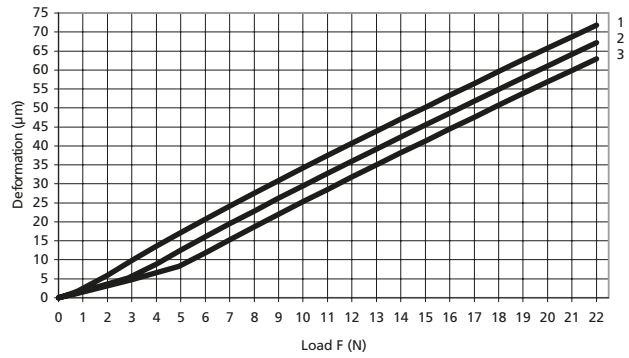
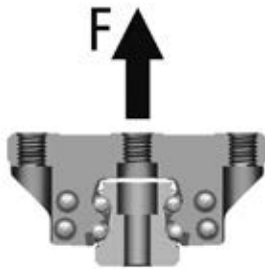

### Lateral Load

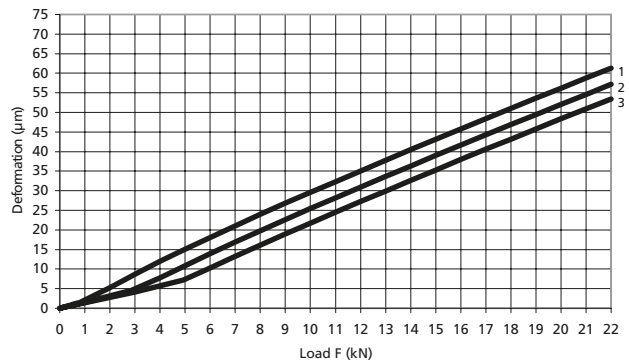
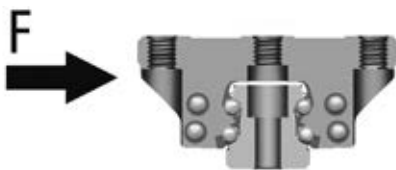

- 1. Preload 3% of C
  - 2. Preload 8% of C
  - 3. Preload 13% of C
- C = Dynamic load carrying capacity

## Deflection vs. Applied Load

511 Style B, D, F  
Size 25

### Compressive Load

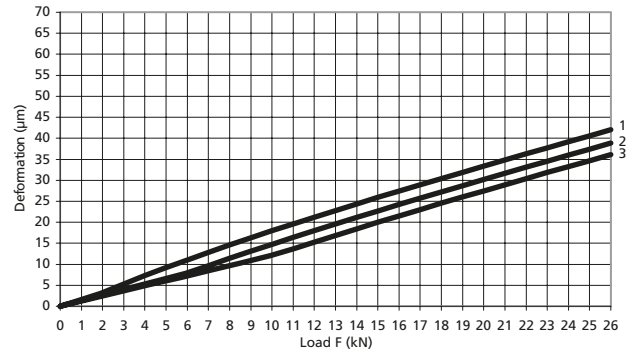
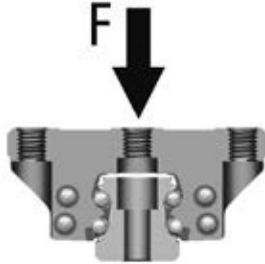

### Tensile Load

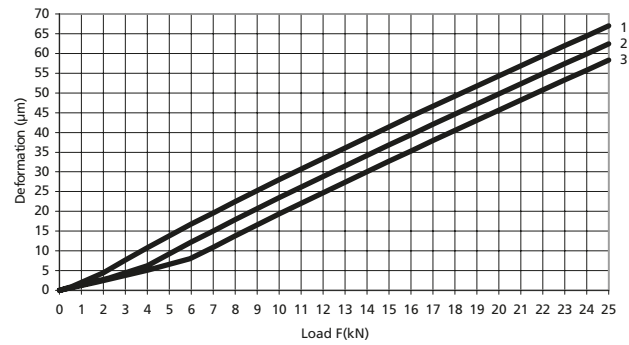
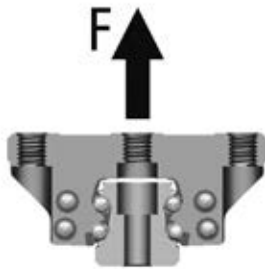

### Lateral Load

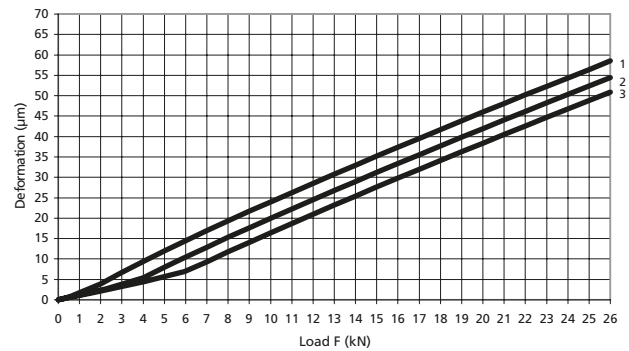
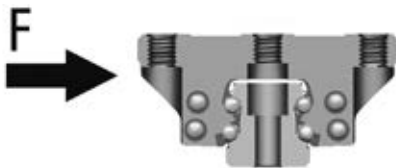

- 1. Preload 3% of C
  - 2. Preload 8% of C
  - 3. Preload 13% of C
- C = Dynamic load carrying capacity



## Deflection vs. Applied Load

511 Style A,C,E  
Size 30

### Compressive Load

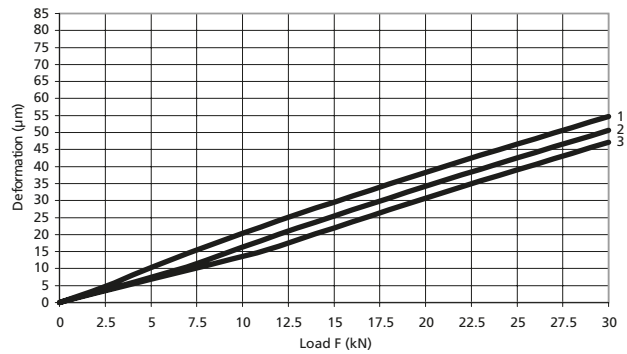
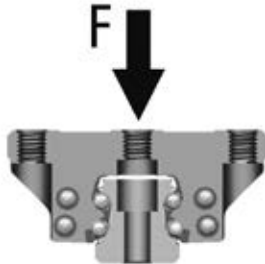

### Tensile Load

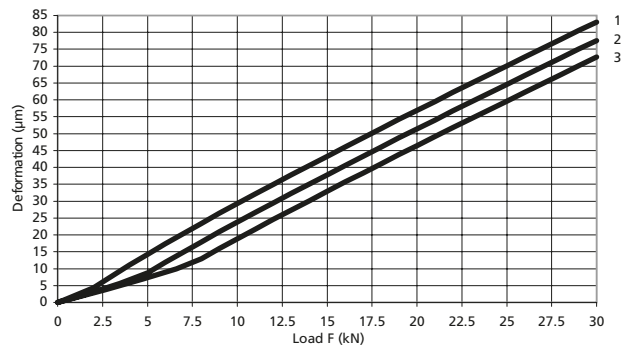
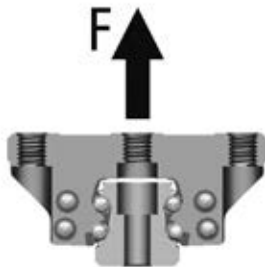

### Lateral Load

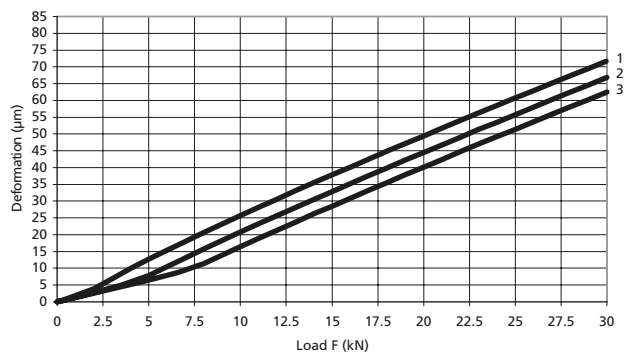
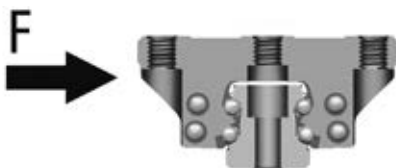

- 1. Preload 3% of C
  - 2. Preload 8% of C
  - 3. Preload 13% of C
- C = Dynamic load carrying capacity

## Deflection vs. Applied Load

511 Style B, D, F  
Size 30

### Compressive Load

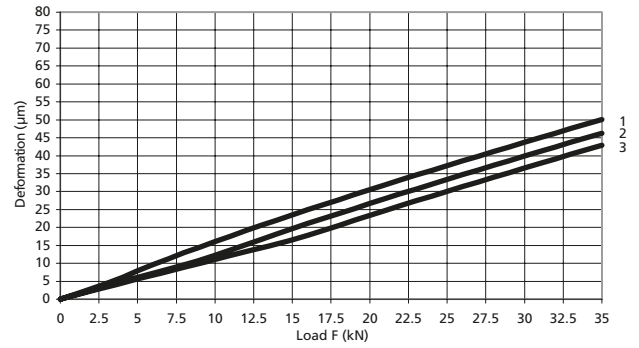
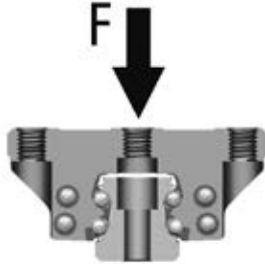

### Tensile Load

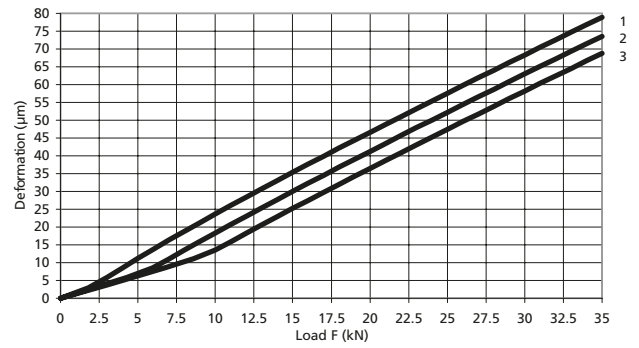
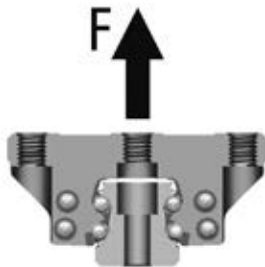

### Lateral Load

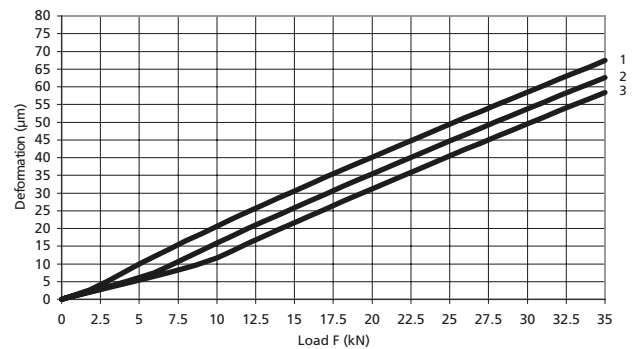
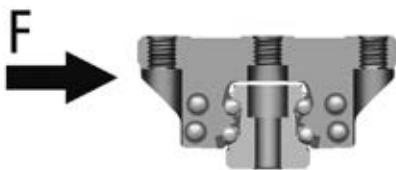

- 1. Preload 3% of C
  - 2. Preload 8% of C
  - 3. Preload 13% of C
- C = Dynamic load carrying capacity

## Deflection vs. Applied Load

511 Style A,C,E  
Size 35

### Compressive Load

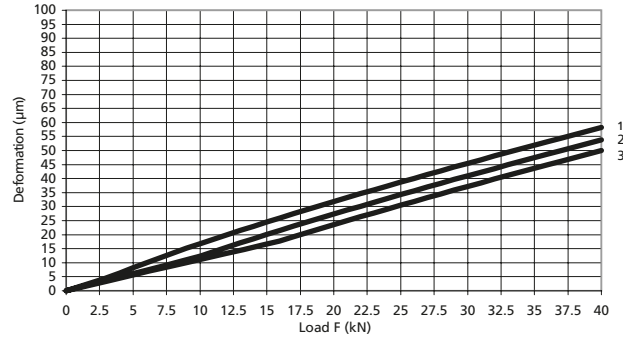
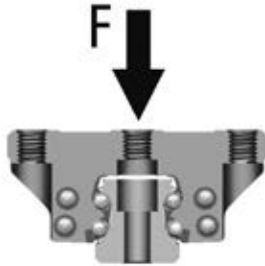

### Tensile Load

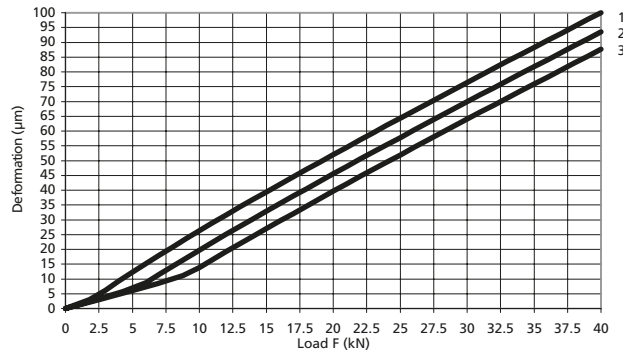
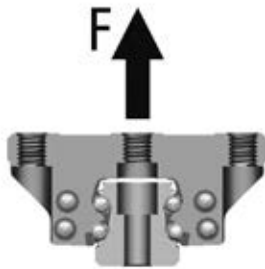

### Lateral Load

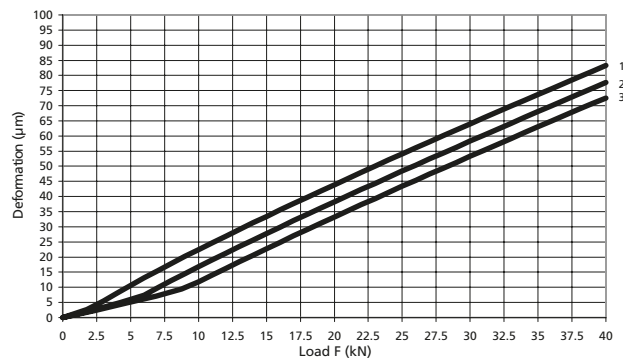
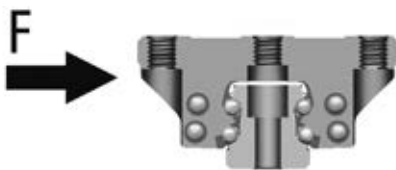

- 1. Preload 3% of C
  - 2. Preload 8% of C
  - 3. Preload 13% of C
- C = Dynamic load carrying capacity

## Deflection vs. Applied Load

511 Style B, D, F  
Size 35

### Compressive Load

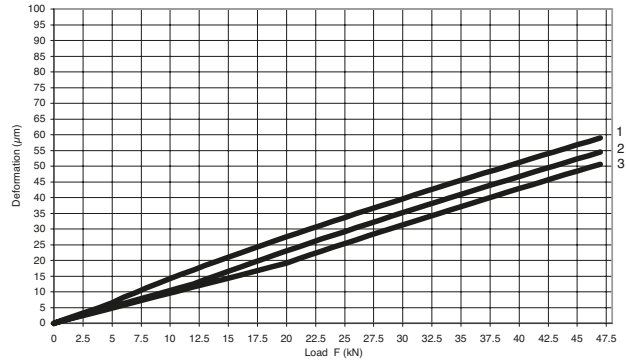
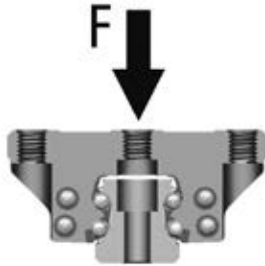

### Tensile Load

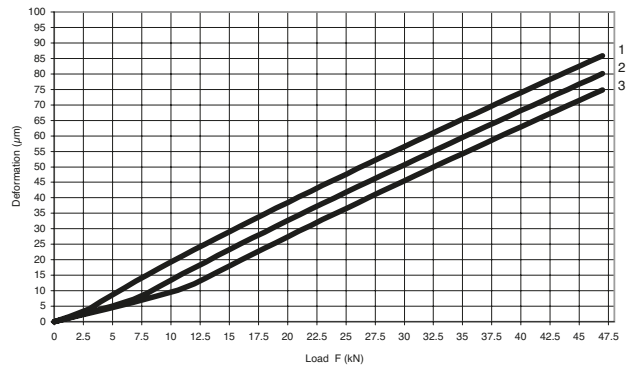
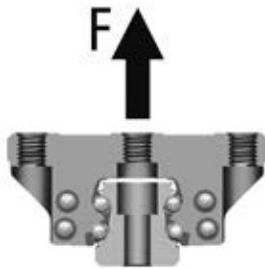

### Lateral Load

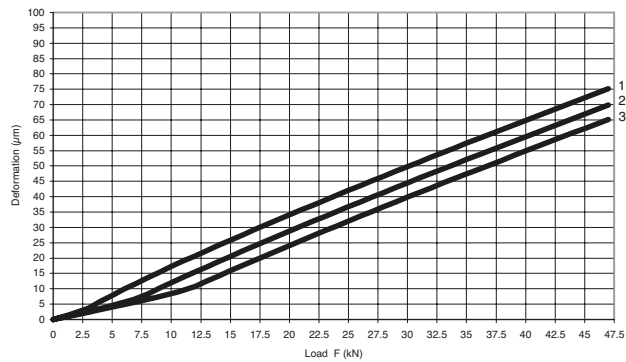
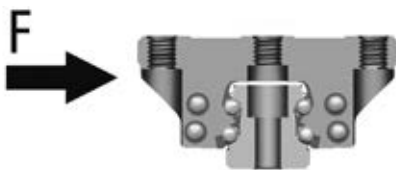

1. Preload 3% of C
  2. Preload 8% of C
  3. Preload 13% of C
- C = Dynamic load carrying capacity

## Deflection vs. Applied Load

511 Style A,C,E  
Size 45

### Compressive Load

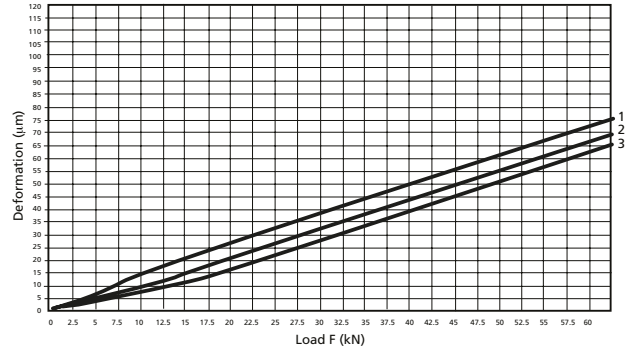
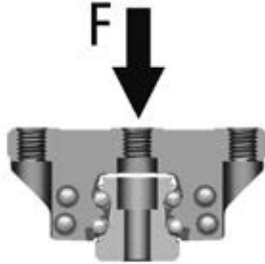

### Tensile Load

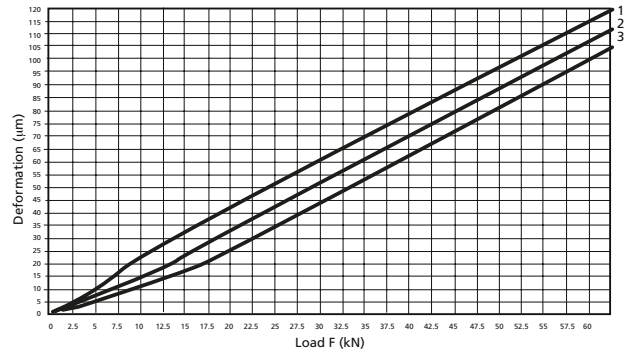
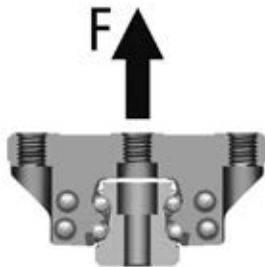

### Lateral Load

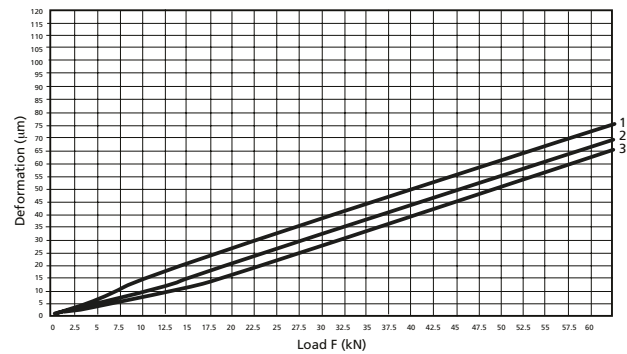
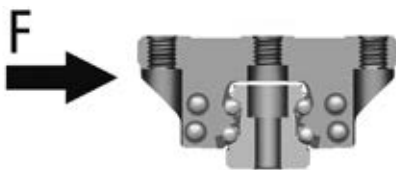

1. Preload 3% of C
  2. Preload 8% of C
  3. Preload 13% of C
- C = Dynamic load carrying capacity

## Deflection vs. Applied Load

511 Style B, D, F  
Size 45

### Compressive Load

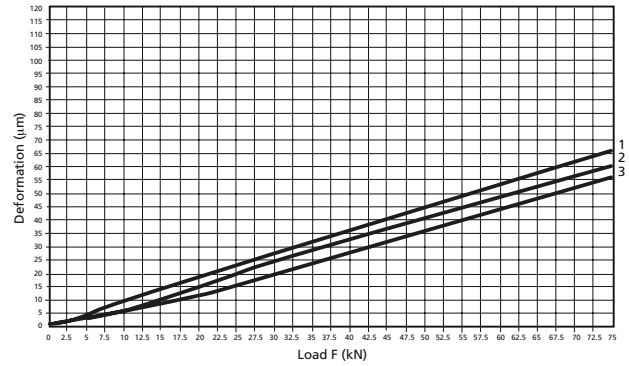
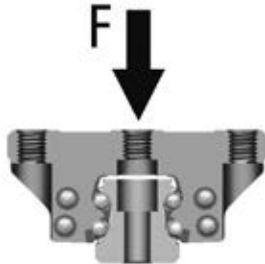

### Tensile Load

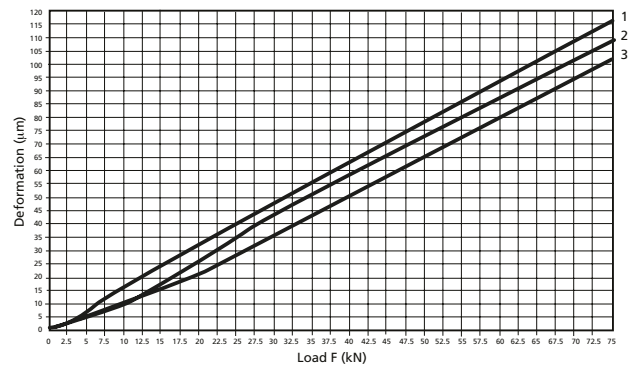
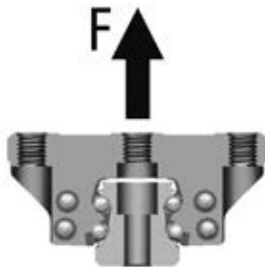

### Lateral Load

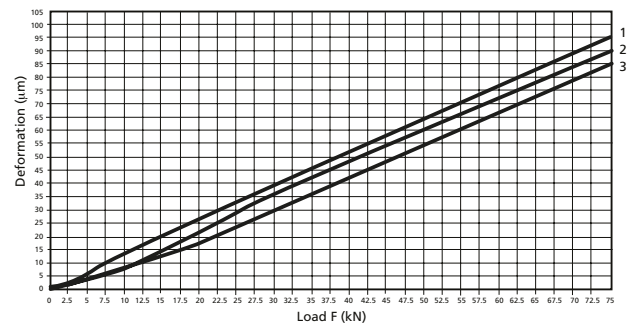
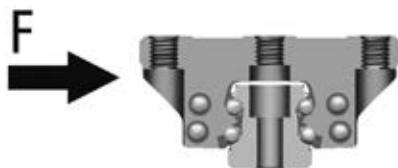

- 1. Preload 3% of C
  - 2. Preload 8% of C
  - 3. Preload 13% of C
- C = Dynamic load carrying capacity

## Deflection vs. Applied Load

512 Style A and C  
Size 25

### Compressive Load

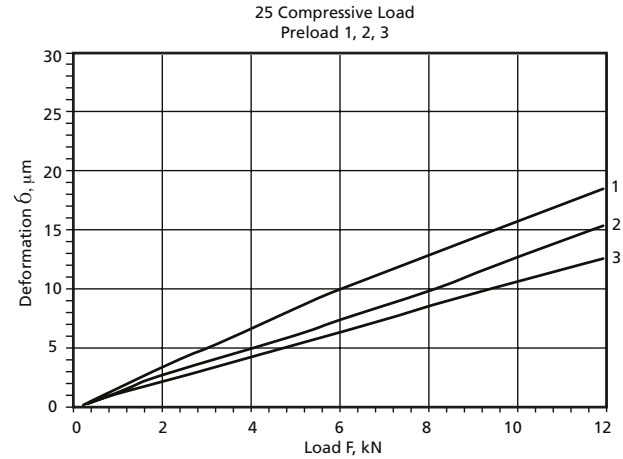
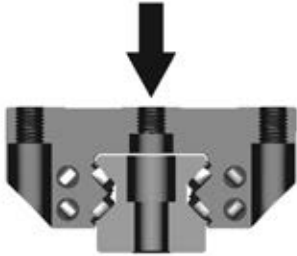

### Tensile Load

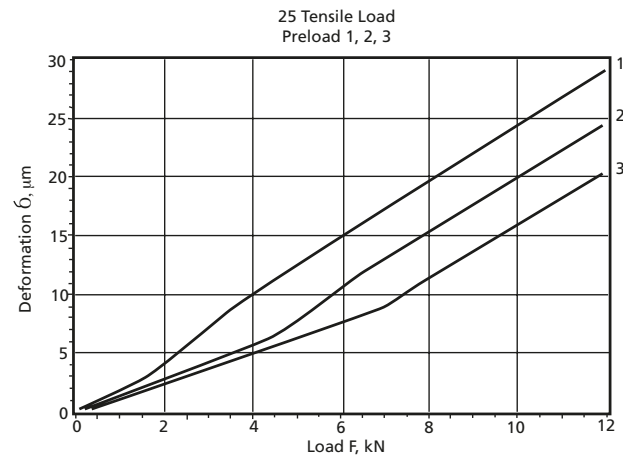
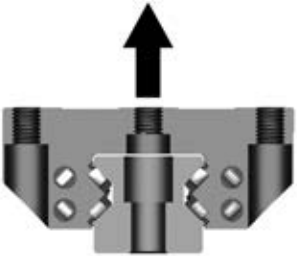

### Lateral Load

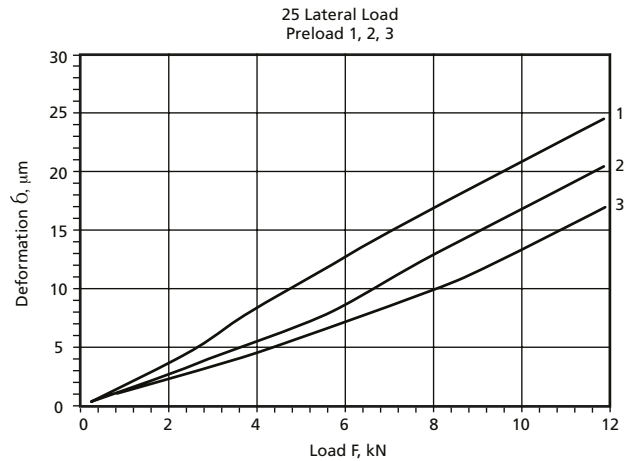

- 1. Preload 3% of C
  - 2. Preload 8% of C
  - 3. Preload 13% of C
- C = Dynamic load carrying capacity

## Deflection vs. Applied Load

512 Style B and D  
Size 25

### Compressive Load

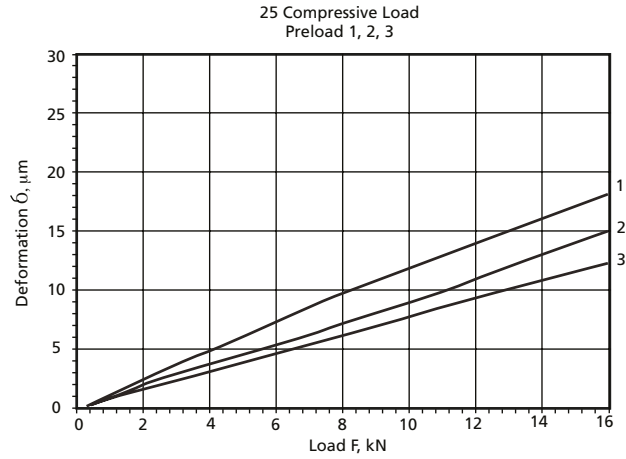
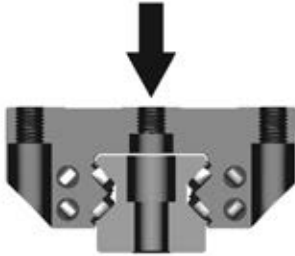

### Tensile Load

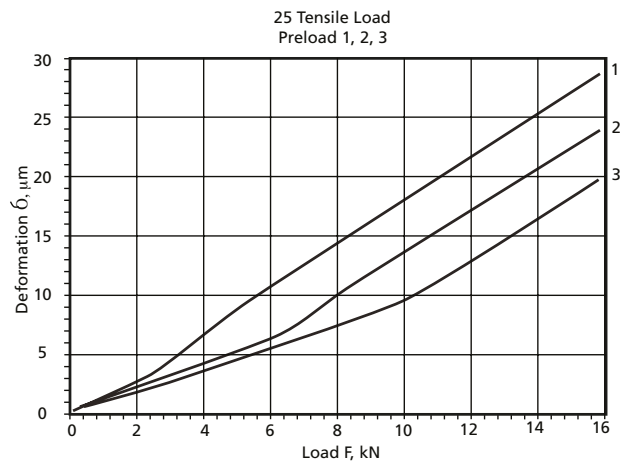
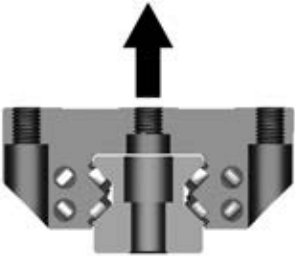

### Lateral Load

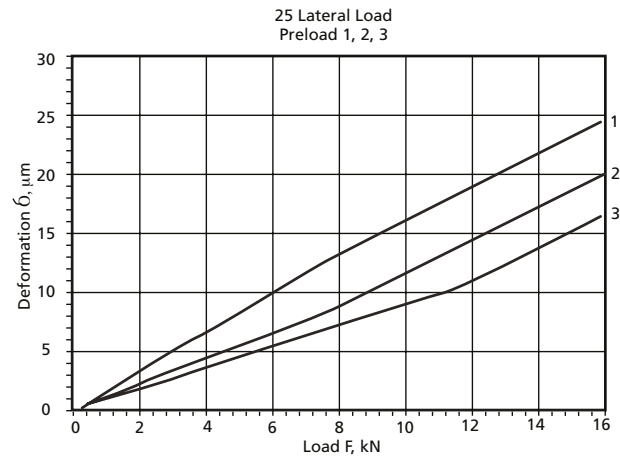
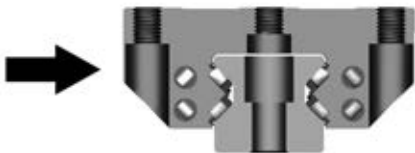

- 1. Preload 3% of C
  - 2. Preload 8% of C
  - 3. Preload 13% of C
- C = Dynamic load carrying capacity



## Deflection vs. Applied Load

512 Style A and C  
Size 35

### Compressive Load

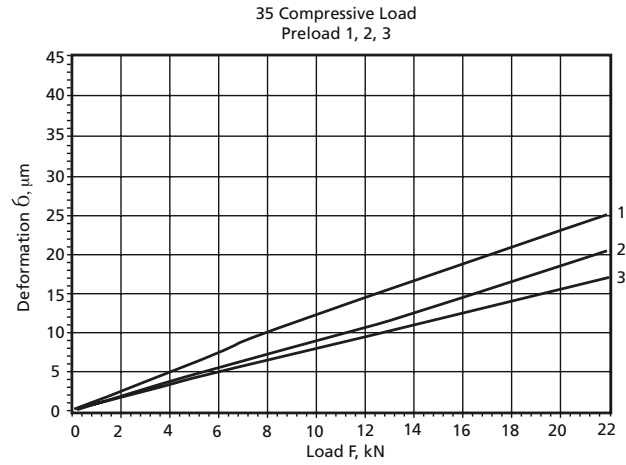
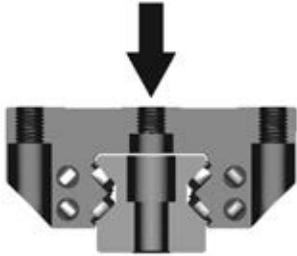

### Tensile Load

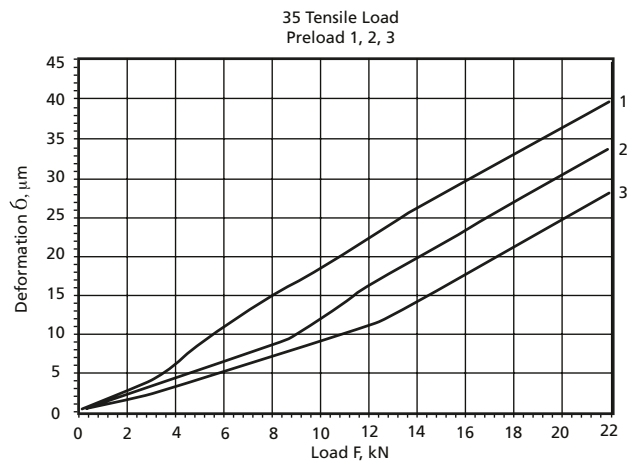
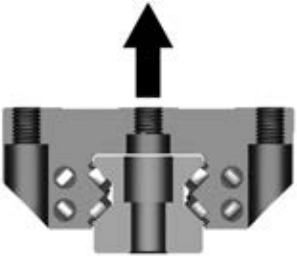

### Lateral Load

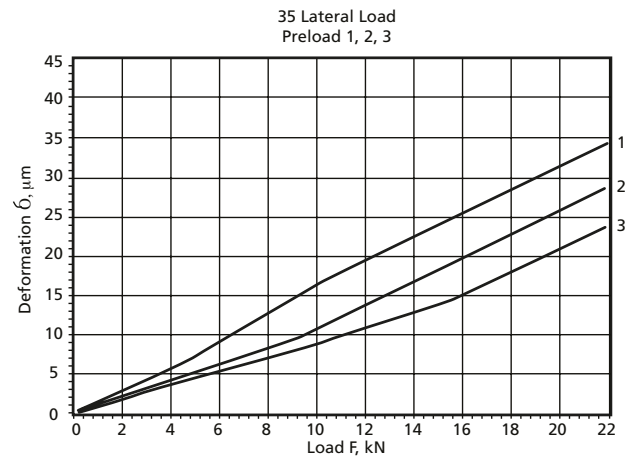
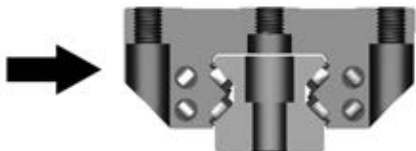

- 1. Preload 3% of C
  - 2. Preload 8% of C
  - 3. Preload 13% of C
- C = Dynamic load carrying capacity

## Deflection vs. Applied Load

512 Style B and D  
Size 35

Compressive Load

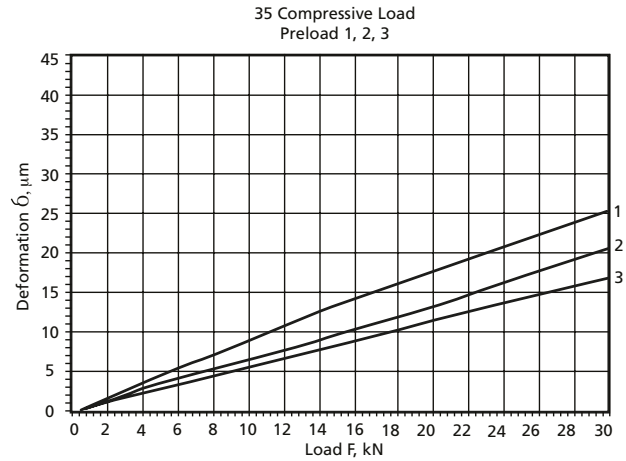
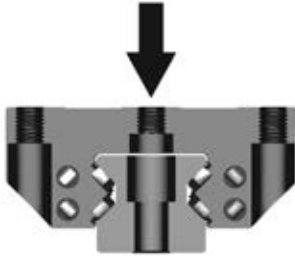

Tensile Load

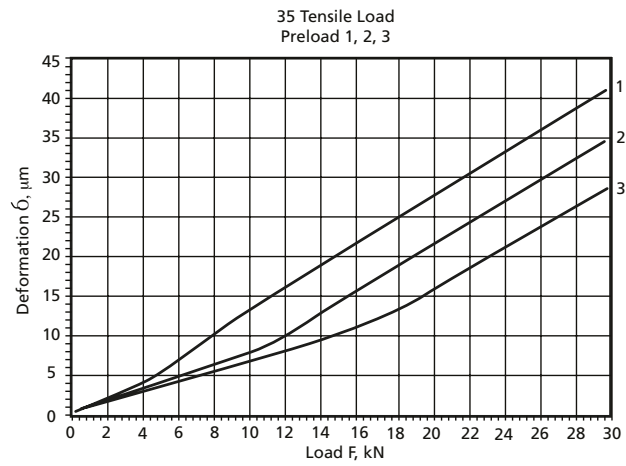
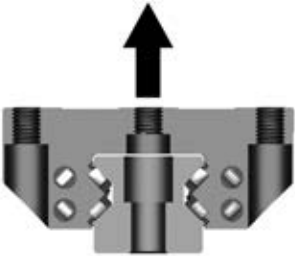

Lateral Load

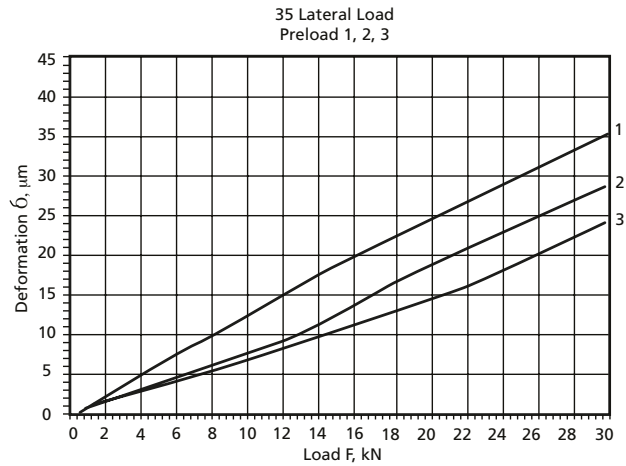
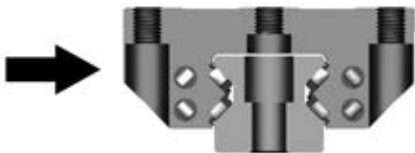

- 1. Preload 3% of C
  - 2. Preload 8% of C
  - 3. Preload 13% of C
- C = Dynamic load carrying capacity

## Deflection vs. Applied Load

512 Style A and C  
Size 45

### Compressive Load

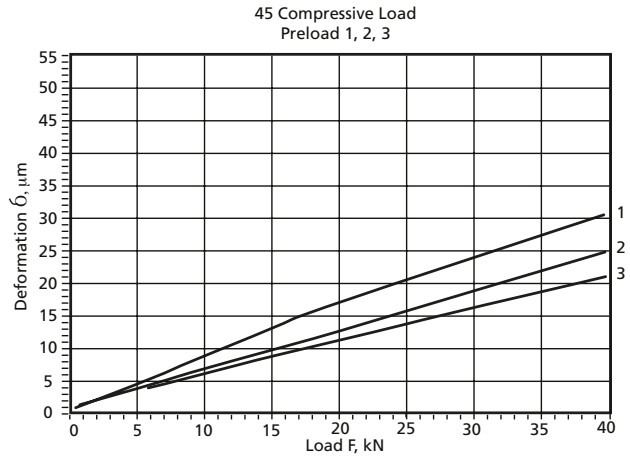
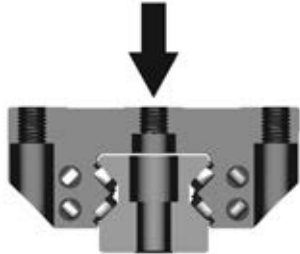

### Tensile Load

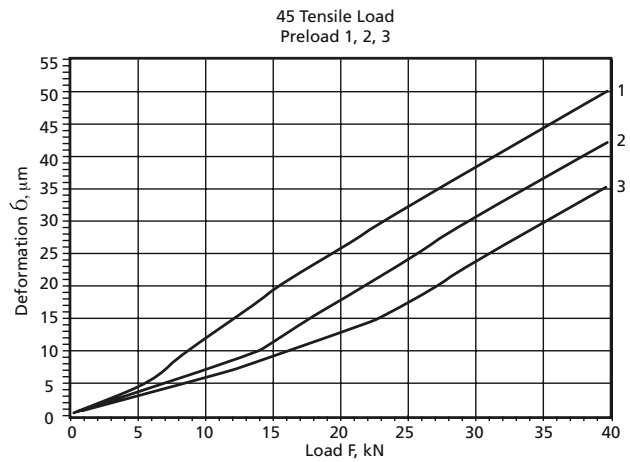
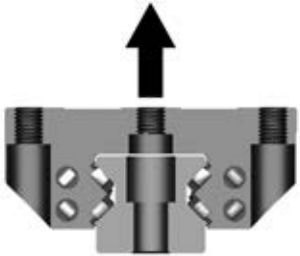

### Lateral Load

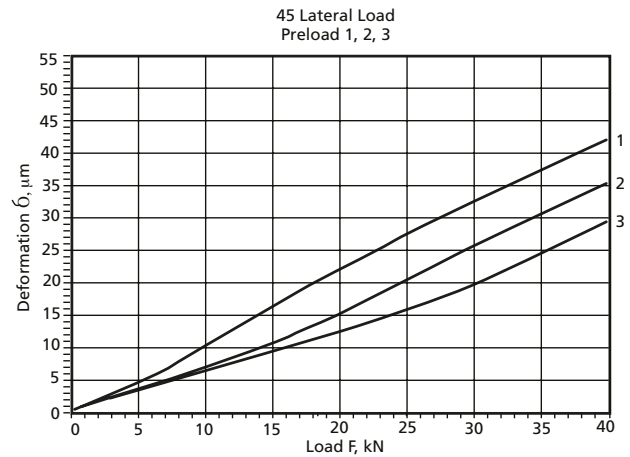
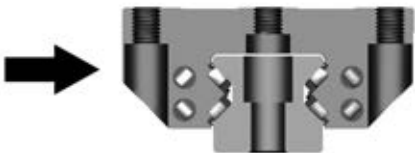

- 1. Preload 3% of C
- 2. Preload 8% of C
- 3. Preload 13% of C
- C = Dynamic load carrying capacity

## Deflection vs. Applied Load

512 Style B and D  
Size 45

Compressive Load

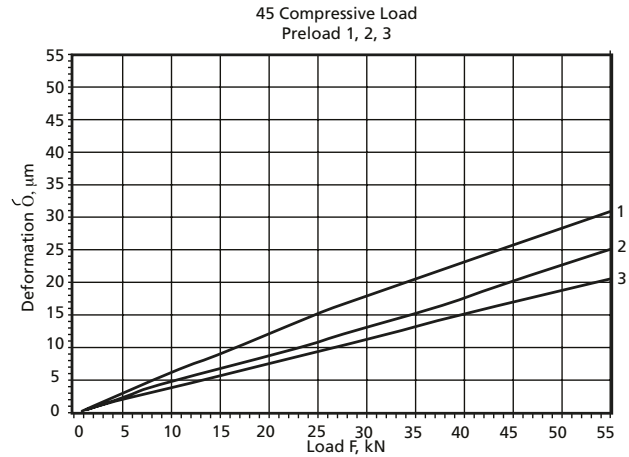
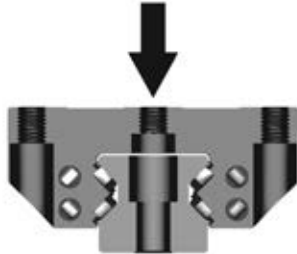

Tensile Load

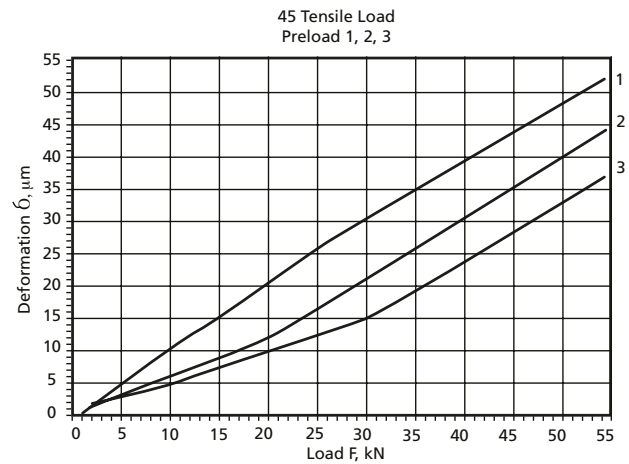
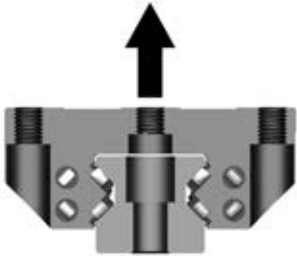

Lateral Load

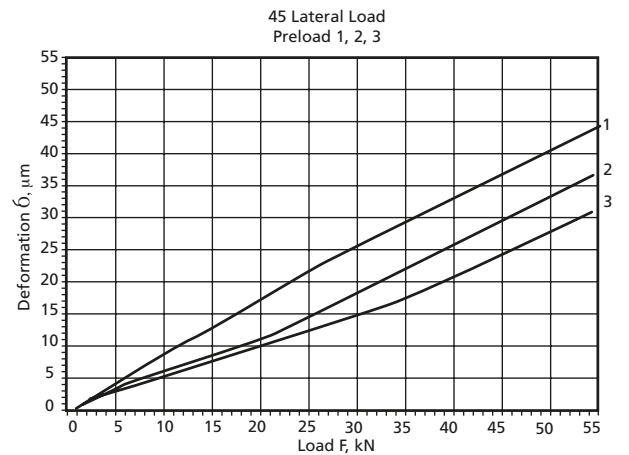
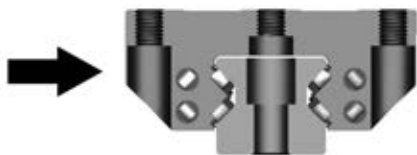

- 1. Preload 3% of C
  - 2. Preload 8% of C
  - 3. Preload 13% of C
- C = Dynamic load carrying capacity

## Deflection vs. Applied Load

512 Style A and C  
Size 55

### Compressive Load

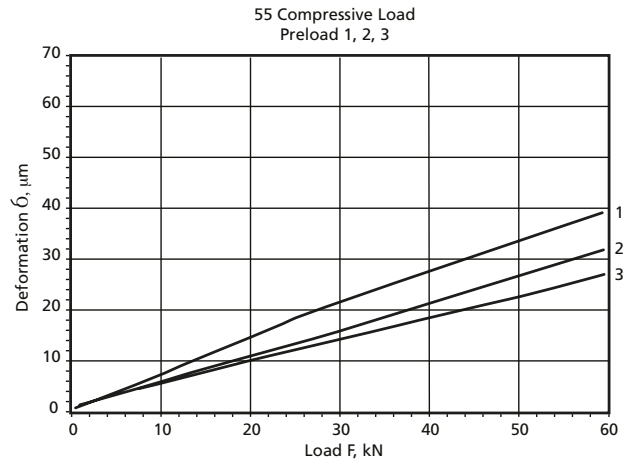
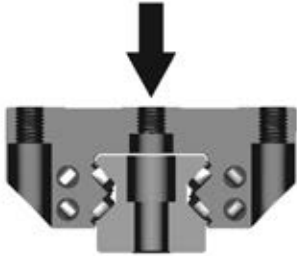

### Tensile Load

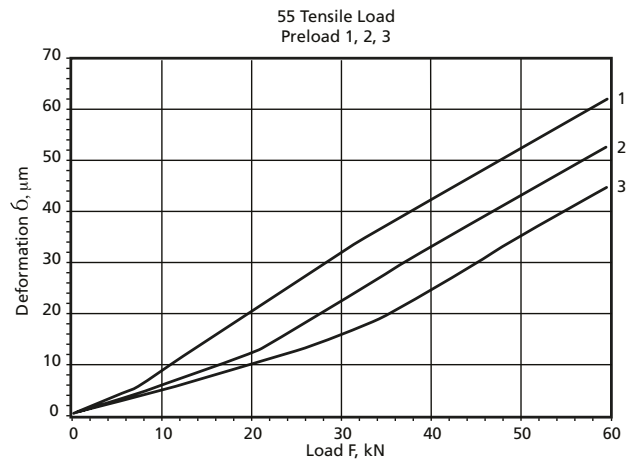
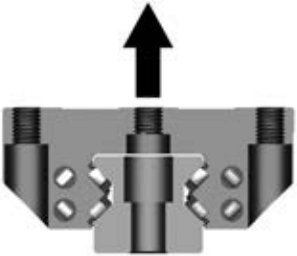

### Lateral Load

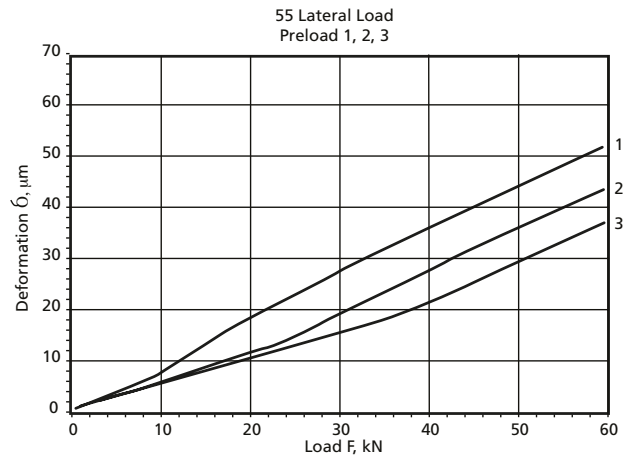
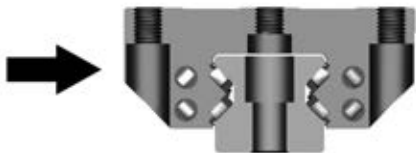

- 1. Preload 3% of C
  - 2. Preload 8% of C
  - 3. Preload 13% of C
- C = Dynamic load carrying capacity

## Deflection vs. Applied Load

512 Style B and D  
Size 55

Compressive Load

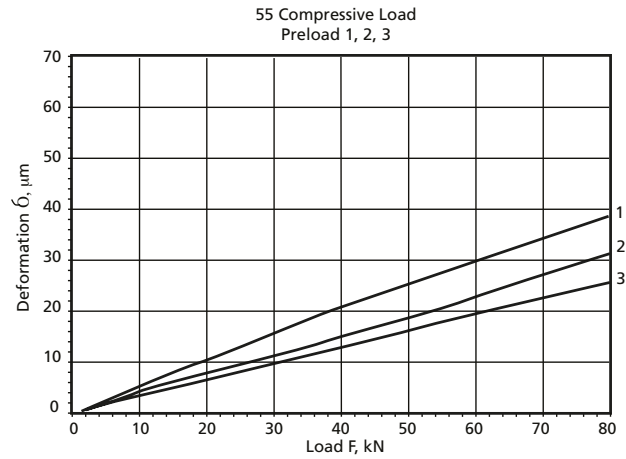
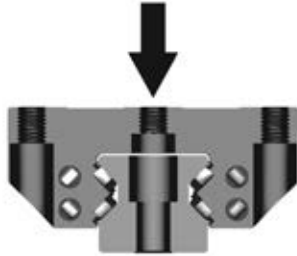

Tensile Load

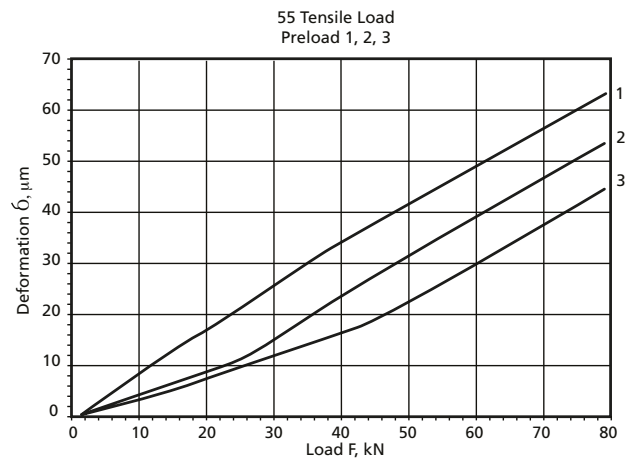
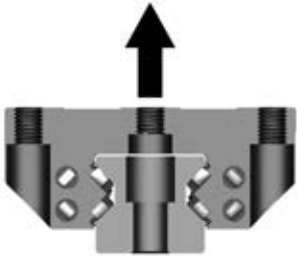

Lateral Load

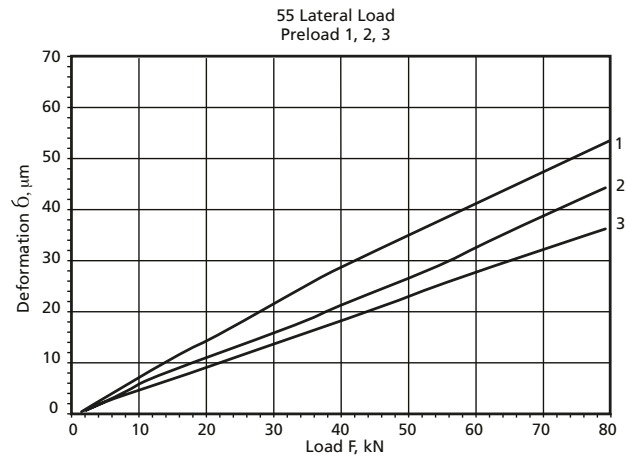
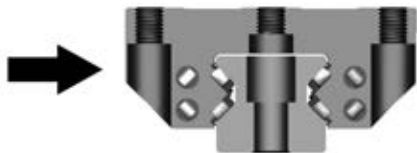

- 1. Preload 3% of C
  - 2. Preload 8% of C
  - 3. Preload 13% of C
- C = Dynamic load carrying capacity

## Deflection vs. Applied Load

512 Style A and C  
Size 65

### Compressive Load

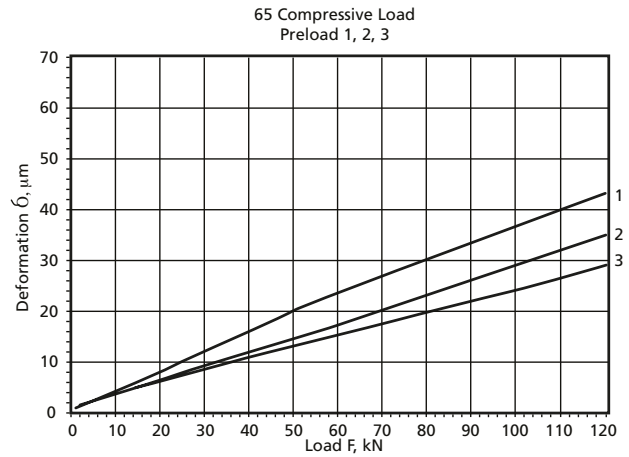
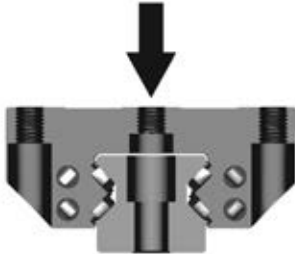

### Tensile Load

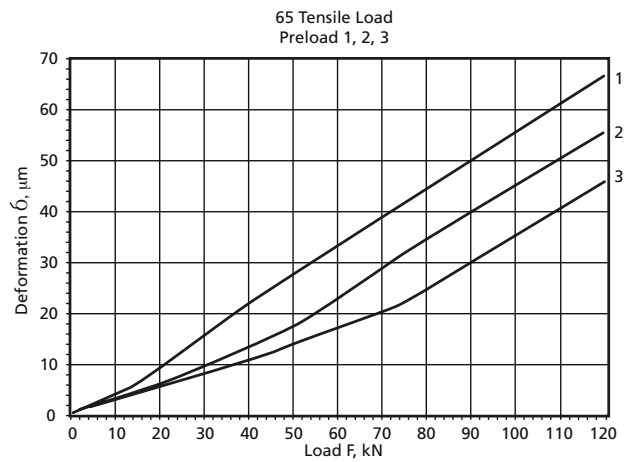
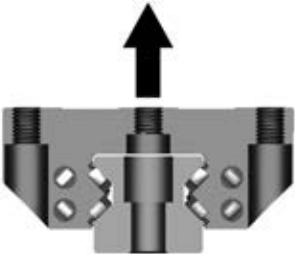

### Lateral Load

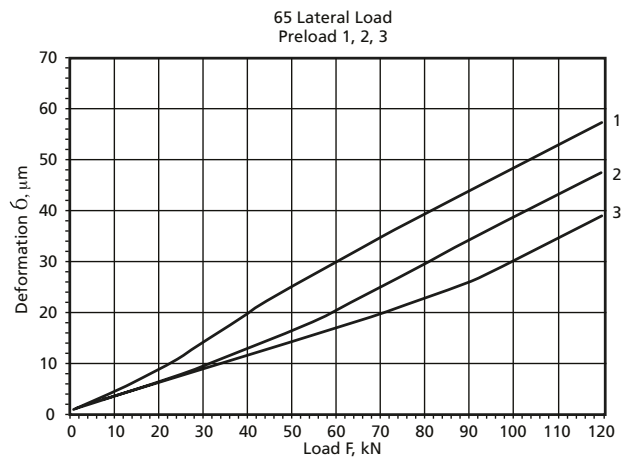
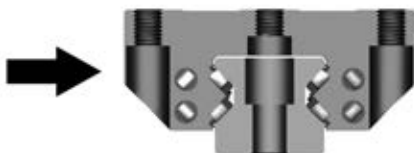

- 1. Preload 3% of C
  - 2. Preload 8% of C
  - 3. Preload 13% of C
- C = Dynamic load carrying capacity

## Actuation Force

The force required to actuate a linear guide (FA) has four basic components:

1. Frictional resistance ( $F_f$ )
2. Intrinsic resistance ( $D_{int}$ )
3. Inertia of the moving components ( $F_{inertia}$ )
4. Viscose drag of the lubrication ( $D_l$ )

$$F_A = F_f + D_{int} + F_{inertia} + D_l$$

## Frictional Resistance

### Rolling Element Guides

Friction occurs in rolling element guides as a result of slipping of the rolling elements on the raceways. The frictional resistance can be calculated by means of the following equation:

$$F_f = \mu \times F_i$$

Where:

$\mu$  = coefficient of friction (dependent upon type of guide type, rolling element type and load)

$F_i$  = force internal to the linear guide

The following table lists the coefficient of friction for different types of guides:

Profile Rail	
Ball Type	Roller Type
0.002 - 0.003	0.001 - 0.002

The value for the coefficient of friction is a function of the applied load. The coefficient of friction increases as load is applied. This is due to the increased contact area between the rolling elements and races.

The force internal to the linear guide is equal to the external force ( $F_{ext}$ ) applied to the linear guide in non-preloaded guides, and preloaded guides loaded beyond 3 times the preload value ( $F_p$ ).

$$F_i = F_{ext}$$

For preloaded guides loaded below a level of 3 times the preload value ( $F_p$ ), the internal force can be approximated with the following equation:

$$F_i = 2F_p + 1/3 F_{ext}$$



## Intrinsic Resistance

The intrinsic resistance is the measured actuation force required to move the guide at a constant velocity, without lubrication, regardless of load. It consists of the seal drag (larger component) and force required to circulate the rolling elements (smaller component). The intrinsic resistance can be assumed to be a constant for linear guides carrying more than 5% of their dynamic load rating (C). For guides loaded below that value, the force required to circulate the rolling elements will increase.

The following chart shows the intrinsic resistance,  $D_{intr}$  for different types and sizes of linear guides.

### Inertia of Moving Components

Inertia is directly related to the mass and acceleration by the following equation:

$$F_{inertia} = Ma$$

### Viscose Drag of the Lubrication

The viscose drag of the lubricant is dependent upon the viscosity of the lubricant selected.

### Preload

Preload of the assembly has an effect on intrinsic resistance, the greater the preload the greater the intrinsic resistance to move the guide.

### 500 Series Ball Profile Rail

Size $D_{int}$ (N)	Carriage Style A, C $D_{int}$ (N)		Carriage Style B, D $D_{int}$ (N)	
	0.03C	0.13C	0.03C	0.13C
15	7	15	8	14
20	10	16	11	18
25	13	22	14	22
30	16	26	19	30
35	23	37	25	41
45	27	44	30	49

Values for lubricant oil VG 68, speed 0.1 m/s

### 500 Series Roller Profile Rail

Size	Carriage Style A, C $D_{int}$ (N)	Carriage Style B, D $D_{int}$ (N)
	25	17
35	35	51
45	53	60
55	98	124
65	—	170

Value for 0.13 C Preload, lubricant oil VG68, speed 0.1 m/s

## Lubrication

Lubrication provides protection against wear, corrosion, heat, and friction. Application-specific variables, such as load, speed, and environmental conditions, determine the most suitable lubricant and lubrication schedule for that specific application.

Thomson's general lubricant recommendation for linear guides is a grade 2 grease. A maximum of one year or 100 km, whichever comes first, between applications of lubricant is recommended. A grease with an extreme pressure additive should be used for guides loaded beyond 50 of their dynamic load rating (C). Oil can also be used and is recommended in applications where the bearings experience high speeds. Use the uppermost lubrication port on oil-lubricated bearings that are vertically oriented to ensure gravity-assisted lubricant dispersal.

Linear guide products are supplied with a light coating of preservative oil. This preservative oil is for storage purposes only and is not recommended as lubrication for the bearing.

### Lubrication Procedure

For best lubrication dispersal, the carriage should be moved on the rail while applying lubricant to ensure circulation to all internal bearing surfaces. It is not possible to over lubricate the bearings, as excess lubricant will merely exit the carriage under the seals.

Recommended initial volumes of lubricant for 500 Series bearings are shown in the tables. The recommended volume for relubrication is 1/2 the initial volume.

### Short Stroke

In the case of a stroke less than 2X's the carriage length, two lubrication connections are recommended, one at each end to ensure adequate lubrication to the entire ball or roller track.

### Oil Reservoir

The oil reservoir is supplied from the factory ready for installation (filled with oil). Relubrication is dependent upon many factors such as speeds, temperature, cleanliness, etc. The following is a guideline for relubrication. (It is recommended to relubricate every 12 months.)

The oil reservoir is filled in the factory with Kluber Lamora D220 oil. If relubricating with different oil it is the responsibility of the user to determine oil compatibility. The recommended refill quantity is shown in the table.

### Initial Grease Volume for 500 Series Ball Bearings

Size	Carriage Style A, C, E (cm <sup>3</sup> )	Carriage Style B, D, F (cm <sup>3</sup> )
15	0.9	—
20	1.7	2.1
25	2.8	3.5
30	4.7	5.8
35	6.6	8.1
45	12.6	15.6

### Initial Grease Volume for 500 Series Roller Bearings

Size	Carriage Style A, C (cm <sup>3</sup> )	Carriage Style B, D (cm <sup>3</sup> )
25	1.9	2.2
35	2.9	3.7
45	5.3	6.6
55	10.6	10.6
65	—	18.9

### Oil Reservoir Refill Quantity

Size	500 Series Ball 5310W Oil (cm <sup>3</sup> )	500 Series Roller 5320W Oil Qty (cm <sup>3</sup> )
15	0.5	—
20	1.4	—
25	2.4	2.2
30	2.9	—
35	5.	6
45	10.9	11
55	—	19
65	—	43

### Relubrication

Size	15	20	25	30	35	45	55	65
Travel Distance	2500 km						5000 km	

## Self-Lubricating Profile Rail Lube Block

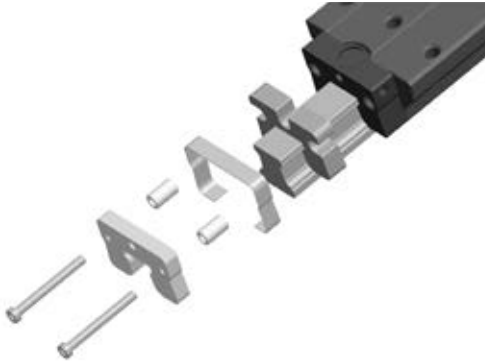

The self-lubricating Lube Block option offers maintenance free operation and enhanced protection for a broad range of applications. It offers:

- Reduced system cost by eliminating the need for designing, purchasing, and installing expensive lubrication systems.
- Environmentally friendly operation.
- Increased bearing life by offering enhanced protection.

### Design

The self-lubricating option utilizes self-lubricating attachments at both ends of the carriage and includes an initial EP2 grease pack of the carriage. The self-lubricating attachments consist of a section of oil saturated polymer actively compressed by a contact spring, inside a double lip seal.

A contact spring assures continuous contact with the rail, releasing oil as the carriage moves. This ensures a film of lubricant between the rolling elements and races. When the carriage is at rest, oil is re-absorbed by the polymer.

### Performance

The design has incorporated a proven oil-saturated polymer used for over 10 years to lubricate radial bearings. This method of lubrication has a successful track record in applications ranging from food processing to automotive assembly.

The graph below shows the theoretical L10 life expectancy and actual test results for the following two methods of lubrication:

1. Bearing with self-lubricating attachments only.
2. Bearing initially packed with EP2 grease only.

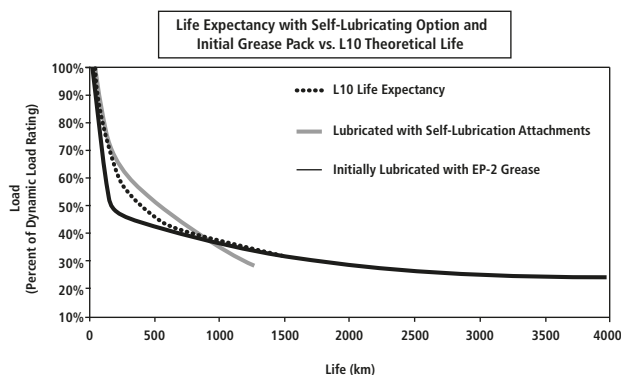

### Testing Parameters

Stroke: 500 mm

Speed: 0,6 m/s

This chart illustrates how using the self-lubricating option, which combines the self-lubricating attachments and initial grease pack, will enable the bearing to achieve the L10 life expectancy under all loading condition. Note that for travel lives exceeding 30,000 km, recharging or replacing of the self-lubricating polymer is recommended.

## Calculations for Bellows Cover Extended Length & Rail Length

### Given the Stroke and Distance Between Carriage Extremes

**Extremes:**  
Way Cover Extended Length (mm) = Stroke (mm) / (1-CR).  
After dividing, round number up to the next increment of 5 mm. This value is used as the length in the way cover part number when ordering.

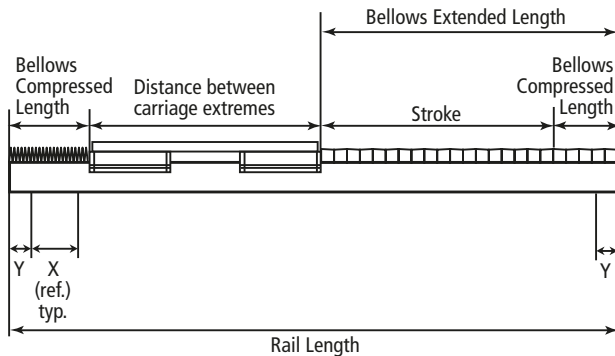

The Way Cover Extended Length will be cut to next vee at the factory.

Way Cover Compressed Length (mm) =  
Way Cover Extended Length (mm) - Stroke (mm).

Rail Length = Compressed Length + Extended Length + Distance Between Carriage Extremes.

### Example:

Product: 500 Series Ball Linear Guide Size 35

Stroke Length = 200 mm  
Distance Between Carriage Extremes = 520 mm  
Bellows Type = Walk-On  
CR = 0.19 for size 35 500 Series Ball Walk-on type bellows  
Way Cover Extended Length = Stroke /  
(1-CR) = 200 mm / (1-0.19) = 200 mm / .81 = 246.91 mm

Round up to next increment of 5 mm, therefore,  
Way Cover Extended Length = 250 mm  
Way Cover Compressed Length = Way Cover Extended Length - Stroke = 250 mm - 200 mm = 50 mm  
Rail Length = Compressed Length + Extended Length + Distance Between Carriage Extremes = 50 mm + 250 mm + 520 mm = 820 mm

## Butt Joint Specifications Sheet

### Specification Sheet for the Butting of Rails

A butt joint will be required for rail lengths longer than the maximum shown in the chart below. If a butt joint is required, the 1st and 2nd rail lengths must each be less than the maximum shown. The "Y1" and "Y2" dimensions must be between the minimum and maximum shown below to avoid cutting into a mounting hole. The standard "Z" dimension should be used for best performance.

Linear Guide Product	Size	"X" dim	Standard "Z" dim	Minimum "Y" dim	Maximum "Y" dim	Fastener size	Maximum length without a joint
500 Series Ball	15	60	60	8	52	M4	1 500
500 Series Ball	20	60	60	8	52	M5	3 000
500 Series Ball	25	60	60	8	52	M5	6 000
500 Series Ball	30	80	80	10	70	M8	6 000
500 Series Ball	35	80	80	10	70	M8	6 000
500 Series Ball	45	105	105	13	92	M12	6 000
500 Series Roller	25	30	30	8	52	M6	6 000
500 Series Roller	35	40	40	10	30	M8	6 000
500 Series Roller	45	52.5	52.5	13	39.5	M12	6 000
500 Series Roller	55	60	60	15	45	M14	6 000
500 Series Roller	65	75	75	17	58	M16	6 000

All dimensions in mm.

## Unit Conversion Table

Quantity	Conventional		SI Unit	Conversion Factors
	Inch Unit	Metric Unit (MKS)		
<b>Length</b>	Inch <b>in</b>	Meter <b>m</b>	Metre <b>m</b>	1 in = 25.4 mm 1 mm = 0.03937 in 1 m = 3.2808 ft 1 ft = 0.3048 m
<b>Area</b>	Square Inch <b>in<sup>2</sup></b>	Square Meter <b>m<sup>2</sup></b>	Square Metre <b>m<sup>2</sup></b>	1 in <sup>2</sup> = 6.4516 cm <sup>2</sup> 1 cm <sup>2</sup> = 0.155 in <sup>2</sup> 1 m <sup>2</sup> = 10.764 ft <sup>2</sup> 1 ft <sup>2</sup> = 0.092903 m <sup>2</sup>
<b>Mass</b>	Pound <b>lb<sub>m</sub></b>	Kilogram <b>kg</b>	Kilogram <b>kg</b>	1 lb <sub>m</sub> = 0.45359237 kg 1 kg = 2.2046 lb
<b>Force</b>	Pound Force <b>lb<sub>f</sub></b>	Kilogram Force <b>kg<sub>f</sub></b>	Newton <b>N</b>	1 lb <sub>f</sub> = 0.45359237 kg <sub>f</sub> 1 lb <sub>f</sub> = 4.44822 N 1 kg <sub>f</sub> = 2.2046 lb <sub>f</sub> 1 kg <sub>f</sub> = 9.80665 N 1 N = 0.1019716 kg <sub>f</sub> 1 N = 0.224809 lb <sub>f</sub>
<b>Stress or Pressure</b>	Pounds per Square Inch <b>lb<sub>f</sub>/in<sup>2</sup></b>	Kilograms per Square Meter <b>kg<sub>f</sub>/m<sup>2</sup></b>	Pascal <b>Pa</b>	1 MPa = 10 <sup>6</sup> N/m <sup>2</sup> = N/mm <sup>2</sup> 1 kPa = 10 <sup>3</sup> N/m <sup>2</sup> 1 lb <sub>f</sub> /in <sup>2</sup> = 0.070307 kg <sub>f</sub> /cm <sup>2</sup> 1 lb <sub>f</sub> /in <sup>2</sup> = 7.0307 x 10 <sup>-4</sup> kg <sub>f</sub> /mm <sup>2</sup> 1 lb <sub>f</sub> /in <sup>2</sup> = 6.8947 x 10 <sup>-3</sup> N/mm <sup>2</sup> (MPa) 1 kg <sub>f</sub> /cm <sup>2</sup> = 14.2233 lb <sub>f</sub> /in <sup>2</sup> 1 kg <sub>f</sub> /cm <sup>2</sup> = 9.80665 x 10 <sup>-2</sup> N/mm <sup>2</sup> (MPa)
<b>Torque or Work</b>	Inch Pounds <b>lb<sub>f</sub>-in</b>	Kilogram Meters <b>kg<sub>f</sub>-m</b>	Newton-Metres <b>Nm</b>	1 lb <sub>f</sub> -in = 1.1521 kg <sub>f</sub> -cm 1 kg <sub>f</sub> -cm = 0.8679 lb <sub>f</sub> -in 1 lb <sub>f</sub> -in = 0.1129848 Nm 1 kg <sub>f</sub> -m = 9.80665 Nm 1 kg <sub>f</sub> -cm = 9.80665 x 10 <sup>-2</sup> Nm 1 Nm = 8.85 lb <sub>f</sub> -in 1 Nm = 10.19716 kg <sub>f</sub> -cm
<b>Power</b>	Foot Pound per Minute <b>lb<sub>f</sub>-ft/min</b>	Force per Second <b>kg<sub>f</sub>-m/s</b>	Newton Metre per Second <b>Nm/s</b>	1 kW = 1000 Nm/s 1 kW = 60,000 Nm/s 1 kW = 44,220 lb <sub>f</sub> -ft/min 1 kW = 1.341 hp 1 hp = 75 kg <sub>f</sub> -m/s 1 hp = 44,741 Nm/min 1 hp = 33,000 lb <sub>f</sub> -ft/min 1 hp = 0.7457 kW
<b>Velocity</b>	Feet per Second <b>ft/s</b>	Meters per Second <b>m/s</b>	Metres per Second <b>m/s</b>	1 ft/sec = 0.3048 m/s 1 in/sec = 2.54 cm/s 1 ft/sec = 0.00508 m/s 1 mile/hr = 0.44704 m/s 1 km/hr = 0.27777 m/s 1 mile/hr = 1.609344 km/hr
<b>Acceleration</b>	Feet per Second Squared <b>ft/s<sup>2</sup></b>	Meters per Second Squared <b>m/s<sup>2</sup></b>	Metres per Second Squared <b>m/s<sup>2</sup></b>	1 ft/s <sup>2</sup> = 0.3048 m/s <sup>2</sup>

## Interchange Guide

THK HSR LM GUIDE TO THOMSON 500 SERIES BALL PROFILE RAIL INTERCHANGE SHEET	
THK HSR	THOMSON 500 SERIES BALL
<p><b>Assembly Part Number</b></p> $\frac{\text{HSR}}{1} \frac{20}{2} \frac{A}{3} \frac{2}{4} \frac{SS}{9} \frac{C1}{5} + \frac{1000}{7} \frac{P}{6}$	<p><b>Carriage Part Number</b></p> $\frac{(2) \text{ pcs}}{4} \frac{511}{1} \frac{P}{6} \frac{20}{2} \frac{A}{3} \frac{1}{5} \frac{Z}{9}$ <p>and</p> <p><b>Rail Part Number</b></p> $\frac{(1) \text{ pc}}{4} \frac{521}{1} \frac{P}{6} \frac{20}{2} \frac{A}{8} \frac{1000}{7}$
<p><b>Carriage Part Number</b></p> $\frac{\text{HSR}}{1} \frac{20}{2} \frac{A}{3} \frac{UU}{9}$	<p><b>Carriage Part Number</b></p> $\frac{511}{1} \frac{P}{6} \frac{20}{2} \frac{A}{3} \frac{1}{4}$
<p><b>Rail Part Number</b></p> $\frac{\text{HSR}}{1} \frac{20}{2} + \frac{1000L}{7}$	<p><b>Rail Part Number</b></p> $\frac{521}{1} \frac{P}{6} \frac{20}{2} \frac{A}{8} \frac{1000}{7}$

1. TYPE	
THK	THOMSON 500 SERIES BALL
Carriage - HSR Rail - HSR	Carriage - 511 Rail - 521
2. SIZE	
THK	THOMSON 500 SERIES BALL
15	15
20	20
25	25
30	30
35	35
45	45
55	N/A
3. CARRIAGE STYLE	
THK	THOMSON 500 SERIES BALL
A	A
B	A
CA	A
CB	A
LA	B
LB	B
HA	B
HB	B
R	E
TR	E
LR	F
HTR	F
4. CARRIAGES PER RAIL	

5. PRELOAD	
THK	THOMSON 500 SERIES BALL
blank	0
C1	1
C2	2
N/A	3
6. ACCURACY	
THK	THOMSON 500 SERIES BALL
blank	H
H	H
P	P
SP	U
UP	U
7. LENGTH	
THK	THOMSON 500 SERIES BALL
xxxxL	xxxx
8. RAIL STYLE	
THK	THOMSON 500 SERIES BALL
blank	A
K	U
N/A	C
9. SEALS	
THK	THOMSON 500 SERIES BALL
SS	blank
UU	blank
ZZ	Z
DD	W
KK	WZ
OZ	N
N/A	L

## Interchange Guide

STAR BALL RAIL SYSTEMS TO THOMSON 500 SERIES BALL INTERCHANGE SHEET	
STAR	THOMSON
<p><b>Carriage Part Number</b></p> $\frac{16}{1} \frac{51}{2} - \frac{8}{3} \frac{1}{4} \frac{2}{5} - \frac{10}{7}$	<p><b>Carriage Part Number</b></p> $\frac{511}{1} \frac{P}{5} \frac{20}{3} \frac{A}{2} \frac{1}{4}$
<p><b>Rail Part Number</b></p> $\frac{16}{1} \frac{05}{2} - \frac{8}{3} \frac{0}{5} \frac{2}{5} - 31, \frac{1000}{6}$	<p><b>Rail Part Number</b></p> $\frac{521}{1} \frac{P}{5} \frac{20}{3} \frac{A}{2} + \frac{1000}{6}$

1. TYPE		
	STAR	THOMSON
	16	Carriage - 511 Rail - 521
2. STYLE		
	STAR	THOMSON
CARRIAGE	03	B
	04	A
	21	E
	22	C
	23	D
	24	F
	51	A
	53	B
66	G	
RAIL	1605-X0X-XX	A + 531HP
	1605-X3X-XX	C + 531RCS (size 25 & up)
	1605-X6X-XX	C + 531RCS (size 25 & up)
	1607-XXX-XX	U
	1645-X03-XX	AD + 531HP
	1645-X33-XX	CD + 531RCS (size 25 & up)
	1647-X03-XX	UD

3. SIZE	
STAR	THOMSON
1	15
2	25
3	35
4	45
5	N/A
6	N/A
7	30
8	20
4. PRELOAD	
STAR	THOMSON
1	1
2	2
3	3
9	0
5. ACCURACY	
STAR	THOMSON
1	U
2	P
3	H
4	H
9	0
6. RAIL LENGTH	
STAR	THOMSON
XXXX	+XXXXX
7. REVISION	
STAR	THOMSON
10	blank
20	blank



STAR ROLLER RAIL SYSTEM TO THOMSON 500 SERIES ROLLER PROFILE RAIL INTERCHANGE SHEET	
STAR	THOMSON
<p><b>Carriage Part Number</b></p> $\frac{18}{1} \frac{51}{2} - \frac{2}{3} \frac{1}{4} \frac{2}{5} - \frac{10}{7}$	<p><b>Carriage Part Number</b></p> $\frac{512}{1} \frac{P}{5} \frac{20}{3} \frac{A}{2} \frac{1}{4}$
<p><b>Rail Part Number</b></p> $\frac{18}{1} \frac{05}{2} - \frac{2}{3} \frac{0}{8} \frac{2}{5} - \frac{31}{9}, \frac{1000}{6}$	<p><b>Rail Part Number</b></p> $\frac{522}{1} \frac{P}{5} \frac{25}{3} \frac{A}{2} + \frac{1000}{6}$

1. TYPE		
STAR	THOMSON	
18	Carriage - 512 Rail - 522	
2. STYLE		
STAR	THOMSON	
CARRIAGE	51	A
	53	B
	21	C
	24	D
Rail - see RAIL STYLE - 1, 2, 8 and 9 Section		
3. SIZE		
STAR	THOMSON	
2	25	
3	35	
4	45	
5	55	
6	65	
4. PRELOAD		
STAR	THOMSON	
1*	1	
2	2	
3	3	
5. ACCURACY		
STAR	THOMSON	
3	N/A	
2	P	
1	S	
9	U	

6. LENGTH	
STAR	THOMSON
XXXX	+XXXX
7. VERSION	
STAR	THOMSON
10 13 (ALUMINIUM END CAP) 18 60	blank N/A ES4 D-Thin Dense Chrome
RAIL STYLE 1,2,8 AND 9	
STAR	THOMSON
1805-x2x-31	C
1805-x3x-31	C + 532RCS (size 25)
1805-x3x-61	C + 532RCS (size 35 & up)
1805-x5x-31	A
1805-x6x-31	C + 532RCS (size 25)
1805-x6x-61	C + 532RCS (size 35 & up)
1806-x5x-31	A
1807-x0x-11	U
1845-x1x-31	A + Thin Dense Chrome
1845-x5x-31	C + Thin Dense Chrome + 532RCS (size 25)
1845-x5x-61	C + Thin Dense Chrome + 532RCS (size 35 & up)
1845-x8x-31	C + Thin Dense Chrome + 532RCS
1847-x1x-31	U + Thin Dense Chrome
18xx-xxx-41	Coated End for Thin Dense Chrome options in place of -31
18xx-xxx-71	Coated End for Thin Dense Chrome options in place of -61

**The Thomson 500 Series Ball Profile Rail replaces the Thomson AccuGlide Profile Rail.**

The 500 Series Ball Profile Rail provides the following advantages when compared to AccuGlide:

- Increased rail straightness through advanced grinding technologies
- Simpler installation and greater accuracy on joint-free rails up to 6 meters long
- Smoother, quieter movement through insert molded recirculation paths, minimized transitions and optimized geometries
- Increased load capacity from longer ball paths and total number of rolling elements
- On-site field modifiable and upgradeable easy-to-use modular carriage and seal designs
- Customization with expanded accessories offering

THOMSON AccuGlide* TO THOMSON 500 SERIES BALL PROFILE RAIL INTERCHANGE SHEET	
THOMSON AccuGlide*	THOMSON 500 SERIES BALL
<b>Assembly Part Number</b> CG 20 AA B P 1 2 3 4 5 8	<b>Carriage Part Number</b> 511 P 20 A 1 1 5 2 3 4 8
<b>Rail Part Number</b> RG 20 P L1000 1 2 5 6 8	<b>Rail Part Number</b> 521 P 20 A 1000 1 5 2 7 8 6

1. TYPE	
AccuGlide	THOMSON 500 SERIES BALL
Carriage - CG Rail - RG	Carriage - 511 Rail - 521
2. SIZE	
AccuGlide	THOMSON 500 SERIES BALL
15 20 25 30 35 45 55	15 20 25 30 35 45 N/A
3. CARRIAGE STYLE	
AccuGlide	THOMSON 500 SERIES BALL
AA BA CE DE EE HE	A B C D E F
4. PRELOAD	
AccuGlide	THOMSON 500 SERIES BALL
A B C D	0 1 2 3

5. ACCURACY	
AccuGlide	THOMSON 500 SERIES BALL
N H P S U	H H P U U
6. LENGTH	
AccuGlide	THOMSON 500 SERIES BALL
Lxxxx	xxxx
7. RAIL STYLE	
AccuGlide	THOMSON 500 SERIES BALL
- N/A N/A	A U C
8. OPTIONS <sup>1</sup>	
AccuGlide	THOMSON 500 SERIES BALL
A C2C2 (plastic) C3C3 D### KK LDS LL M### R2R2 ZZ N/A N/A	D C (steel) C See pg. 132 or Consult Thomson W Standard Longitudinal Seal is low drag L See pg. 132 or Consult Thomson E Z V (Viton Wiper) N (Oil Reservoir)

**The Thomson 500 Series Roller Profile Rail replaces the Thomson AccuMax Profile Rail**

The 500 Series Roller Profile Rail provides the following advantages when compared to AccuMax:

- Increased rail straightness through advanced grinding technologies
- Simpler installation and greater accuracy on joint-free rails up to 6 meters long
- Smoother, quieter movement through insert molded recirculation paths, minimized transitions and optimized geometries
- Increased load capacity from longer roller paths and total number of rolling elements
- Expanded offering of ultra-rigid roller carriage sizes and styles for all applications
- On-site field modifiable and upgradeable easy-to-use modular carriage and seal designs
- Customization with expanded accessories offering

THOMSON AccuMax* TO THOMSON 500 SERIES ROLLER PROFILE RAIL INTERCHANGE SHEET	
THOMSON AccuMAX*	THOMSON 500 SERIES ROLLER
<b>Assembly Part Number</b> CM $\frac{35}{1}$ AA $\frac{B}{3}$ $\frac{S}{4}$ $\frac{5}{5}$ $\frac{8}{8}$	<b>Carriage Part Number</b> $\frac{512}{1}$ $\frac{S}{5}$ $\frac{35}{2}$ $\frac{A}{3}$ $\frac{1}{4}$ $\frac{8}{8}$
<b>Rail Part Number</b> RM $\frac{35}{1}$ $\frac{S}{2}$ $\frac{L1000}{5}$ $\frac{6}{6}$ $\frac{8}{8}$	<b>Rail Part Number</b> $\frac{522}{1}$ $\frac{S}{5}$ $\frac{35}{2}$ $\frac{A}{7}$ $\frac{8}{8}$ $\frac{1000}{6}$

1. TYPE	
AccuMax	THOMSON 500 SERIES ROLLER
Carriage - CM Rail - RM	Carriage - 512 Rail - 522
2. SIZE	
AccuMax	THOMSON 500 SERIES ROLLER
N/A	25
35	35
45	45
55	55
N/A	65
3. CARRIAGE STYLE	
AccuMax	THOMSON 500 SERIES ROLLER
AA	A
N/A	B
N/A	C
N/A	D
4. PRELOAD	
AccuMax	THOMSON 500 SERIES ROLLER
B	1
C	2
D	3

5. ACCURACY	
AccuMax	THOMSON 500 SERIES ROLLER
P S U	P S U
6. LENGTH	
AccuMax	THOMSON 500 SERIES ROLLER
Lxxxx	xxxx
7. RAIL STYLE	
AccuMax	THOMSON 500 SERIES ROLLER
- N/A N/A	A U C
8. OPTIONS <sup>1</sup>	
AccuMax	THOMSON 500 SERIES ROLLER
A C2C2 (plastic) C3C3 D### KK LDS LL M### R2R2 ZZ N/A	D C (steel) C See pg. 132 or Consult Thomson W Standard Longitudinal Seal is low drag L See pg. 132 or Consult Thomson E Z V (Viton Wiper)

THK SHS LM GUIDE TO THOMSON 400 SERIES BALL CAGE PROFILE RAIL INTERCHANGE SHEET	
THK SHS	THOMSON 400 SERIES
<p><b>Assembly Part Number</b></p> $\frac{\text{SHS}}{1} \frac{25}{2} \frac{\text{LC}}{3} \frac{2}{4} \frac{\text{DD}}{9} \frac{\text{C1}}{5} + \frac{1200\text{L}}{7} \frac{\text{H}}{6}$	<p><b>Carriage Part Number</b></p> $\frac{(2)}{4} \text{ pcs } \frac{413^*}{1} \frac{\text{H}}{6} \frac{25}{2} \frac{\text{B}}{3} \frac{1}{5} \frac{\text{W}}{9}$ <p>and</p> <p><b>Rail Part Number</b></p> $\frac{(1)}{4} \text{ pc } \frac{421}{1} \frac{\text{H}}{6} \frac{25}{2} \frac{\text{A}}{8} \frac{1200}{7}$
<p><b>Carriage Part Number</b></p> $\frac{\text{SHS}}{1} \frac{25}{2} \frac{\text{LC}}{3} \frac{2}{4} \frac{\text{SS}}{9} \frac{\text{C1}}{5} \frac{\text{H}}{6} \text{ (GK) BLOCK}$	<p><b>Carriage Part Number</b></p> $\frac{413^*}{1} \frac{\text{H}}{6} \frac{25}{2} \frac{\text{B}}{3} \frac{1}{5}$
<p><b>Rail Part Number</b></p> $\frac{\text{SHS}}{1} \frac{25}{2} \frac{-1200\text{L}}{7} \frac{\text{H}}{6} \text{ (GK) RAIL}$	<p><b>Rail Part Number</b></p> $\frac{421}{1} \frac{\text{H}}{6} \frac{25}{2} \frac{\text{A} + 1000}{8} \frac{7}{7}$

1. TYPE	
THK	THOMSON 400 SERIES
Carriage - SHS	Carriage - 413*
Rail - SHS	Rail - 421
2. SIZE	
THK	THOMSON 400 SERIES
15	15
20	20
25	25
30	30
35	35
45	45
55	55
65	N/A
3. CARRIAGE STYLE	
THK	THOMSON 400 SERIES
C	A
LC	B
V	C
LV	D
R	E
LR	F
4. CARRIAGES PER RAIL	

\* Thomson 400 Series carriages are available in both Ball (411) and Ball cage (413) design whereas, THK SHS carriages are only available in cage design. Thomson 400 Series Ball carriages can be substituted for THK SHS carriages if the application does not require low noise at high speeds. Ball carriages are more economical and dimensionally interchangeable to THK SHS carriages. When selecting the carriage type, 413 can be replaced by 411 to change from ball cage to ball type.

5. PRELOAD	
THK	THOMSON 400 SERIES
blank	0
C1	1
C0	N/A
6. ACCURACY	
THK	THOMSON 400 SERIES
blank	N
H	H
7. LENGTH	
THK	THOMSON 400 SERIES
xxxxL	xxxx
8. RAIL STYLE	
THK	THOMSON 400 SERIES
blank	A
K	U
9. SEALS	
THK	THOMSON 400 SERIES
UU	blank (standard)
SS	blank (standard)
DD	W
ZZ	Z
KK	WZ

**Common AccuGlide Options**

Carriage Options	500 Series Option
C2C2	C
C3C3	C
D035	ES1
D047	ES10*
D065	ES2
D086	ES1ES10*
D087	ES8 or ES1ES10*
D088	ES2ES10*
D089	ES9 or ES2ES10*
D134	ZCES1
D135	CES1
D147	CES10*
D150	ZC
D164	ZCES2
D165	CES2
D186	CES1ES10*
D187	CES7 or CES10*
D188	CES10*
D189	CES9 or CES2ES10*
D192	LCES9 or LCES2ES10*
D234	LES1
D235	LZES1
D236	LZCES1
D237	LCES1
D241	LC
D251	LZC
D262	LES2
D263	LCES2
D264	ZES2
D265	LZES2
D266	LZCES2
D267	LCES2
D274	LES12
D275	LZES12
D289	LES9 or LES2ES10*
D292	LZES9 or LZES2ES10*
LDS	now standard
LL	L
LLZZ	LZ
M035	ES3
M038	CES3
M041	1/4-28 in side options: ES7 or ES10 option*
M043	C + 1/4-28 in side options: CES7 or CES10 option*
M047	ES7 or ES10*
M049	CES7 or CES10*
M063	CES4
M065	ES4
M075	ES14
M077	ES14 + ES7
M087	ES5
M088	ES4ES10
M089	ES6
M094	ES7 + ES15
M095	ES15

Carriage Options	500 Series Option
M097	ZES15
M099	CES15
M125	ES11
M134	ES6
M147	CES7
M153	W
M157	WZ
M168	Duralloy
M171	Z
M183	ZES5
M186	ES5
M187	CES5
M188	CES10*
M189	CES6
M192	ZES6
M209	LES6
M210	WES7
M234	LES3
M235	LZES3
M236	LZCES3
M241	LC
M242	Duralloy + L
M249	LCES7 or LCES10*
M251	LZC
M263	LES4
M264	ZES4
M265	LZES4
M266	LZCES4
M267	LCES4
M275	LZES14G1
M287	LES5
M289	LES6
M290	LCES6
M292	LZES6
M293	WES5
M294	GS
ZZ	Z

\* ES10 option is side lube in end cap, size 15=M3, size 20 and up=M6.

Rail Options	500 Series Designation
D080	DH1
D085	DH2
D181	EDH1
D185	EDH2
D187	EDH2
M080	DH3
M082	EDH3
M083	EDH3
M085	DH4
M088	EDH4
M091	EDH4
R2R2	E
R3R3	E

**NOTES:**

A large grid of graph paper, consisting of 20 columns and 30 rows of small squares, intended for taking notes.

**NOTES:**

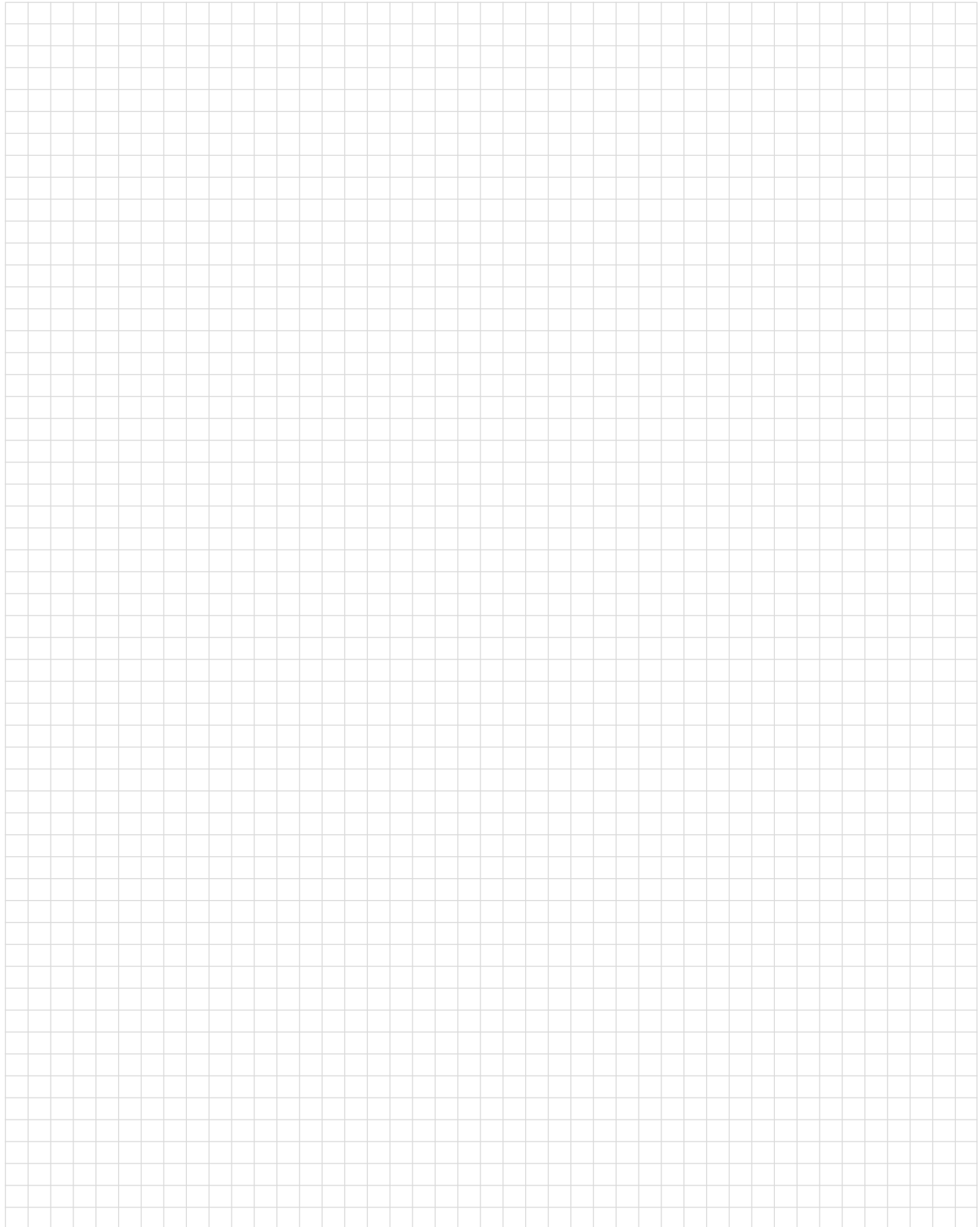

**NOTES:**

A large grid of graph paper, consisting of 20 columns and 40 rows of small squares, intended for taking notes.



**NOTES:**

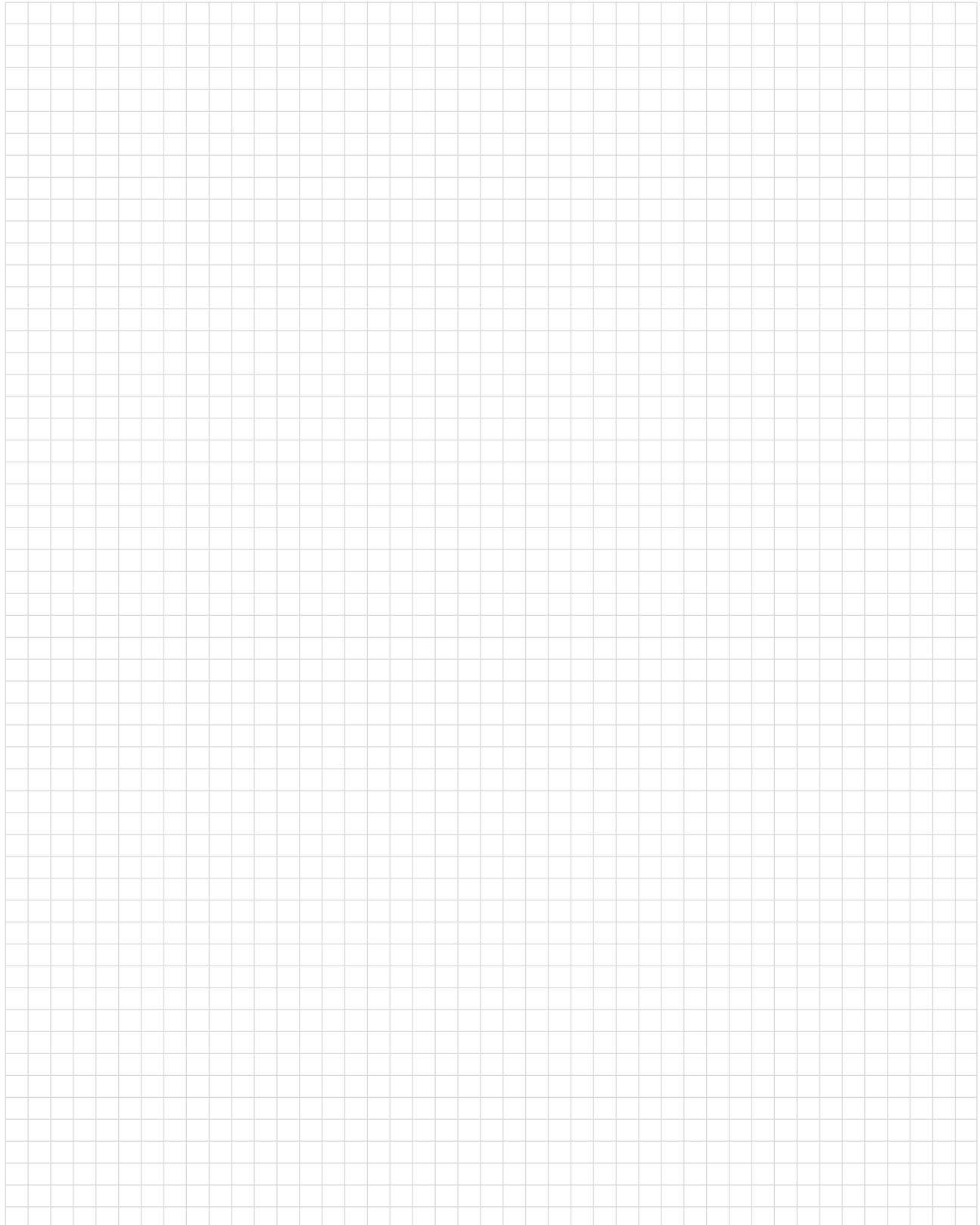

**NOTES:**

A large grid of graph paper, consisting of 20 columns and 40 rows of small squares, intended for taking notes.

# Thomson 400 Series Express

*Genuine Thomson 400 Series profile rail linear guides and rails delivered fast.*

Thomson now stocks the most popular 400 Series SKUs, ready for same and next day shipment from our Marengo, IL, facility.

**Get the real thing, real fast!**



PART NUMBER	DESCRIPTION
411N15A0	400 SERIES BALL STANDARD FLANGED CARRIAGE
411N15C0	400 SERIES BALL STANDARD NARROW CARRIAGE
411N20A0	400 SERIES BALL STANDARD FLANGED CARRIAGE
411N20C0	400 SERIES BALL STANDARD NARROW CARRIAGE
411N25A0	400 SERIES BALL STANDARD FLANGED CARRIAGE
411N25C0	400 SERIES BALL STANDARD NARROW CARRIAGE
411N30A0	400 SERIES BALL STANDARD FLANGED CARRIAGE
411N35C0	400 SERIES BALL STANDARD NARROW CARRIAGE
421N15ARL4000	400 SERIES STANDARD BALL RAIL W/THROUGH HOLES, TOP MOUNTED
421N20ARL4000	400 SERIES STANDARD BALL RAIL W/THROUGH HOLES, TOP MOUNTED
421N25ARL4000	400 SERIES STANDARD BALL RAIL W/THROUGH HOLES, TOP MOUNTED
421N30ARL4000	400 SERIES STANDARD BALL RAIL W/THROUGH HOLES, TOP MOUNTED
421N35ARL4000	400 SERIES STANDARD BALL RAIL W/THROUGH HOLES, TOP MOUNTED

- Maximum Express order sizes are 50 carriages and/or 25 rails.
- All Express orders are for standard, off-the-shelf and non-modified products.

## THOMSON USA, MEXICO & CANADA

Phone: 1-540-633-3549

Fax: 1-540-633-0294

E-mail: [thomson@thomsonlinear.com](mailto:thomson@thomsonlinear.com)



*Linear Motion. Optimized.*

## **USA, CANADA and MEXICO**

Thomson  
203A West Rock Road  
Radford, VA 24141, USA  
Phone: 1-540-633-3549  
Fax: 1-540-633-0294  
E-mail: [thomson@thomsonlinear.com](mailto:thomson@thomsonlinear.com)  
Literature: [literature.thomsonlinear.com](http://literature.thomsonlinear.com)

## **EUROPE**

### **United Kingdom**

Thomson  
Office 9, The Barns  
Caddsdow Business Park  
Bideford  
Devon, EX39 3BT  
Phone: +44 (0) 1271 334 500  
E-mail: [sales.uk@thomsonlinear.com](mailto:sales.uk@thomsonlinear.com)

### **Germany**

Thomson  
Nürtinger Straße 70  
72649 Wolfschlügen  
Phone: +49 70 22 504 403  
Fax: +49 70 22 504 405  
E-mail: [sales.germany@thomsonlinear.com](mailto:sales.germany@thomsonlinear.com)

### **France**

Thomson  
Phone: +33 (0) 243 50 03 30  
Fax: +33 (0) 243 50 03 39  
E-mail: [sales.france@thomsonlinear.com](mailto:sales.france@thomsonlinear.com)

### **Italy**

Thomson  
Largo Brughetti  
20030 Bovisio Masciago  
Phone: +39 0362 594260  
Fax: +39 0362 594263  
E-mail: [sales.italy@thomsonlinear.com](mailto:sales.italy@thomsonlinear.com)

### **Spain**

Thomson  
E-mail: [sales.esm@thomsonlinear.com](mailto:sales.esm@thomsonlinear.com)

### **Sweden**

Thomson  
Estridsväg 10  
29109 Kristianstad  
Phone: +46 (0) 44 24 67 00  
Fax: +46 (0) 44 24 40 85  
E-mail: [sales.scandinavia@thomsonlinear.com](mailto:sales.scandinavia@thomsonlinear.com)

## **ASIA**

### **Asia Pacific**

Thomson  
E-mail: [sales.apac@thomsonlinear.com](mailto:sales.apac@thomsonlinear.com)

### **China**

Thomson  
Rm 2205, Scitech Tower  
22 Jianguomen Wai Street  
Beijing 100004  
Phone: +86 400 6661 802  
Fax: +86 10 6515 0263  
E-mail: [sales.china@thomsonlinear.com](mailto:sales.china@thomsonlinear.com)

### **India**

Thomson  
c/o CNRG Energy India Pvt. Ltd.  
Unit No. FF A 07  
Art Guild House, A Wing, 1st Floor, L.B.S Marg  
Kurla – West, Mumbai – 400070 India  
Phone: +0091 22 6249 5043  
E-mail: [sales.india@thomsonlinear.com](mailto:sales.india@thomsonlinear.com)

### **Japan**

Thomson  
Minami-Kaneden 2-12-23, Suita  
Osaka 564-0044 Japan  
Phone: +81-6-6386-8001  
Fax: +81-6-6386-5022  
E-mail: [csjapan@scgap.com](mailto:csjapan@scgap.com)

### **Korea**

Thomson  
F7 Ilsong Bldg, 157-37  
Samsung-dong, Kangnam-gu,  
Seoul, Korea (135-090)  
Phone: +82 2 6917 5049  
Fax: +82 2 528 1456  
E-mail: [sales.korea@thomsonlinear.com](mailto:sales.korea@thomsonlinear.com)

## **SOUTH AMERICA**

### **Brazil**

Thomson  
Av. Tamboré, 1077  
Barueri, SP – 06460-000  
Phone: +55 (11) 3616-0191  
Fax: +55 (11) 3611-1982  
E-mail: [sales.brasil@thomsonlinear.com](mailto:sales.brasil@thomsonlinear.com)