

UHF RFID System

V780 Series

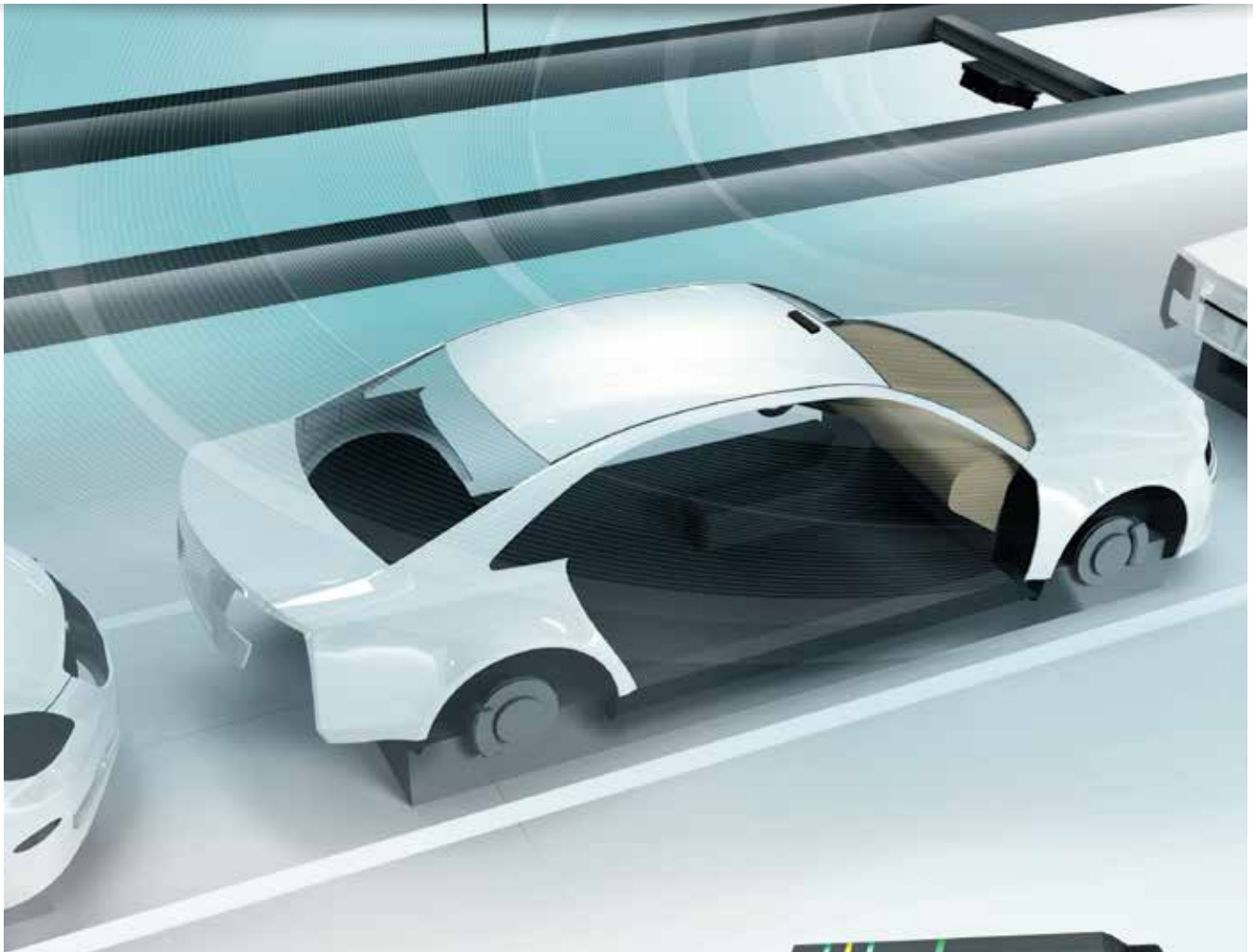

Long range reader/writer accurately tracks mixed model production



Identify products over a wide range of distances

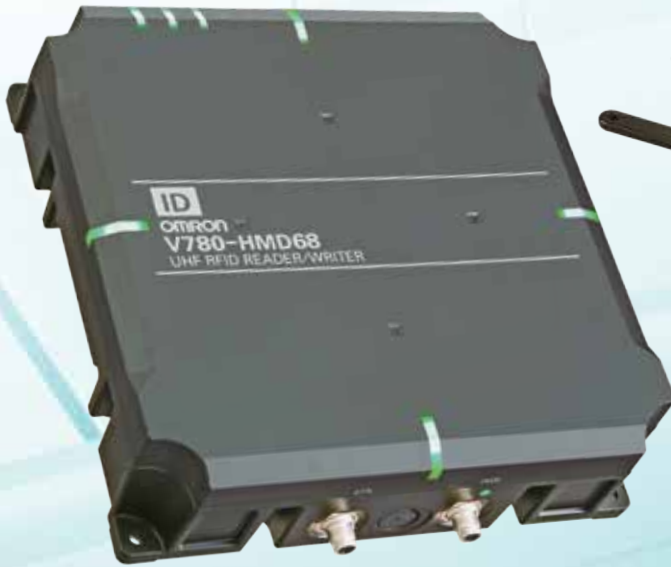

UHF RFID System
V780 Series





Increasing high-mix low-volume production and modular production lines

Challenges when introducing RFID

V780 Series

Install into high-mix production lines

Reliable RF tag reading from several meters away
Identify products where the RFID tag can vary widely in read distance

p.4

Quickly install and tune

Patented features to speed deployment
Can be deployed with minimal RFID training

p.5

Make troubleshooting easy

Extensive data logging features to evaluate long term performance
Helps reduce troubleshooting time

p.6

The video shows details of each function <http://www.fa.omron.co.jp/v780e>



Stable communications even in high-mix production lines

Reliable long distance communications

Identify products at varying distances

The UHF band means products can be at varying read distances with no effect on read rates.

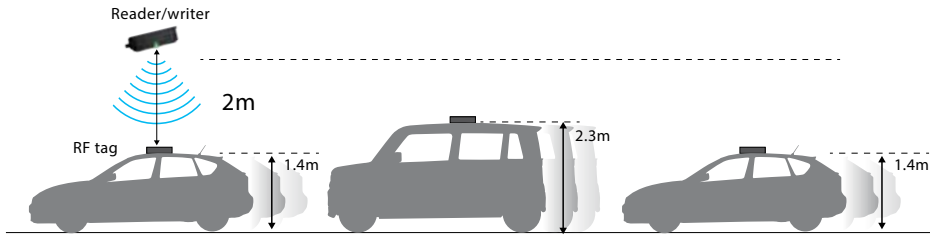

Focus Mode prevents misreads and reads only target tags **PATENT PENDING**

Focus mode allows the V780 to read only the target RFID tag and ignore others within its range.



Multi-Reader/Writer function* for high-mix production

This function enables up to eight reader/writers to communicate as if they are one reader/writer. When a wider communication range is required (e.g., checking all stacked pallets with an RF tag at the same time), multiple reader/writers can be installed one above the other to cover the required communication range. The host device sends commands only to the master reader/writer to communicate.

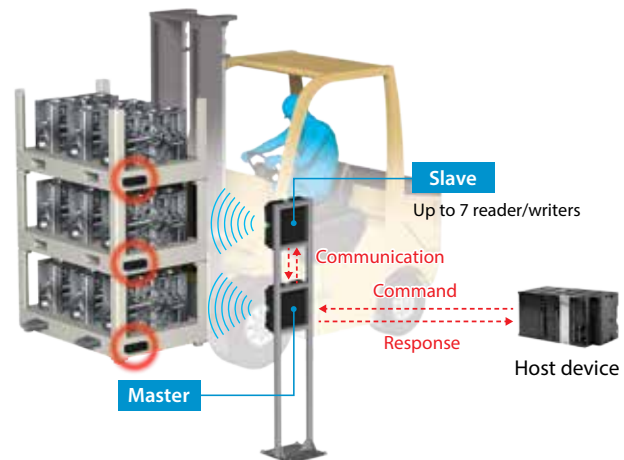

*.Version 3 or later provides this function.

Features that speed deployment and maximize reliability

Automatic transmission power tuning

The transmission power required for communications between the reader/writer and RF tags are measured and automatically set to appropriate values. The set power will be large enough to communicate with RF tags and minimize interference with other reader/writers. This function is useful when multiple reader/writers are installed in one factory. The transmission power can be easily set via the web browser.

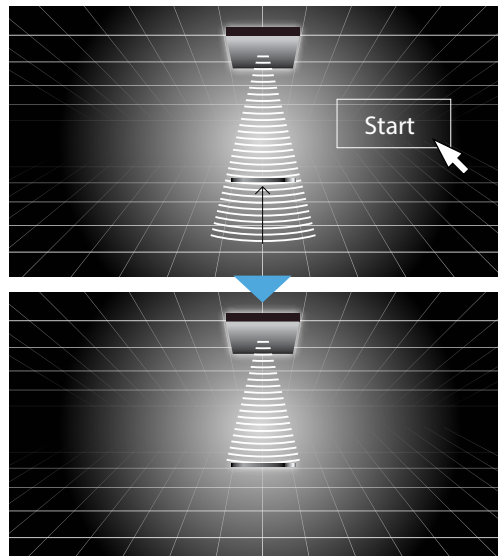

Power is tuned to the target RF tag, which reduces installation and adjustment time

Reception Level Monitor shows reception levels over time for installation/adjustment

This function visualizes reception levels, helping adjust installation positions of reader/writers and RF tags and check communication ranges.

When RF tags on two or more objects are read for adjustment, connect your PC with the reader/writer to check a time series graph of the reception levels via the web browser.

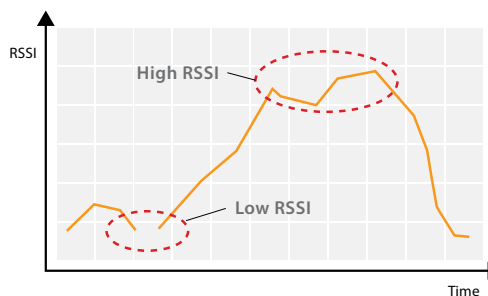

LED indicators help you adjust installation positions

In addition to the web browser, the flashing speed of the LED indicators on the reader/writer provides a visual indication of the reception level. This makes it easier to install and adjust a reader/writer or RF tag at a production site.



Check the reception level with the indicators on the reader/writer to find the best installation position of an RF tag

Continuous monitoring of system performance

Diagnostic tools to maximize uptime

Monitor communication status via the web browser

By connecting a PC, parameters can be set, communication status, noise levels, and communication logs can be monitored via a web browser. This facilitates maintenance and troubleshooting

• RF communications diagnostics log (displayed as a list or graph)

The last 8,000 diagnostic points are saved for analysis. If the system becomes unstable, probable causes and workarounds are displayed to make troubleshooting easier. Also, a graph displaying Received Signal Strength Indication (RSSI) levels and noise levels are available for help in identifying the causes. These diagnostic results can also be output to a .CSV file.

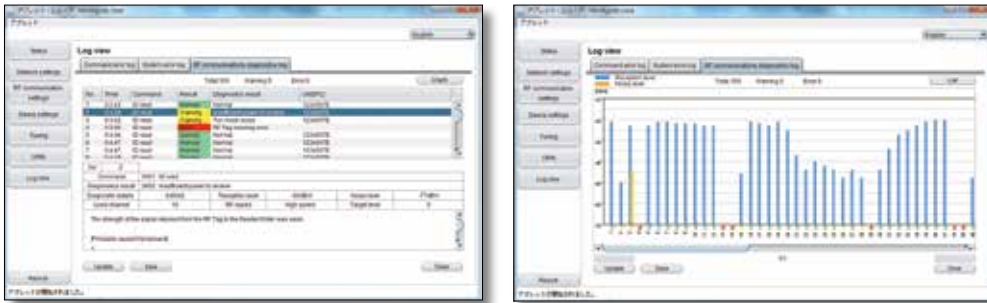

• Channel monitor

Noise levels in the operating environment are displayed to allow monitoring. Noise sources can then be identified and action taken.

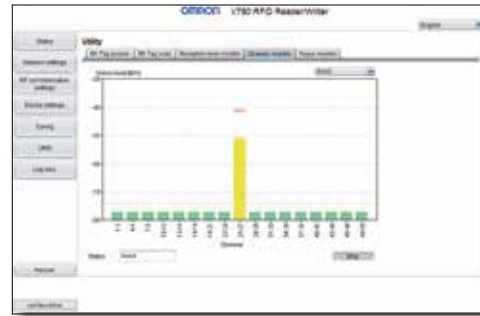

Real-time communication status indication

The status of the reader/writer can be quickly determined, even from a distance, by viewing the high brightness LED indicators.

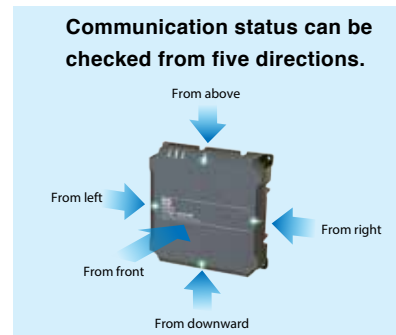
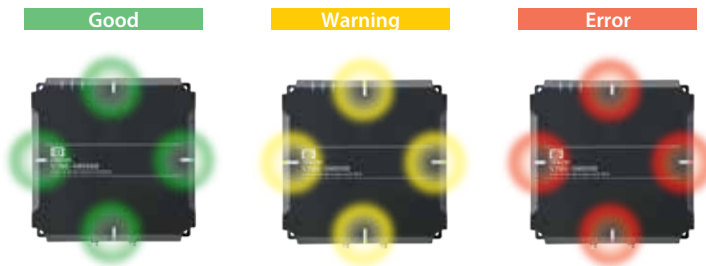

Applications

Automotive

Suitable for a mixed model production strategy

The wide communication range and focus mode enable automotive chassis to be reliably detected from several meters away.



Part tracking and management

Accurately supply parts even in high-mix production

Track part pallets and racks through production. Bright LEDs give operators indication of good reads.

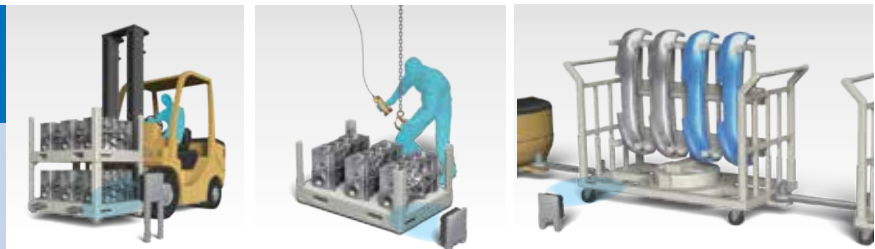

Material handling

Identify product for conveyor diverters and sortation systems

Identify work in process product in harsh environments where bar code readers or vision can not be applied.

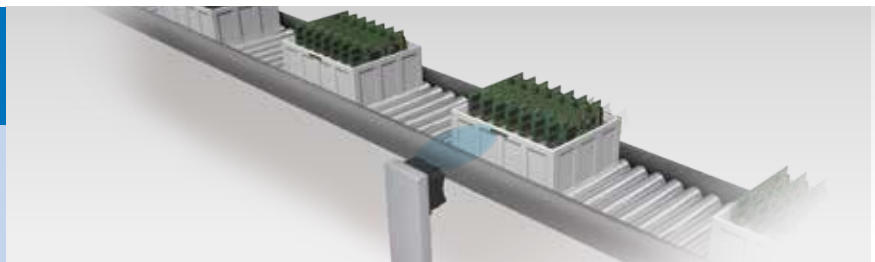

Hanging conveyance

Identify product while the read distance changes due to conveyance method

Product can be identified while moving and without line of sight from the tag to the V780 reader.



Error proofing

Make sure the correct raw material or assembly is used in production.

Product going into machine areas or dock portals can be identified with up to 64 unique RFID tags in one read.

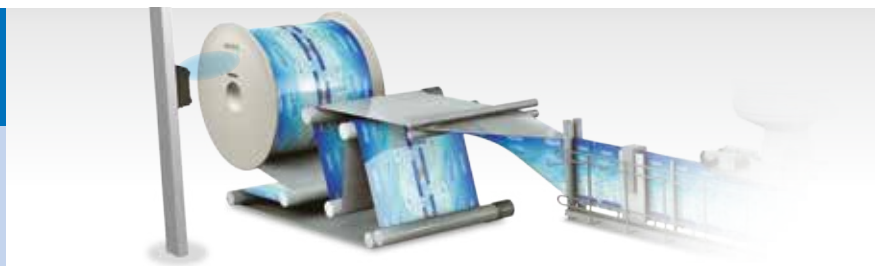

Regulations for UHF wireless (radio regulations) will be complied with

RFID systems as well as mobile phones and TVs must comply with national radio regulations. The V780 Series currently complies with radio regulations in many countries and will comply with them in other countries. For the list of countries where the V780 is available, please contact your Omron representative or visit our website: <http://www.ia.omron.com/>.

System configurations

When connecting one reader/writer to host device

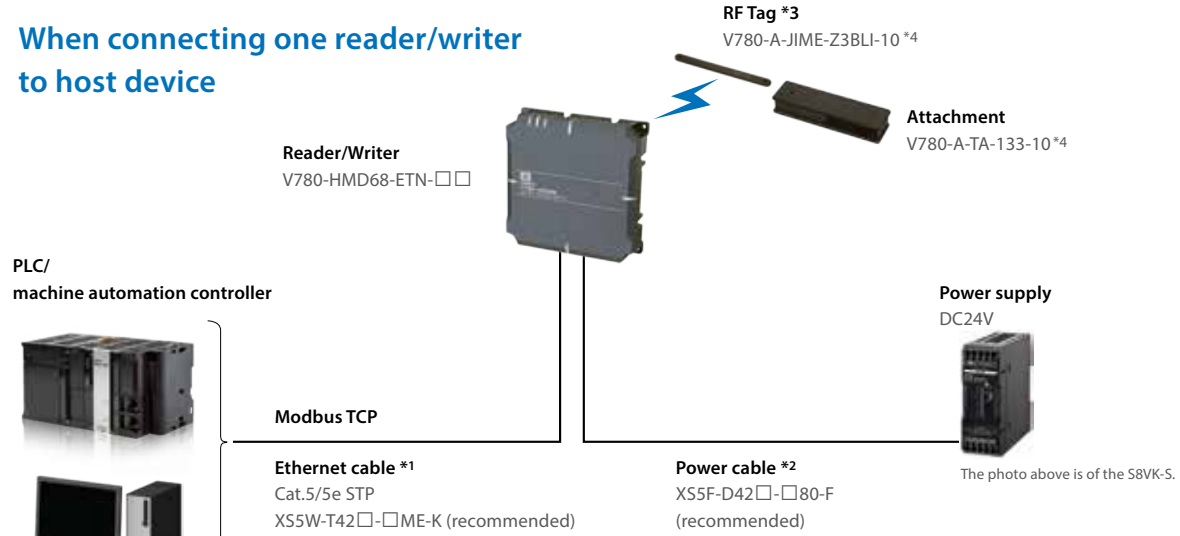

PC

- *1. The maximum extension length of the Ethernet cable is 100 m.
- *2. The maximum extension length of the power cable is 60 m.
- *3. The RF tags that conform to ISO/IEC 18000-63 (ISO/IEC 18000-6 Type C) can be used.
- *4. Contains 10 RF Tag Attachments per package.

When connecting two or more reader/writers to host device

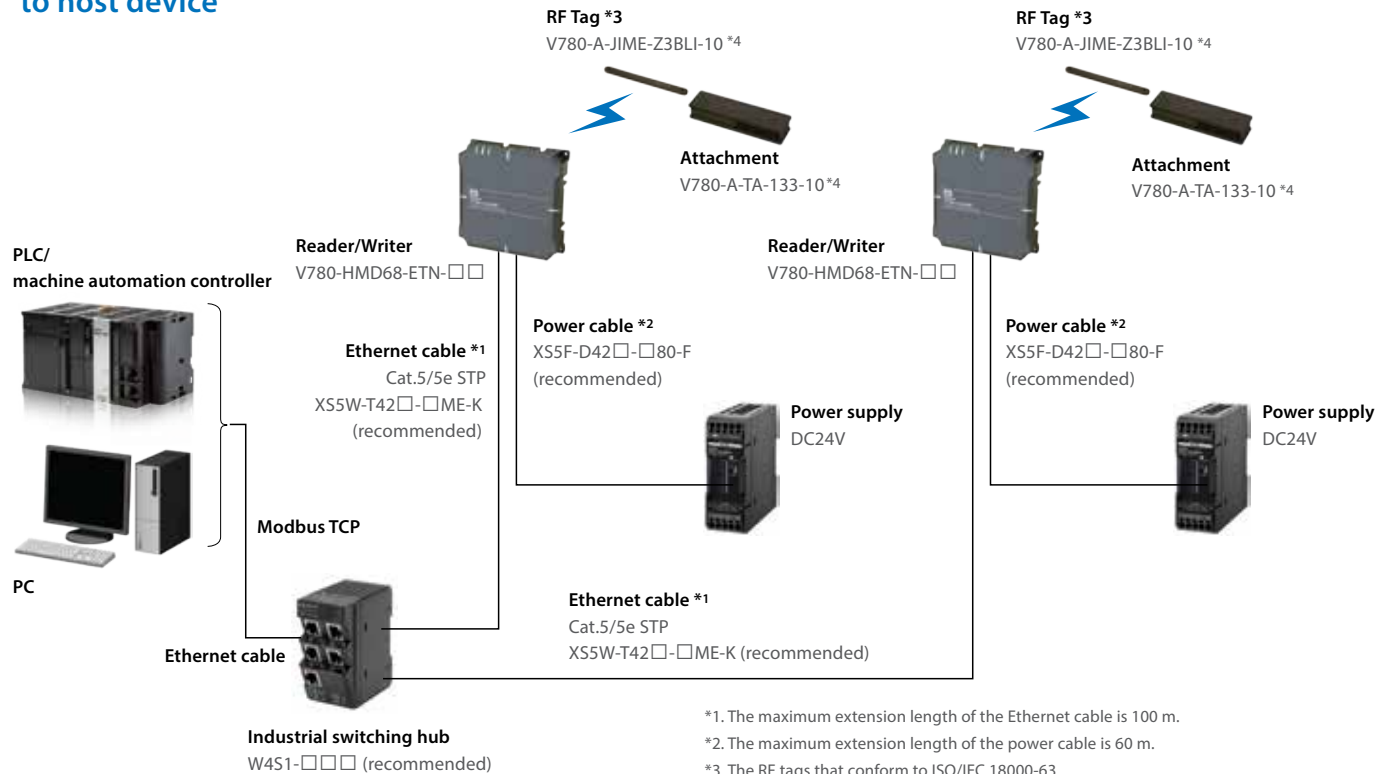

PC

- *1. The maximum extension length of the Ethernet cable is 100 m.
- *2. The maximum extension length of the power cable is 60 m.
- *3. The RF tags that conform to ISO/IEC 18000-63 (ISO/IEC 18000-6 Type C) can be used.
- *4. Contains 10 RF Tag Attachments per package.

Note. The maximum number of reader/writers that can be connected to the Ethernet port depends on the host device. Contact your Omron representative for details.

UHF RFID System V780 Series

3 in 1 UHF RFID System: Antenna, Amplifier & Controller

- Conforms to ISO/IEC 18000-63: 2013
- Long range and stable communications
- Reader/writer with integrated antenna
- Communications status visualized by LED indicators
- Host communications: Ethernet (Modbus/TCP base)
- Simple and easy to use



 Refer to the *Safety Precautions and Precautions for Correct Use* in the User's Manual.

Ordering Information

Reader/Writer

Appearance	Size (mm)	Network	Applicable countries *	Model
	250 × 250 × 70	Modbus/TCP base (TCP/IP)	United States and Canada	V780-HMD68-ETN-US
			Mexico	V780-HMD68-ETN-MX

* Contact your Omron representative for details on products for other countries.

RF Tag

Appearance	Memory capacity	Size (mm)	Model
	1 Kword	150 × 14 × 6	V780-A-JIME-Z3BLI-10 *

* Contains 10 RF Tags per package.

RF Tag Attachment

Appearance	Material	Size (mm)	Model
	Polycarbonate plastic	180 × 50 × 30	V780-A-TA-133-10 *

* Contains 10 RF Tag Attachments per package.

- Note:**
1. Use the RF Tag Attachment when mounting on metal surface. Refer to the User's Manual for how to mount.
 2. Toppan Forms Co., Ltd. manufactures RF Tags and Attachments. For more information, visit the following website:
<http://www.toppan-f.co.jp/english/>

V780 Series

Cables

Recommended Ethernet Cables (Connection between Host Device and Reader/Writer)

Use STP (shielded twisted-pair) cable of category 5 or higher.

Specifications	Cable length (m) *	Model	
Wire Gauge and Number of Pairs: AWG22, 2-pair Cable	Cable with Plug on One End and Socket on Other End (M12 Straight/RJ45)	0.5	XS5W-T421-BME-K
		1	XS5W-T421-CME-K
		2	XS5W-T421-DME-K
		5	XS5W-T421-GME-K
		10	XS5W-T421-JME-K

* 3- and 15-m cables are also available.

Note: For details, refer to the *Industrial Ethernet Connectors Catalog* (Cat. No. G019).

Other cable lengths, robot cables, and extension cables are available. Contact your Omron representative for details.

Recommended Power Cables (Connection between Power Supply and Reader/Writer)



XS5F-D42@-@80-F

Specifications	Cable length (m)	Cable outer diameter (mm)	Straight Connectors	Angled Connectors
			Model	Model
Fire-retardant, Robot Cable	1	6	XS5F-D421-C80-F	XS5F-D422-C80-F
	2		XS5F-D421-D80-F	XS5F-D422-D80-F
	3		XS5F-D421-E80-F	XS5F-D422-E80-F
	5		XS5F-D421-G80-F	XS5F-D422-G80-F
	10		XS5F-D421-J80-F	XS5F-D422-J80-F

Note: For details, refer to the XS5 datasheet (<http://www.ia.omron.com/>).

Other cable lengths and extension cables are available. Contact your Omron representative for details.

Recommended Industrial Switching Hubs

Appearance	Specifications			Model
	Functions	No. of ports	Failure detection	
	Quality of Service (QoS): EtherNet/IP control data priority Failure detection: Broadcast storm and LSI error detection 10/100BASE-TX, Auto-Negotiation	3	No	W4S1-03B
		5	No	W4S1-05B
		5	Yes	W4S1-05C

Ratings and Performance

Reader/Writer

General Specifications

Item	V780-HMD68-ETN-□□
Dimensions	250 × 250 × 70 mm (D × H × W, excluding protruding parts and cables)
Supply voltage	24 VDC (-15% to +10%)
Power consumption	10 W max.
Ambient operating temperature	-10 to 55°C (with no icing)
Ambient operating humidity	25% to 85% (with no condensation)
Ambient storage temperature	-25 to 70°C (with no icing)
Ambient storage humidity	25% to 85% (with no condensation)
Insulation resistance	20 MΩ min. (at 500 VDC) between cable terminals and case
Dielectric strength	1,000 VAC, 50/60 Hz for 1 min between cable terminals and case
Vibration resistance	No abnormality after application of 10 to 500 Hz, double amplitude: 1.5 mm, acceleration: 100 m/s ² , 10 sweeps in each of 3 axis directions (up/down, left/right, and forward/backward) for 11 minutes each
Shock resistance	No abnormality after application of 500 m/s ² , 3 times each in 6 directions (Total: 18 times)
Degree of protection	IP54 (IEC 60529:2001)
Materials	Plastic case: PBT Metal case: Die-cast aluminum (ADC12)
Weight	Approx. 3 kg
Mounting method	Four M6 bolts
Host communications interface	Ethernet 10BASE-T/100BASE-TX
Host communications protocol	Modbus/TCP base
Accessories	Instruction Sheet (1), IP address label (1), Startup Guide (1), Ferrite core (2) *1, and EU DECLARATION OF CONFORMITY (1) *2
Regulations	See <i>Regulations</i> on page 11 for the regulations.

*1. A ferrite core is packaged with Model V780-HMD68-ETN-EU/-IN.

*2. A EU DECLARATION OF CONFORMITY is packaged with Model V780-HMD68-ETN-EU.

Regulations

Model	Regulations
V780-HMD68-ETN-US	FCC 15.247 (United states) ISED RSS-247 (Canada)
V780-HMD68-ETN-MX	IFT-008 NYCE NOM-208

V780-HMD68-ETN-US

Tag Communication Specifications

Item	V780-HMD68-ETN-US
Applicable countries	United States and Canada
Maximum Radiated Power	4 W e.i.r.p
Output power	15 to 27 dBm (Switchable in 1-dB increments.)
RSSI detection range	Signal level: -35 to -61 dBm Noise level: -35 to -70 dBm (at end of antenna cable)
Transmission speed from Reader/Writer to RF Tag	40 kbps (fixed)
Transmission speed from RF Tag to Reader/Writer	<ul style="list-style-type: none"> • 80 kbps (High-speed Mode) * • 31.25 kbps (Standard Mode) *
Used frequencies	50 channels (902.75 to 927.25 MHz) FHSS
Channel interval	500 kHz
Communications method with RF Tags	Miller-modulated subcarrier
Tag communications protocol	ISO/IEC 18000-63: 2013 (EPCglobal Class-1 Generation-2)
Polarization characteristic	RHCP
Multiaccess communications	Up to 64 RF Tags can be read.

* The default setting is for Automatic Mode. The Reader/Writer will automatically change to High-speed Mode or Standard Mode depending on the interference waves.

V780-HMD68-ETN-MX

Item	V780-HMD68-ETN-MX
Applicable countries	Mexico
Maximum Radiated Power	4 W e.i.r.p
Output power	15 to 27 dBm (Switchable in 1-dB increments.)
RSSI detection range	Signal level: -35 to -61 dBm Noise level: -35 to -70 dBm (at end of antenna cable)
Transmission speed from Reader/Writer to RF Tag	40 kbps (fixed)
Transmission speed from RF Tag to Reader/Writer	<ul style="list-style-type: none"> • 80 kbps (High-speed Mode) * • 31.25 kbps (Standard Mode) *
Used frequencies	50 channels (902.75 to 927.25 MHz) FHSS
Channel interval	500 kHz
Communications method with RF Tags	Miller-modulated subcarrier
Tag communications protocol	ISO/IEC 18000-63: 2013 (EPCglobal Class-1 Generation-2)
Polarization characteristic	RHCP
Multiaccess communications	Up to 64 RF Tags can be read.

* The default setting is for Automatic Mode. The Reader/Writer will automatically change to High-speed Mode or Standard Mode depending on the interference waves.

Recommended Power Supply (24 VDC)

Item	Condition
Supply voltage	24 VDC -15% to +10%
Output current	500 mA min.
Safety standard	SELV (Safety Extra Low Voltage)

V780 Series

RF Tag (Recommended)

Item	Model	V780-A-JIME-Z3BLI-10 (made by Toppan Forms Co., Ltd.)
Dimensions		150 × 14 × 6 mm (W × H × D)
IC chip, memory		Monza X 8K UII(EPC): 128 bits User memory: 8,192 bits (1 Kword)
Data retention		10 years
Write life		10,000 writes
Operating temperature		-20 to 65°C
Operating humidity		5% to 95%
Storage temperature		-30 to 70°C
Storage humidity		5% to 95%
Material		Polycarbonate plastic
Weight		Tag: Approx. 15 g
Degree of protection		IP68 (IEC 60529: 2001)

RF Tag Attachment (Recommended)

Item	Model	V780-A-TA-133 (made by Toppan Forms Co., Ltd.)
Dimensions		180 × 50 × 30 mm (W × H × D)
Operating temperature		-20 to 65°C
Operating humidity		5% to 95%
Storage temperature		-30 to 70°C
Storage humidity		5% to 95%
Material		Polycarbonate plastic
Weight		Approx. 128 g

Characteristic Data V780-HMD68-ETN-US (for Reference Only)

Communications range

The communications range differs depending on the radio regulations of each country. Moreover, the communications range may change under the influence of the ambient environment, type of RF Tags, and the items on which RF Tags are mounted. Sufficiently verify the communications range in advance.

RF Tag : V780-A-JIME-Z3BLI-10 (Toppan Forms Co., Ltd.)
(Back Surface: Metal, with Attachment, V780-A-TA-133-10)

Transmission power: 27dBm

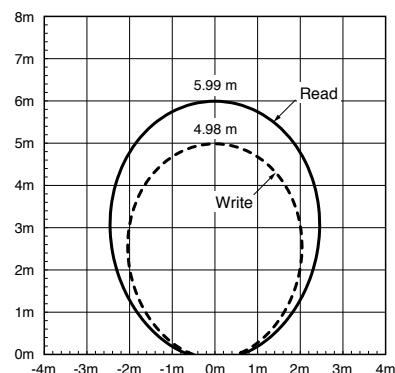

RF Tag Communication Times

The communications time differs depending on the radio regulations of each country, or the settings of the RF communications command and RF communications speed. In actual usage, the communications time may change under the influence of the installation environment, system conditions, type of RF Tags, and other factors. Perform sufficient testing in advance.

RF Tag : V780-A-JIME-Z3BLI-10 (Toppan Forms Co., Ltd.)

ID READ (Single-access)

During 6-word (96bit) data readout from the UII (EPC) area

RF communications speed	Communications time
High speed	21 ms
Normal speed	27 ms

DATA READ (Single-access)

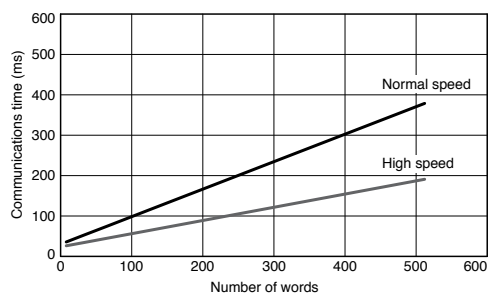

DATA WRITE (Single-access)

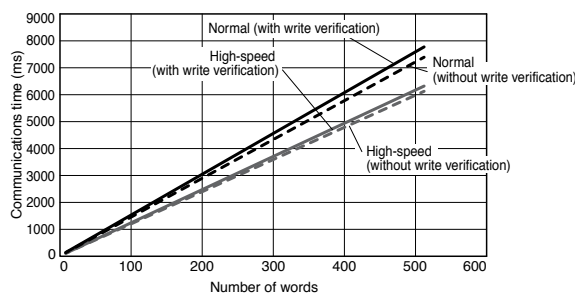

Note: Refer to the V780 Series User's Manual for details.

ID READ (Multi-access)

During 6-word (96bit) data readout from the UII (EPC) area

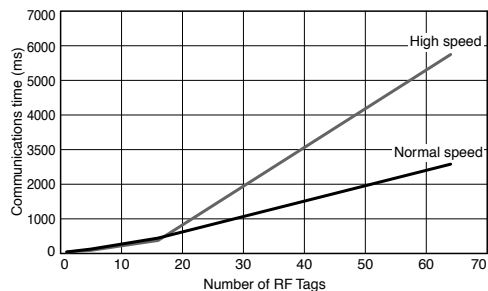

DATA READ (Multi-access)

Reading 32 Words of Data from the User Area

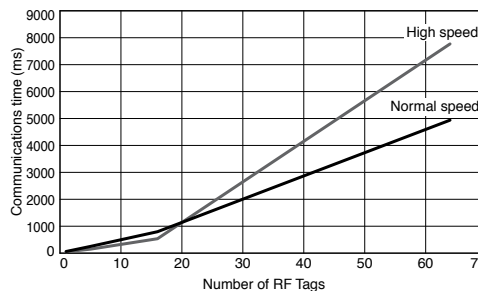

- Note: 1.** If you set the RF communications speed to high speed, there will generally be a higher rate of collisions in communications with RF Tags than for the normal speed. Therefore, if there are too many RF Tags, the high speed may actually result in longer communications times.
- 2.** Refer to the V780 Series User's Manual for details.

V780 Series

Characteristic Data V780-HMD68-ETN-MX (for Reference Only)

Communications range

The communications range differs depending on the radio regulations of each country. Moreover, the communications range may change under the influence of the ambient environment, type of RF Tags, and the items on which RF Tags are mounted. Sufficiently verify the communications range in advance.

RF Tag : V780-A-JIME-Z3BLI-10 (Toppan Forms Co., Ltd.)
(Back Surface: Metal, with Attachment, V780-A-TA-133-10)

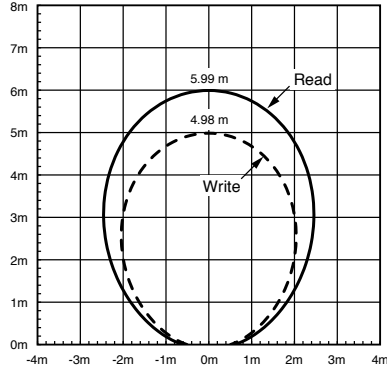

RF Tag Communication Time

The communications time differs depending on the radio regulations of each country, or the settings of the RF communications command and RF communications speed. In actual usage, the communications time may change under the influence of the installation environment, system conditions, type of RF Tags, and other factors. Perform sufficient testing in advance.

RF Tag : V780-A-JIME-Z3BLI-10 (Toppan Forms Co., Ltd.)

ID READ (Single-access)

During 6-word (96bit) data readout from the Ull (EPC) area

RF communications speed	Communications time
High speed	21 ms
Normal speed	27 ms

DATA READ (Single-access)

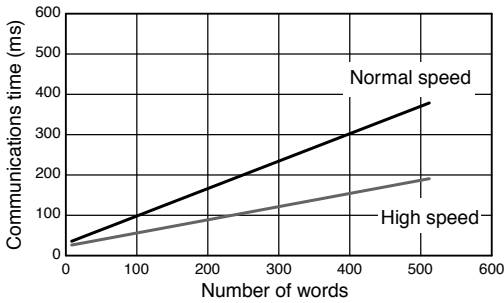

DATA WRITE (Single-access)

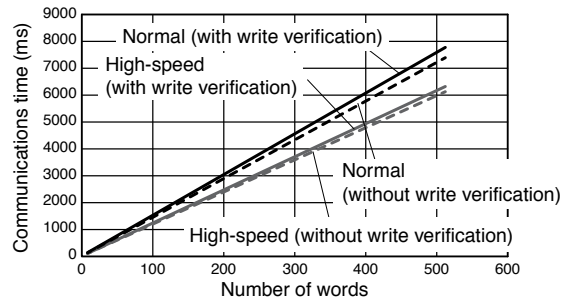

ID READ (Multi-access)

During 6-word (96bit) data readout from the Ull (EPC) area

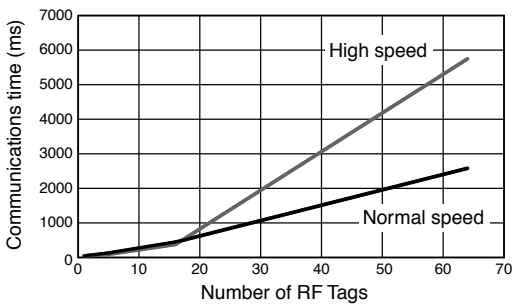

DATA READ (Multi-access)

Reading 32 Words of Data from the User Area

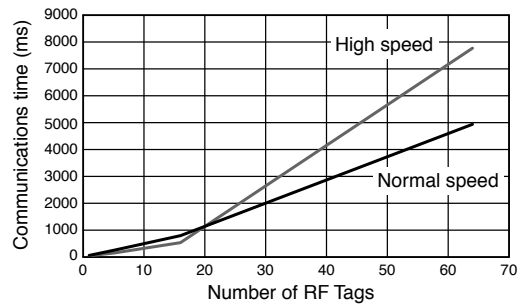

Dimensions

(Unit: mm)
Tolerance class IT16 applies to dimensions in this datasheet unless otherwise specified.

Reader/Writer

V780-HMD68-ETN-@@

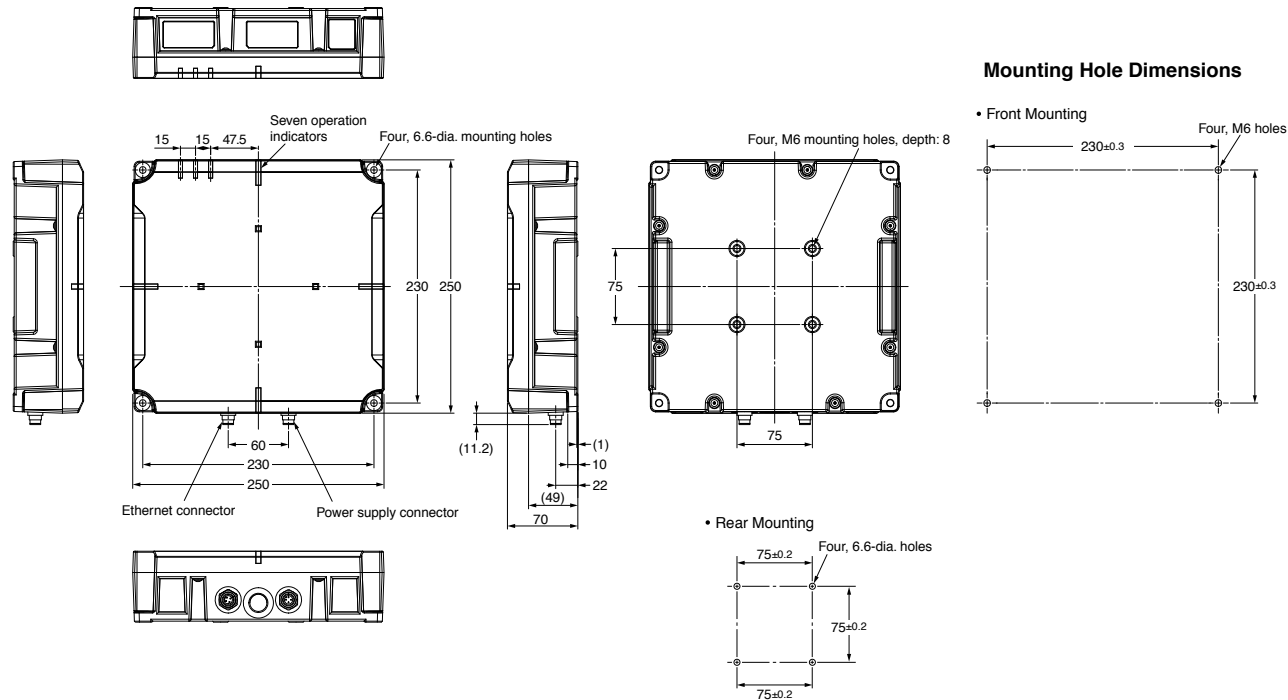

RF Tag

V780-A-JIME-Z3BLI-10 (Toppan Forms Co., Ltd. Model Number: JIME-Z3BLI)

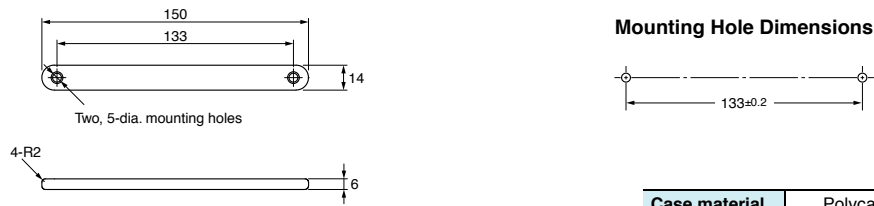

RF Tag Attachment

V780-A-TA-133-10 (Toppan Forms Co., Ltd. Model Number: TA-133)

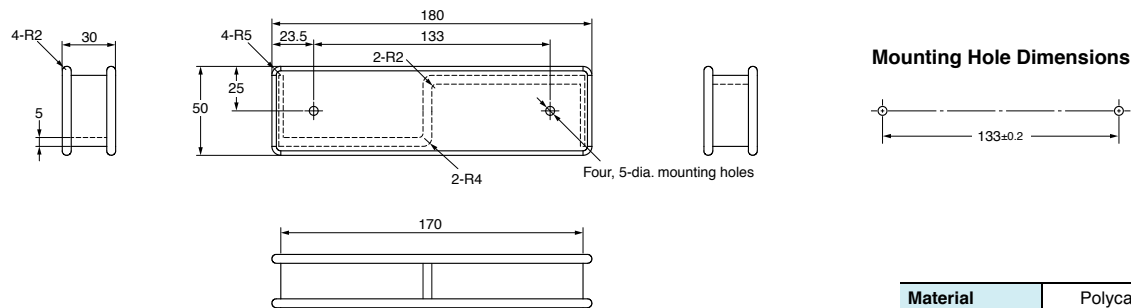

Related Manuals

Cat. No.	Name
Z389-E1	UHF RFID System V780-series Reader/Writer User's Manual

OMRON AUTOMATION AMERICAS HEADQUARTERS • Chicago, IL USA • 847.843.7900 • 800.556.6766 • www.omron247.com

OMRON CANADA, INC. • HEAD OFFICE

Toronto, ON, Canada • 416.286.6465 • 866.986.6766 • www.omron247.com

OMRON ELECTRONICS DE MEXICO • HEAD OFFICE

México DF • 52.55.59.01.43.00 • 01.800.226.6766 • mela@omron.com

OMRON ELECTRONICS DE MEXICO • SALES OFFICE

Apodaca, N.L. • 52.81.11.56.99.20 • 01.800.226.6766 • mela@omron.com

OMRON ELETRÔNICA DO BRASIL LTDA • HEAD OFFICE

São Paulo, SP, Brasil • 55.11.2101.6300 • www.omron.com.br

OMRON ARGENTINA • SALES OFFICE

Cono Sur • 54.11.4783.5300

OMRON CHILE • SALES OFFICE

Santiago • 56.9.9917.3920

OTHER OMRON LATIN AMERICA SALES

54.11.4783.5300

Authorized Distributor:

Controllers & I/O

- Machine Automation Controllers (MAC) • Motion Controllers
- Programmable Logic Controllers (PLC) • Temperature Controllers • Remote I/O

Robotics

- Industrial Robots • Mobile Robots

Operator Interfaces

- Human Machine Interface (HMI)

Motion & Drives

- Machine Automation Controllers (MAC) • Motion Controllers • Servo Systems
- Frequency Inverters

Vision, Measurement & Identification

- Vision Sensors & Systems • Measurement Sensors • Auto Identification Systems

Sensing

- Photoelectric Sensors • Fiber-Optic Sensors • Proximity Sensors
- Rotary Encoders • Ultrasonic Sensors

Safety

- Safety Light Curtains • Safety Laser Scanners • Programmable Safety Systems
- Safety Mats and Edges • Safety Door Switches • Emergency Stop Devices
- Safety Switches & Operator Controls • Safety Monitoring/Force-guided Relays

Control Components

- Power Supplies • Timers • Counters • Programmable Relays
- Digital Panel Meters • Monitoring Products

Switches & Relays

- Limit Switches • Pushbutton Switches • Electromechanical Relays
- Solid State Relays

Software

- Programming & Configuration • Runtime