

# Bringing Technology to Life

Machine Interface NA Series



- Fully integrated machine control system
- Powerful Sysmac Studio software
- Customizable functions

# Integrated HMI within the Sysmac Platform

An HMI that is dynamic, intuitive and predictive makes industrial machines more attractive and competitive. The Omron Sysmac NA Series HMI enables faster, more efficient control and monitoring - and a more natural, proactive relationship between operator and machine. The design has been based on real applications and customer requirements, a future-proofed, scalable platform that will evolve with their ever-changing needs, allowing real time reaction to events. As part of the system family, the NA Series is fully aware of the total machine.

- Proactive operator/ machine relationship
- Design based on real applications and customer requirements
- Future-proof, scalable platform
- Allows quick reaction





G5 servo system



FH Vision System



NX I/O  
NX Safety



NJ/NX Machine Automation Controller



# Integrating your world

Sysmac Studio is the centerpiece of the Sysmac Platform, bringing together all areas of automation including: logic, motion, vision, safety and now visualization. The NA series machine interface brings you a clear view in one integrated project.

## ONE Tag Database

- Share NJ/NX Variables (Tags) in the machine interface application. “Intelli sense” makes it FAST
- Flexible programming with variables including union and enumeration variables
- Define/use NA data structures in the machine interface application



### ONE Learning, ONE Project

- Program your controller and safety systems
- Simultaneously program the NA Series as device in Sysmac Studio
- Program your whole machine in one project
- Work in a familiar way on all devices

### Safe and secure

- Configure individual users with multi access levels

### SIMPLE

- Clearly and quickly define the View
- Quickly change properties, animations, events and actions
- Powerful page editor to group objects
- Rotate, and resize - all with a simple click

### BUT STILL FLEXIBLE

- Write your Visual Basic Script
- Extend the possibilities with Visual Basic

### Test it in ONE

- Integrated testing through simulation of motion, logic and visualization at the same time
- Build confidence before having a single piece of hardware
- Test your machine interface with the NJ/NX Control program via the Simulator in Sysmac Studio

### Features for speed

- Structured programming (through One software)
- Network device insight
- Vision setup
- Machine Controller troubleshooting



# Insight & security maximized ...

The NA series has full security and authentication features that keep your valuable assets secure at all times. And if something unexpected does happen, in your machine you will be able to solve the problem quickly and prevent a reoccurrence.

## Remote access

- You can view and operate the HMI installed at production sites from your tablet using Ethernet or WiFi.
- The access of remote devices can be managed and limited. This helps prevent accidental operation and information leakage, while securing accessibility.

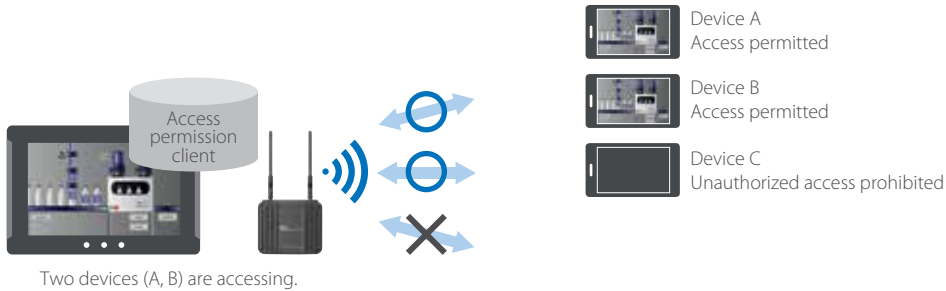

## Increased security

The NA Series can be configured to specific staff, with multi access levels with password protection. This ensures authorized people interact with the machine.



## Protecting your assets

- Your project can be password-protected along with other applications (Control and Safety).
- Transferring data can be protected (disable overwrite or theft).



# ... downtime minimized

You can present a machine view that is understandable at a glance. The NA Series brings everything together through rich media including PDF, video, and data to provide an intuitive and proactive machine management tool.



### Show your manual in a movie

Imagine actually showing how to perform certain procedures. With the NA Series you have a trained engineer at the operator's side, 24x7.



### Show PDFs

You can use whatever visual assets you already have to illustrate how to do things.

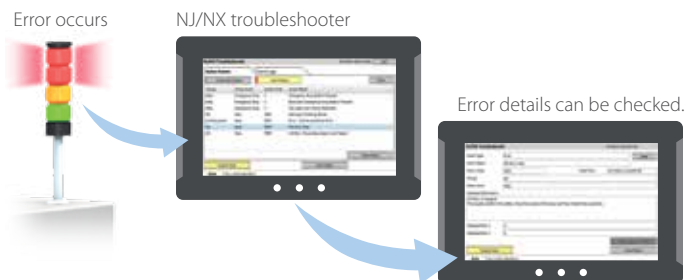

### Check the controller

The troubleshooter allows you to monitor and release the NJ/NX Controller errors/events as well as the user-defined errors/events.

# Simple, but Flexible!

The NA Series gives the user the ability to design using IAGs (Intelligent Application Gadgets). IAGs simplify and accelerate the development process through structuring the project and enhancing reuse. From simple graphics to complex objects, you can make your own collections and share them between projects, like a Function Block.

## Step 1: Machine Parts, the Visual

Using standard controls, or graphics from the machine parts collection, design your own IAG. Add interface properties and methods to bring the object to life when reused.

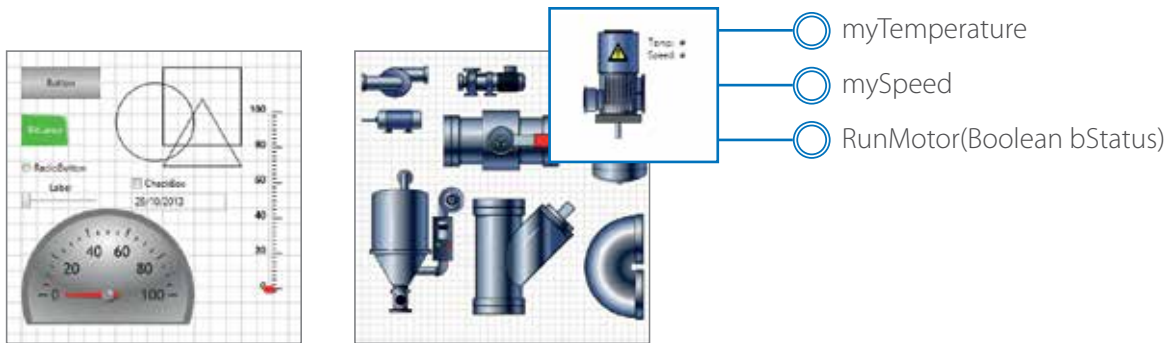

1

```
'IAG Code behind - Add local subroutines for the IAG.
Public Function RunMotor(bStatus As Boolean) As Double
    'start motor at default speed
    mySpeed = 50
    'return current speed
    RunMotor = 50
End Function

Public Function IncreaseSpeed(nIncrement As Integer) As Double
    'Increase speed by increment if < 1000
    If mySpeed + nIncrement < 1000 Then
        mySpeed = mySpeed + nIncrement
    Else
        'otherwise set to top speed
        mySpeed = 1000
    End If
    'Return new speed
    IncreaseSpeed = mySpeed
End Function
```

## Step 2: Extensible with Visual Basic

As well as many graphic IAGs, it is also possible to embed code within an IAG. The code can extend the possibilities of the gadget such as providing special device communication. Thanks to Visual Basic the standard functionality of the NA can be extended as required.

2





### Step 3: Publish and Share

When the IAG is built and tested (using simulation) it can be published and the collection file distributed to be used again and again. Omron will release further IAG collections to extend the functionality of the NA Series.

3

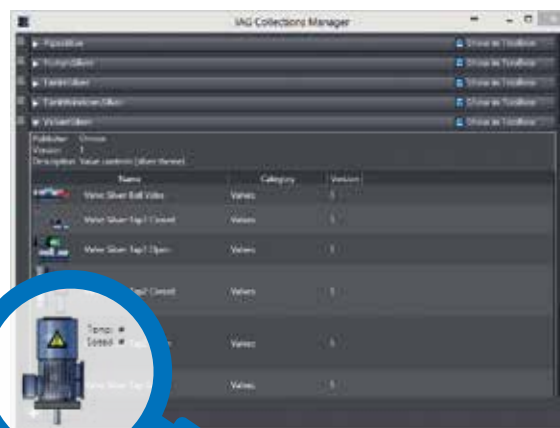

# A range of options that covers every need

All wide screen models: 7, 9, 12, 15 inch

Black and Silver

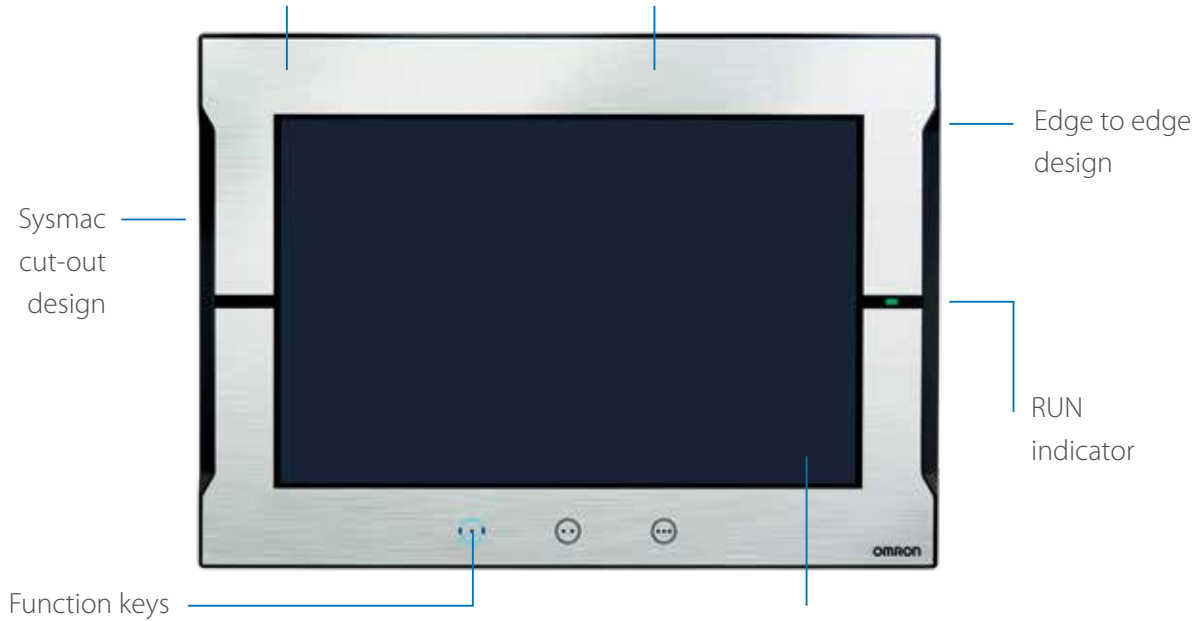

Resistive touch screen, single touch ...ideal for environments where operators wear gloves and water proof is needed



1 USB slave (Tool port)

2 2x USB

3 1 Serial\*

4 2 Ethernet ports, one for factory one for office network

5 SD Card slot

6 24V DC

\* The serial port is for future expansion.



- High speed communications network
- Broad choice of connection possibilities
- USB cable detachable without changing the hardware
- Water and dust proof design

# Graphic Interface Tools to Optimize the user Experience

## Vector graphics

DXF files are supported to display CAD data. Even if the drawing is enlarged or reduced in size, it never loses quality. Supported format: DXF

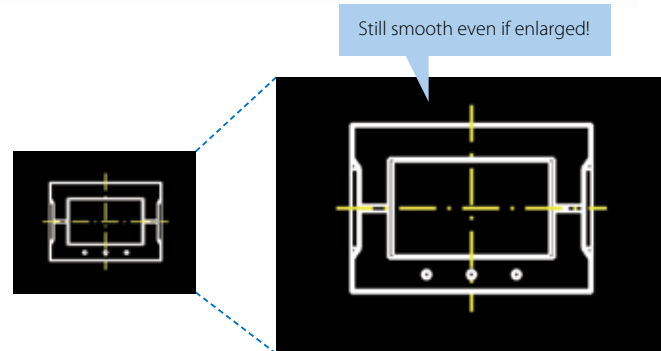

## Indirect reference of text strings

A text string that is displayed on a label object (1 line) or a text box object (1 or more lines) can be switched by indirect reference. The machine operating status and alarm details can be easily displayed.

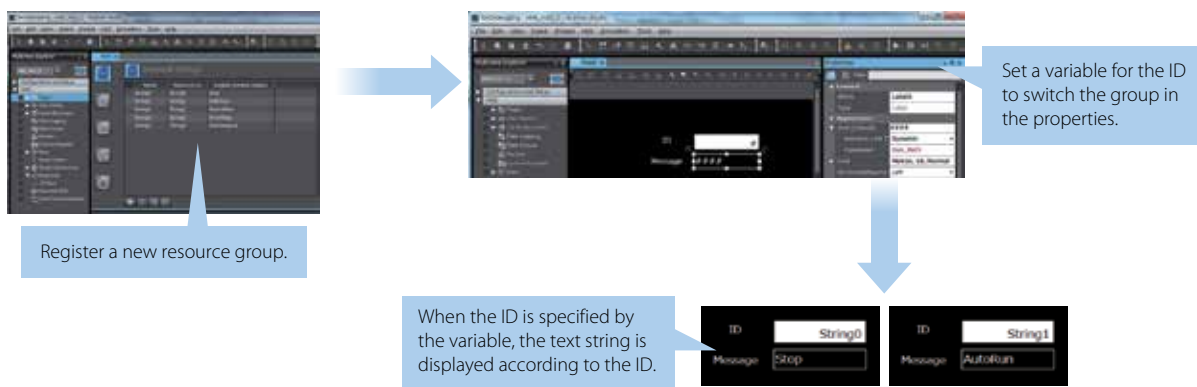

## Tab control

A part of the screen can be used like a notepad.

Up to 64 tab pages for a Tab Control object can be created, and up to 10 Tab Control objects can be placed on a screen.

Change a tab page instead of a screen to monitor/change various data.

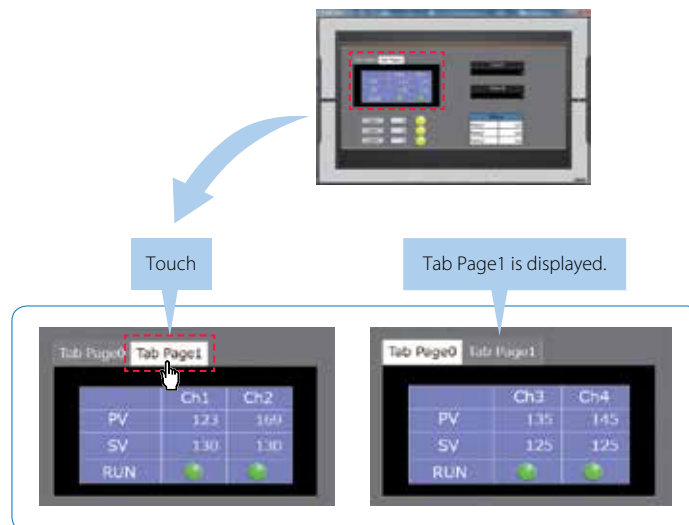

### Broken-line graphs

Data of variables and multidimensional arrays in the controller can be displayed as broken-line graphs. Broken-line graphs can also be created from the data in the CSV files saved in the SD card inserted in the NJ Controller by using subroutines (Visual Basic). You can specify the display range of large array data, such as operation log, by setting the offset value. This increases the compatibility with the controller.

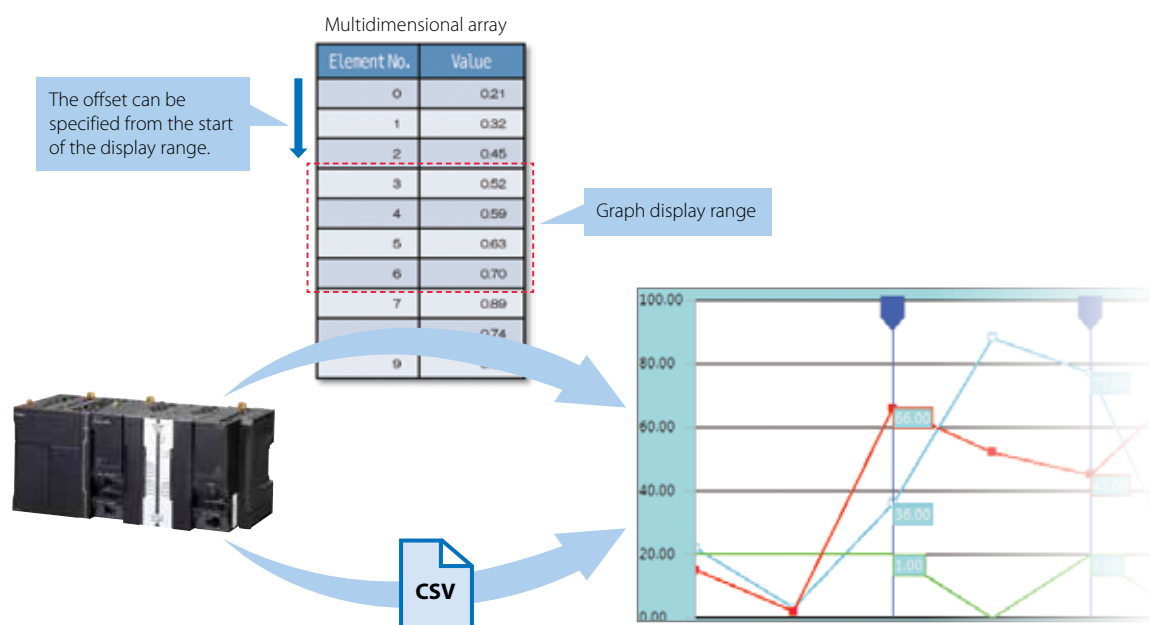

### Scaling

Scaling can be set for Data Display/Data Edit objects and global variables.

Values of variables can be converted by specifying conversion expressions, which makes it easy to show data in the controller.

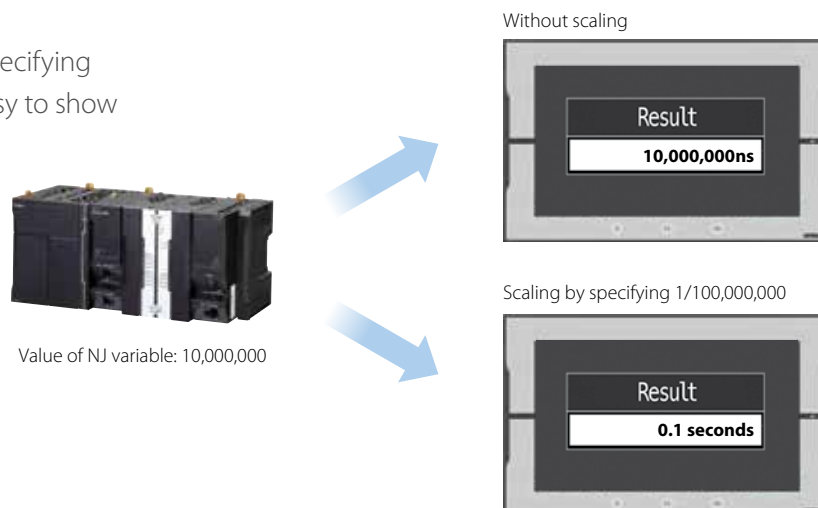

### Supporting Asian languages

An Asian language - Japanese, simplified Chinese, traditional Chinese, or Korean - can be selected to use in the keypad of the NA Series.

The keypad language changes automatically when the language is changed in the language settings.

Local languages can be used to input the names of products when new recipes of the food packaging machine are added.

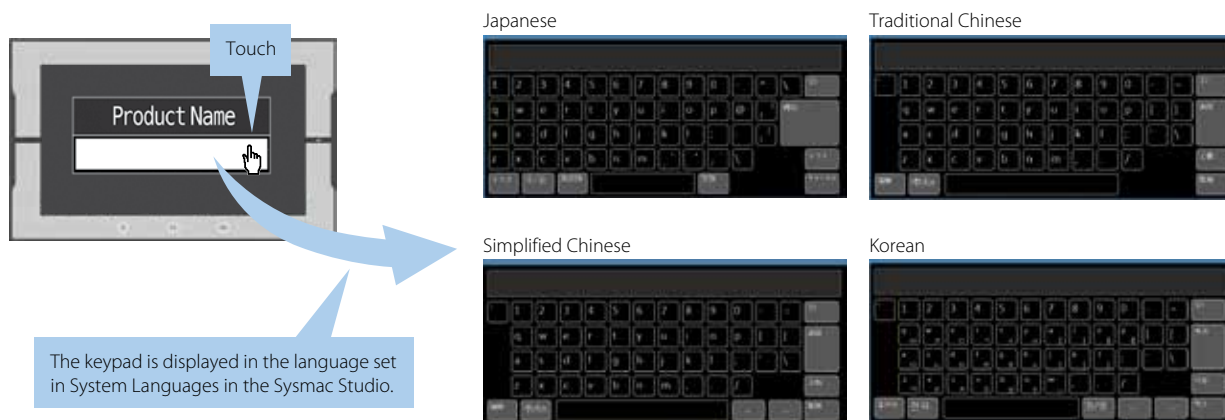

### Executing a subroutine with multiple threads

Some subroutines require time due to repeated processing or waiting time.

Even such a subroutine can be executed during screen update, without affecting operability and visibility.

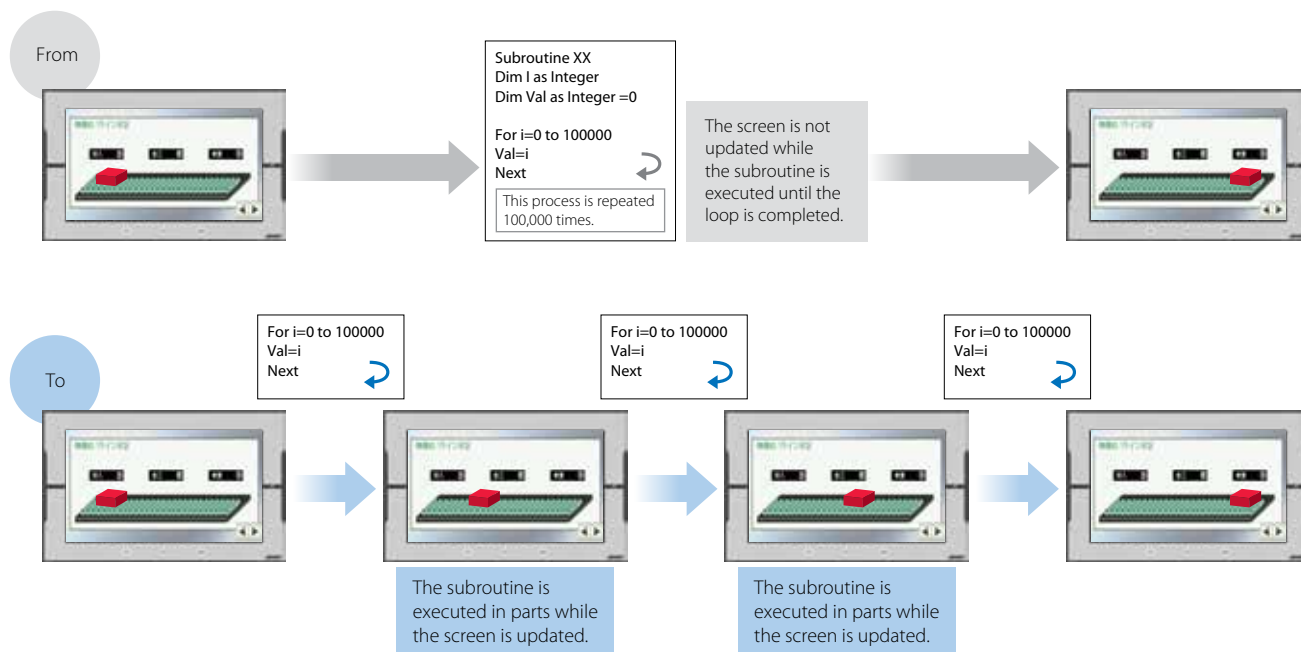

### Custom keypads

You can change the keypad size, choose only the keys you need, and customize the keys to execute specified actions. Create your own keypad suitable for your applications.

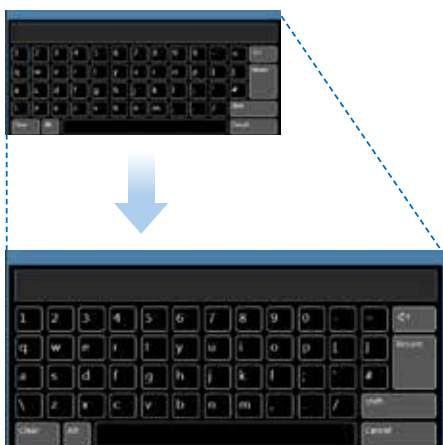

**Changing the keypad size**  
The size can be changed to suit the user's needs.

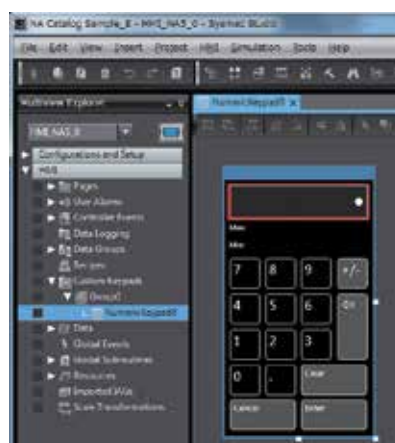

**Creating user's own keypad**  
Only the keys the user needs can be chosen, and the keys to execute specified actions can be customized.

### Page jump from user alarm

The page to switch can be specified in each alarm setting.

When an alarm occurs, you can check the troubleshooter screen by selecting the displayed alarm.

Name	Alarm ID	Alarm Code	Expression	Priority	Message	Popup	Acknowledge	Page
A1	Group0_A1	Alarm1	Alarm1=True	User Fault Level 1	Alarm1	<input type="checkbox"/>	<input type="checkbox"/>	Page5
A2	Group0_A2	Alarm2	Alarm2=True	User Fault Level 1	Alarm2	<input type="checkbox"/>	<input type="checkbox"/>	Page3
A3	Group0_A3	Alarm3	Alarm3=True	User Fault Level 1	Alarm3	<input type="checkbox"/>	<input type="checkbox"/>	Page4
A4	Group0_A4	Alarm4	Alarm4=True	User Fault Level 1	Alarm4	<input type="checkbox"/>	<input type="checkbox"/>	Page3
A5	Group0_A5	Alarm5	Alarm5=True	User Fault Level 1	Alarm5	<input type="checkbox"/>	<input type="checkbox"/>	Page2

The page to switch can be specified in each alarm setting.

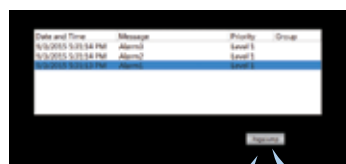

Select the alarm and then click the Page Jump Button.

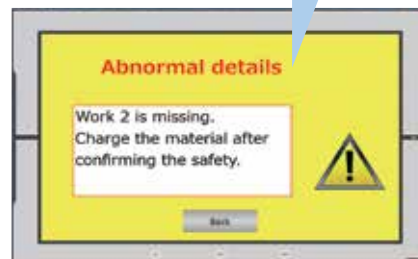

The specified page is displayed.

### Importing external device variables

External device variables can be imported from an XLSX or CXT file. The CJ variable files and Excel files containing edited variables can be imported. Imported variables facilitate programming including external device settings.

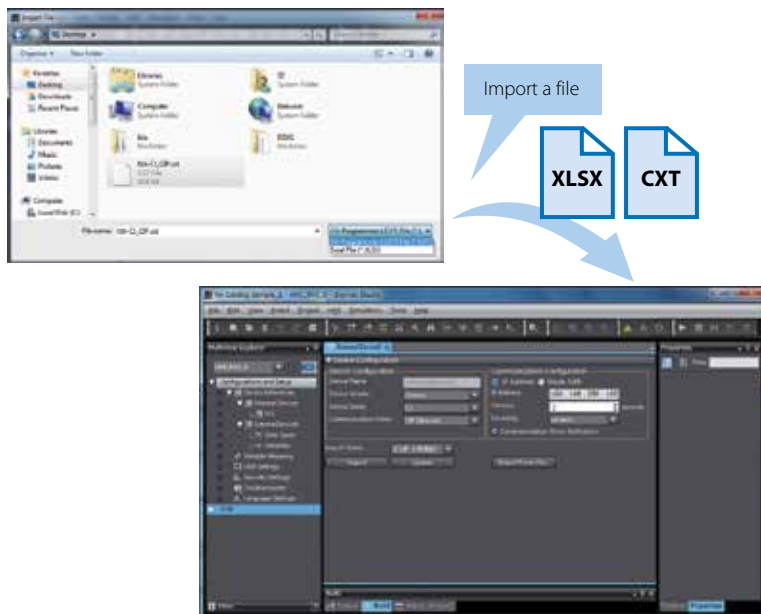

### Cross references

The same GUI cross reference function as the NJ/NX Controller can be used. When the variable to search is clicked in the global variable table, a list of the locations where the variable is used is displayed in the Cross Reference Tab Page. You can access the object or subroutine where the variable is used by clicking the location, which makes screen design and debugging quicker and easier.

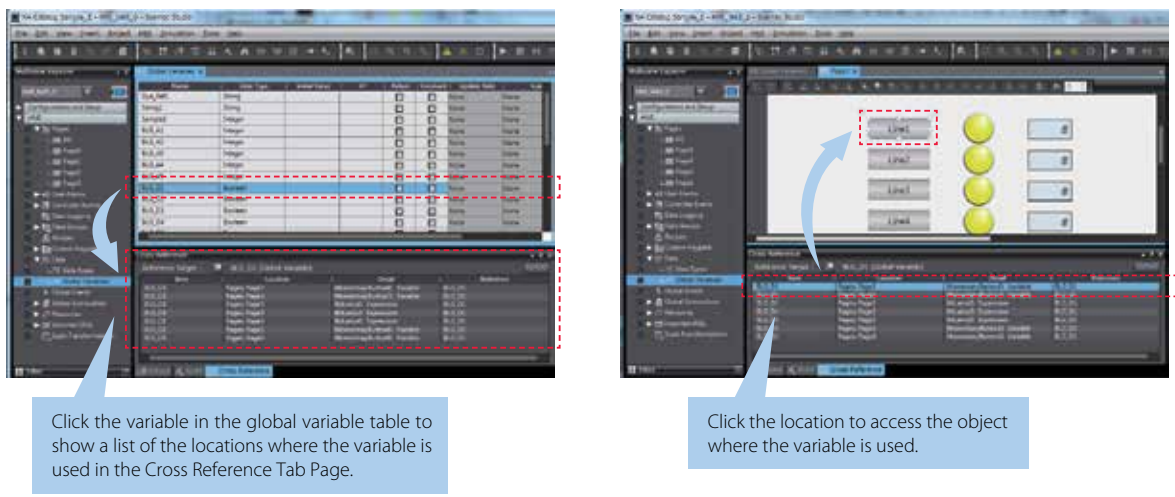

Click the variable in the global variable table to show a list of the locations where the variable is used in the Cross Reference Tab Page.

Click the location to access the object where the variable is used.



### Search and Replace

You can search and replace text strings in all subroutines (Visual Basic), objects, and variables within a project.

It is quick and easy to edit and debug variable names and switch labels.

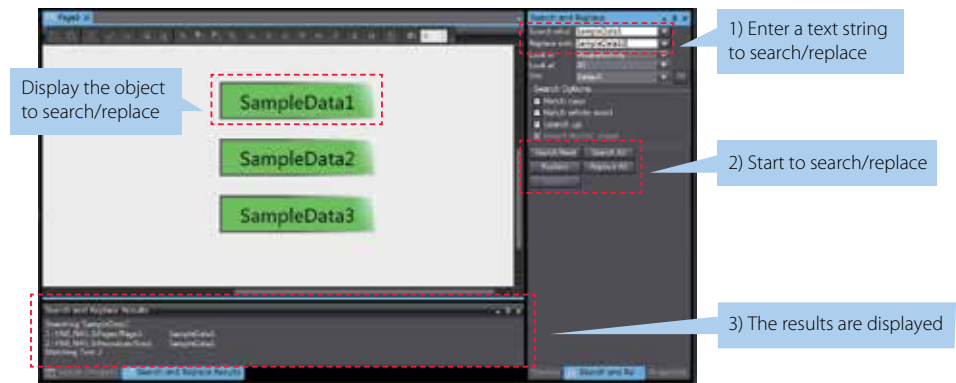

### Text editing

You can edit a label either directly on the Page Editor or in its properties. Editing in the object properties is recommended to edit the ON and OFF labels and change the font attributes at the same time.

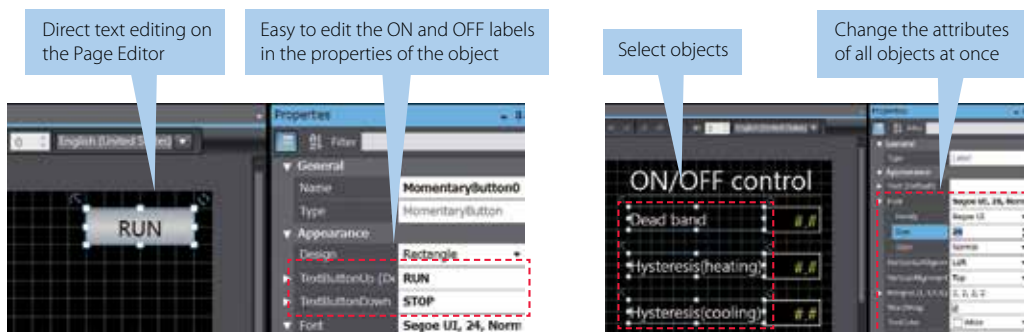

In the properties, the font attributes (font type, size, and color) of multiple labels can be changed at the same time.

### Data input order

The Data input order can be set. When numeric values are entered consecutively, the focus automatically moves to the next Data Edit object by touching the Enter key.

Input errors and input time can be minimized.

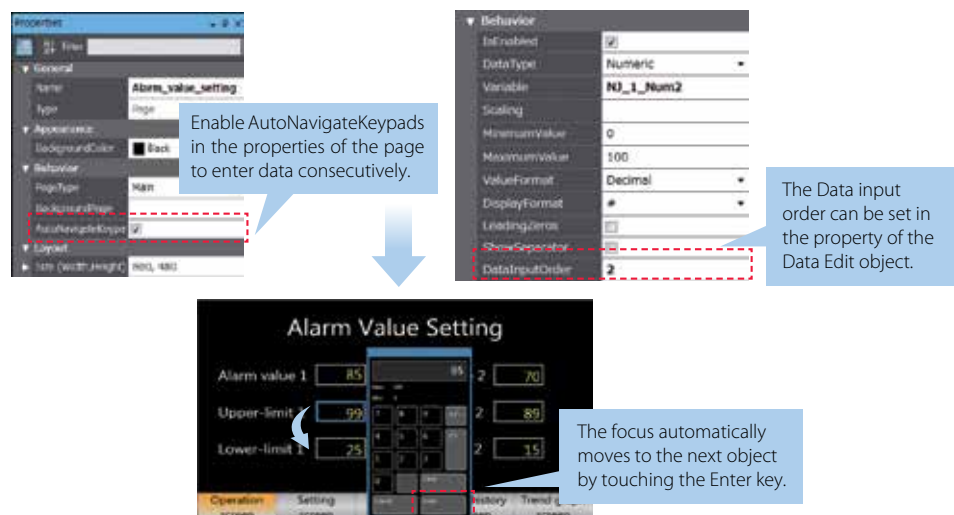

### Watch Tab Page

The same GUI as the NJ/NX Controller is used. Register the variable to monitor/change and then change its value on the Watch Tab Page to easily debug screens with the NA Simulator without the physical HMI. (Broken-line Graph and Trend Graph objects cannot be used for simulations.)

Name	Online value	Modify	Comment	Data type	AT	Display format
NJ_1_ALM1	True	TRUE FALSE		Boolean	NJ_1_ALM1	Boolean
NJ_1_ALM2	False	TRUE FALSE		Boolean	NJ_1_ALM2	Boolean
NJ_1_Lamp	True	TRUE FALSE		Boolean	NJ_1_Lamp	Boolean
NJ_1_Start	False	TRUE FALSE		Boolean	NJ_1_Start	Boolean
NJ_1_Num1	123	123		Short	NJ_1_Num1	Decimal

Change to TRUE

Check the alarm with the Simulator



### Displaying object status

The ON/OFF status of the object placed on the Page Editor can be switched. You can check the ON/OFF status of a Lamp or other object without starting the Simulator. Not only the ON/OFF status of a Bit Lamp object but also all status of a Data Lamp object can be checked.

Switch between ON and OFF.

Change the status of the Data Lamp object.



### NA screen capture

The screens displayed on the NA Series can be captured and saved in the SD card inserted in the NA Series or the USB memory connected to the NA Series.

- When a screen of the NA Series is required to create a machine operation manual
- When the current screen is required to save as proof of a trouble

Supported format: PNG

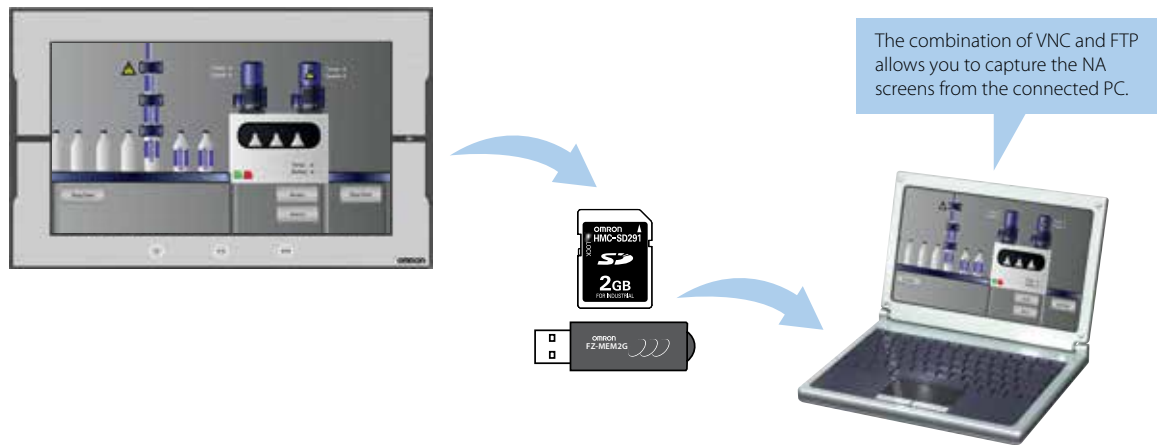

### Sysmac Studio printing

Project information including screens and properties can be printed from the Sysmac Studio. This function is useful when you create machine manuals.

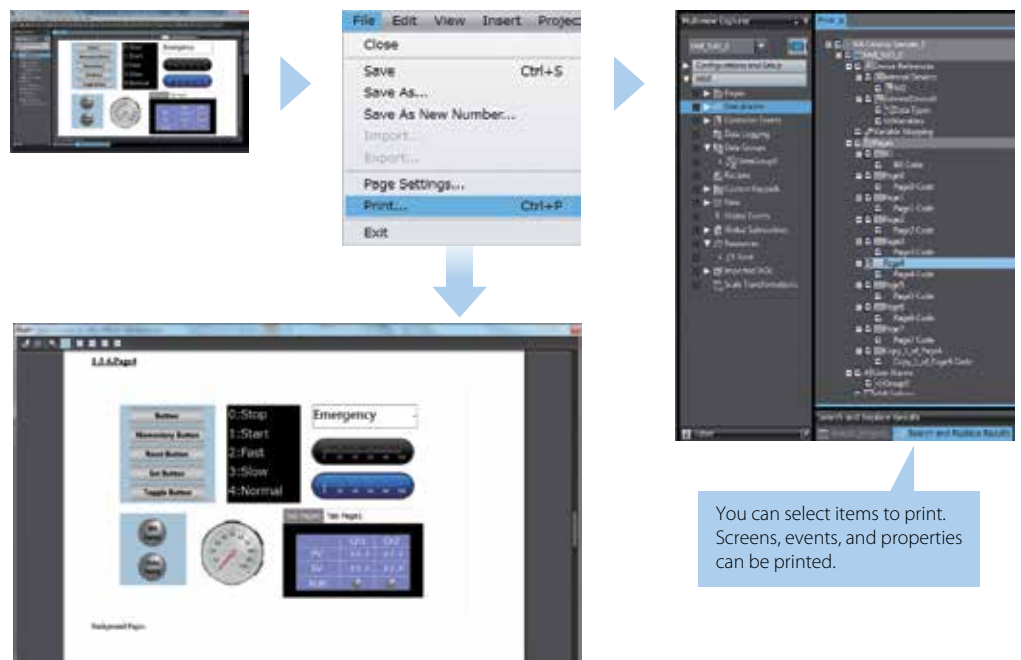

# Programmable Terminal NA series

## Bringing technology to life

The NA-series Programmable Terminal allows vibrant visualization of machine data in industrial applications, enhancing usability with multi-media.

The NA Series, together with the NJ Series Machine Automation Controller and the Automation Software Sysmac Studio, allows you to simply and flexibly create sophisticated user interfaces to suit your machines.

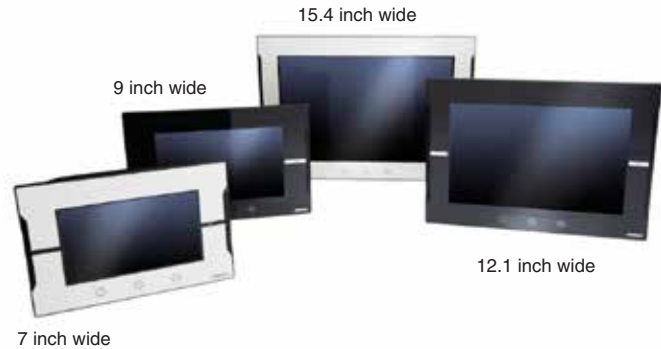

## Features

---

- Widescreen in all models: 7, 9, 12, and 15 inches
- More than 16 million color display for all models and 1280 x 800 high resolution display for the 12 and 15-inch models
- Multimedia including video and PDF
- 2 Ethernet ports capable of simultaneous access from both the control device and maintenance segments by separating the segments
- Sysmac Studio providing an Integrated Development Environment
- NJ Global Variables are exposed to the NA without CIP publishing. Test the complete system via the integrated Simulator
- Many security features including operation authority settings and execution restrictions with IDs
- Microsoft Visual Basic for versatile, flexible and advanced programming

Sysmac is a trademark or registered trademark of OMRON Corporation in Japan and other countries for OMRON factory automation products. Windows, Visual Basic, Word, Excel are either registered trademarks or trademarks of Microsoft Corporation in the United States and/or other countries. EtherCAT® is a registered trademark and patented technology, licensed by Beckhoff Automation GmbH, Germany. EtherNet/IP™s the trademarks of ODVA. Other company names in this document are the trademarks or registered trademarks of their respective companies. The product photographs and figures that are used in this catalog may vary somewhat from the actual products. Microsoft product screen shot(s) reprinted with permission from Microsoft Corporation.

## System configuration

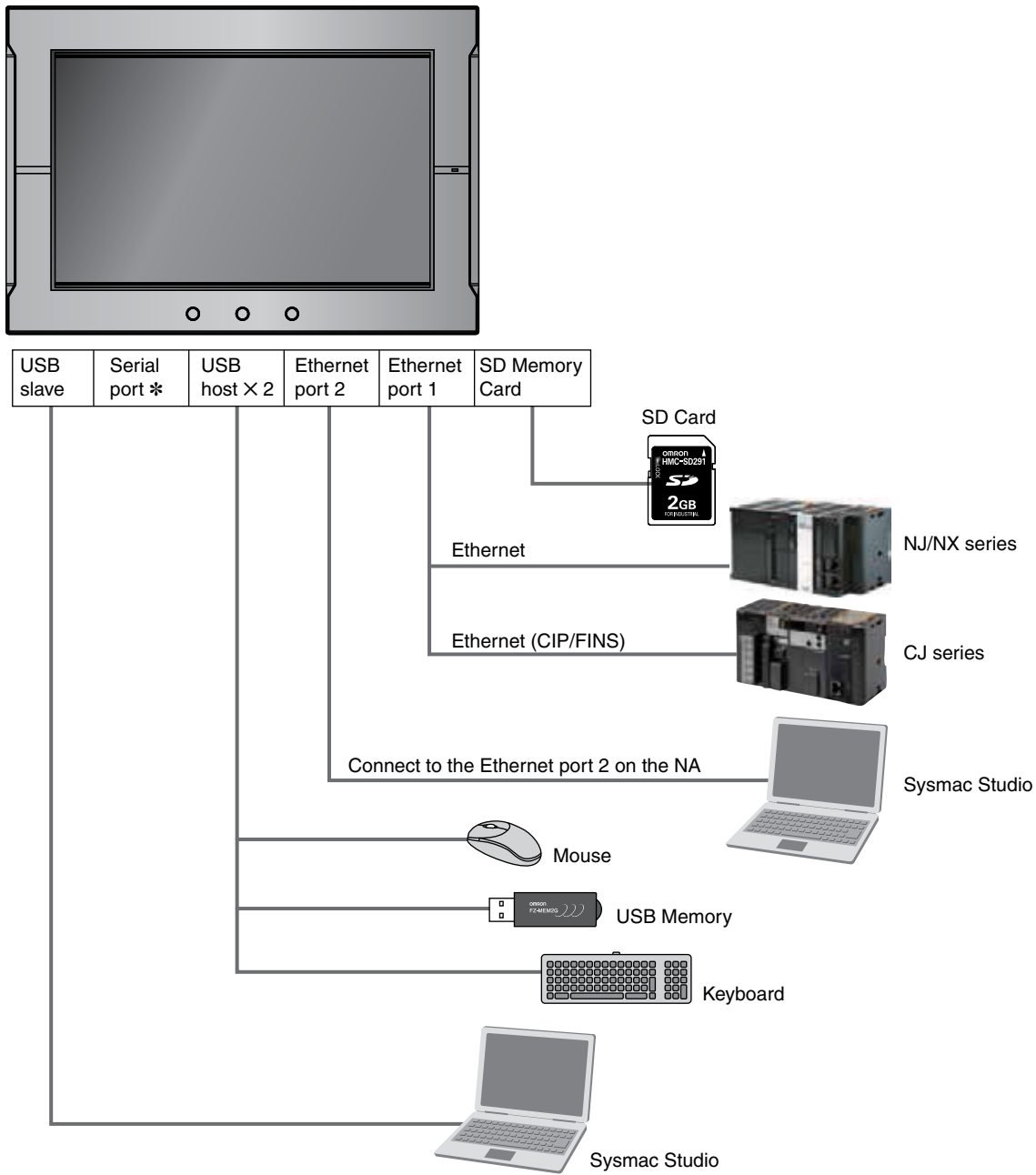

\* The serial port is for future expansion.

## NA Series

### Ordering Information

#### NA5-□W

Product name	Specifications	Model
NA5-15W	15.4 inch wide screen, TFT LCD, 16,770,000 colors (24 bit full color), 1280 × 800 dots, Frame color : Silver	NA5-15W101S
	15.4 inch wide screen, TFT LCD, 16,770,000 colors (24 bit full color), 1280 × 800 dots, Frame color : Black	NA5-15W101B
NA5-12W	12.1 inch wide screen, TFT LCD, 16,770,000 colors (24 bit full color), 1280 × 800 dots, Frame color : Silver	NA5-12W101S
	12.1 inch wide screen, TFT LCD, 16,770,000 colors (24 bit full color), 1280 × 800 dots, Frame color : Black	NA5-12W101B
NA5-9W	9 inch wide screen, TFT LCD, 16,770,000 colors (24 bit full color), 800 × 480 dots, Frame color : Silver	NA5-9W001S
	9 inch wide screen, TFT LCD, 16,770,000 colors (24 bit full color), 800 × 480 dots, Frame color : Black	NA5-9W001B
NA5-7W	7 inch wide screen, TFT LCD, 16,770,000 colors (24 bit full color), 800 × 480 dots, Frame color : Silver	NA5-7W001S
	7 inch wide screen, TFT LCD, 16,770,000 colors (24 bit full color), 800 × 480 dots, Frame color : Black	NA5-7W001B
High-pressure Waterproof Attachment for NA5-□W	This metal frame is for high-pressure waterproofing. Install it to conform to UL Type 4X standards. UL Type 4X is the rating for high-pressure wash-down applications with a flow rate of 246 liter/min. This attachment can be used for the NA5-□W, but not for the NA5-□U.	NA-15WATW01
		NA-12WATW01
		NA-9WATW01
		NA-7WATW01

Note: The NA5-□U is also available. Contact your OMRON representative for details.

#### Options

Product name	Specifications	Model
SD memory card	2 GB	HMC-SD291
	4 GB	HMC-SD491
USB Memory	2 GB	FZ-MEM2G
	8 GB	FZ-MEM8G
Replacement Battery	Battery life: 5 years (at 25°C). This Battery is provided as an accessory.	CJ1W-BAT01
Anti-reflection Sheets	For the NA5-15W. Attach a Sheet to the screen to protect against diffused reflections and dirt. The entire Sheet is colorless and transparent. Five Sheets are provided in one set.	NA-15WKBA04
	For the NA5-12W. Attach a Sheet to the screen to protect against diffused reflections and dirt. The entire Sheet is colorless and transparent. Five Sheets are provided in one set.	NA-12WKBA04
	For the NA5-9W. Attach a Sheet to the screen to protect against diffused reflections and dirt. The entire Sheet is colorless and transparent. Five Sheets are provided in one set.	NA-9WKBA04
	For the NA5-7W. Attach a Sheet to the screen to protect against diffused reflections and dirt. The entire Sheet is colorless and transparent. Five Sheets are provided in one set.	NA-7WKBA04

#### Automation Software

Product name	Specifications	Number of licenses	Media	Model
Sysmac Studio Standard Edition Ver.1.□□	The Sysmac Studio is the software that provides an integrated environment for setting, programming, debugging and maintenance of machine automation controllers including the NJ/NX Series, EtherCAT Slave, and the HMI. Sysmac Studio runs on the following OS. Windows XP (Service Pack 3 or higher, 32-bit version) / Windows Vista (32-bit version) / Windows 7 (32-bit/64-bit version) / Windows 8 (32-bit/64-bit version) / Windows 8.1 (32-bit/64-bit version)	– (Media only)	DVD	SYSMAC-SE200D
		1 license	–	SYSMAC-SE201L
		3 licenses		SYSMAC-SE203L
		10 licenses		SYSMAC-SE210L
		30 licenses		SYSMAC-SE230L
		50 licenses		SYSMAC-SE250L

Note: Site licenses are available for users who will run Sysmac Studio on multiple computers. Ask your OMRON sales representative for details.

#### USB Cable

Product name	Specifications
USB Cable	Use commercially available USB cable. Specifications: USB 2.0 cable (A connector - B connector), 5.0 m max.

## Ordering Information

### Recommended Network Devices

#### Industrial Switching Hubs

Product name	Specifications					Model
	Functions	No. of ports	Failure detection	Accessories	Current consumption (A)	
Industrial Switching Hubs	Quality of Service (QoS): EtherNet/IP control data priority Failure detection: Broadcast storm and LSI error detection 10/100BASE-TX, Auto-Negotiation	3	No	Power supply connector	0.22	W4S1-03B
		5	No	• Power supply connector • Connector for informing error	0.22	W4S1-05B
		5	Yes		0.22	W4S1-05C

### Recommended Ethernet Communications Cables

Use STP (shielded twisted-pair) cable of category 6A or higher

Appearance	Type	Cable Sheath Material	Part Number	Length in inch (cm)	xx = Length	y = Color
	Category 6A Cable with Connectors on Both Ends (RJ45/RJ45)	LOW Smoke Zero Halogen (LSZH)	XS6W-6LSZH8SSxxCM-y	7.87 (20)	20	B = Blue Y = Yellow G = Green
				11.8 (30)	30	
				19.6 (50)	50	
				39.4 (100)	100	
				59.0 (150)	150	
				78.7 (200)	200	
				118 (300)	300	
				196 (500)	500	
				295 (750)	750	
				393 (1000)	1000	
				590 (1500)	1500	
787 (2000)	2000					

**Example:** XS6W-6LSZH8SS100CMB = CAT6A cable with RJ45 connectors at both ends 39.4 inch (100 cm) long, Blue

# NA Series

## Performance Specifications

NA5-□W and NA5-□U have the same specifications and performance characteristics of hardware and software.

### Display

Item	Specification				
	NA5-15W	NA5-12W	NA5-9W	NA5-7W	
Display panel #1	Display device	TFT LCD			
	Screen size	15.4 inches	12.1 inches	9.0 inches	7.0 inches
	Resolution	1,280 × 800 dots (horizontal × vertical)		800 × 480 dots (horizontal × vertical)	
	Colors	16,770,000 colors (24 bit full colors)			
	Effective display area	331 × 207 mm (horizontal × vertical)	261 × 163 mm (horizontal × vertical)	197 × 118 mm (horizontal × vertical)	152 × 91 mm (horizontal × vertical)
Backlight #2	View angles	Left: 60°, Right: 60°, Top: 60°, Bottom: 60°			
	Life	50,000 hours min. #3			
Front panel indicators #4	Brightness adjustment	200 levels			
	RUN	Lit green: Normal operation		Lit red: Error	

\*1. There may be some defective pixels in the display. This is not a fault as long as the numbers of defective light and dark pixels fall within the following standard ranges.

Model	Standard range
NA5-15W□□□□	Number of light and dark pixels: 10 or less. (There must not be 3 consecutive light/dark pixels.)
NA5-12W□□□□	
NA5-9W□□□□	
NA5-7W□□□□	

\*2. The backlight can be replaced at an OMRON maintenance base.

\*3. This is the estimated time before brightness is reduced by half at room temperature and humidity. The life expectancy is drastically shortened if Programmable Terminal is used at high temperatures.

\*4. The brightness of the front panel indicators is also adjustable when you adjust the brightness of the backlight.

### Operation

Item	Specification			
	NA5-15W	NA5-12W	NA5-9W	NA5-7W
Touch panel	Method: Analog resistance membrane (pressure sensitive)			
	Resolution: 16,384 × 16,384			
	Life: 1,000,000 operations			
Function keys *	3 inputs (capacitance inputs)			

\* Each function key has blue indicator. The brightness of the function key indicators is also adjustable when you adjust the brightness of the backlight.

### Data Capacity

Item	Specification			
	NA5-15W	NA5-12W	NA5-9W	NA5-7W
User data capacity	256 MB			

### External Interfaces

Item	Specifications (Same for all models.)	
Ethernet ports	Applications	Port 1: Connecting to anything other than the Sysmac Studio, e.g., device connections and VNC clients Port 2: Connecting to the Sysmac Studio in addition to the applications of port 1.
	Number of ports	2 ports
	Compliant standards	IEEE 802.3i (10BASE-T), IEEE 802.3u (100BASE-TX), and IEEE 802.3ab (1000Base-T)
	Transmission media	Shielded twisted-pair (STP) cable: Category 5, 5e, or higher
	Transmission distance	100 m
USB host ports	Connector	RJ-45 8P8C modular connector
	Applications	USB Memory Device, keyboard, or mouse
	Number of ports	2 ports
	Compliant standards	USB 2.0
USB slave port	Transmission distance	5 m max.
	Connector	Type-A connector
	Applications	Sysmac Studio connection
	Number of ports	1 port
Serial port *	Compliant standards	USB 2.0
	Transmission distance	5 m max.
	Connector	Type-B connector
	Applications	Device Connection
SD Memory Card slot	Number of ports	1 port
	Compliant standards	RS-232C
	Transmission distance	15 m max.
	Connector	D-DUB 9-pin female connector
Expansion Unit connector *	Applications	To transfer or store the project or to store log data.
	Number of slots	1 slot
	Compliant standards	SD/SDHC
Expansion Unit connector *	Applications	Expansion Unit
	Quantity	1

\* The serial port and Expansion Unit connector are for future expansion.



# General Specifications

Item	Specification			
	NA5-15W□□□□	NA5-12W□□□□	NA5-9W□□□□	NA5-7W□□□□
Rated supply voltage	24 VDC			
Allowable power supply voltage range	19.2 to 28.8 VDC (24 VDC ±20%)			
Allowable momentary power interruption time	Operation for momentary power interruption is not specified.			
Power consumption	47 W max.	45 W max.	40 W max.	35 W max.
Ambient operating temperature	32 to 122°F (0 to 50°C) *1 *2			
Ambient storage temperature	-4 to 140°F (-20 to 60°C) *3			
Ambient operating humidity	10 to 90% * 2 Must be no condensation.			
Atmosphere	Must be free from corrosive gases.			
Pollution degree	2 or less: JIS B 3502, IEC 61131-2			
Noise immunity	2 kV on power supply line (Conforms to IEC 61000-4-4.)			
Vibration resistance (during operation)	Conforms to IEC 60068-2-6. 5 to 8.4 Hz with 3.5 mm half amplitude and 8.4 to 150 Hz with 9.8 m/s <sup>2</sup> for 100 minutes each in X, Y, and Z directions (Time coefficient of 10 minutes × coefficient factor of 10 = total time of 100 min.)			
Shock resistance (during operation)	Conforms to IEC 60028-2-27. 147 m/s <sup>2</sup> 3 times each in X, Y, and Z directions			
Dimensions W x H x D in (mm)	16.5 x 11.5 x 2.7 (420 x 291 x 69)	13.4 x 9.6 x 2.7 (340 X 244 X 69)	11.4 x 7.5 x 2.7 (290 X 190 X 69)	9.3 x 6.9 x 2.7 (236 X 165 X 69)
Panel cutout dimensions (horizontal X vertical)	15.4 x 10.5 in <sup>+0.04</sup> (392 x 268 mm <sup>+1</sup> ) Panel thickness: .062 to .24 in (1.6 to 6.0 mm)	12.2 x 8.7 in <sup>+0.04</sup> (310 x 221 mm <sup>+1</sup> ) Panel thickness: .062 to .24 in (1.6 to 6.0 mm)	10.3 x 6.5 in <sup>+4</sup> (261 x 166 mm <sup>+1</sup> ) Panel thickness: .062 to .24 in (1.6 to 6.0 mm)	7.6 x 5.6 in <sup>+0.02</sup> (197 x 141 mm <sup>+0.5</sup> ) Panel thickness: .062 to .24 in (1.6 to 6.0 mm)
Weight	7.0 lb (3.2 kg) max.	5.0 lb (2.3 kg) max.	3.7 lb (1.7 kg) max.	2.9 lb (1.3 kg) max.
Degree of protection	Front-panel controls: IP65 oil-proof type, UL type 4X			
Battery life	Battery life: 5 years at 25°C The RTC will be backed up for 5 days after the battery runs low. The RTC will be backed up by a super capacitor for 5 minutes after removing the old battery. (This assumes that the power is first turned ON for at least 5 minutes and then turned OFF.)			
International standards	UL 508/CSA standard C22.2 No.142 * 4 EMC Directive (2004/108/EC) EN 61131-2:2007 Shipbuilding standards LR, DNV, and NK IP65 oil-proof, UL type 4X (front panel only) ANSI 12.12.01 Class 1 Division 2/CSA standard C22.2 RoHS Directive (2002/95/EC) KC Standards KN 61000-6-2:2012-06 for EMS and KN 61000-6-4:2012-06 for EMI RCM			

- \*1. The ambient operating temperature is subject to the following restrictions, depending on the mounting angle.
- The ambient operating temperature is 0° to 40°C when the mounting angle is 0° or more and less than 45° to the horizontal.
  - The ambient operating temperature is 0° to 50°C when the mounting angle is 45° or more and 90° or less to the horizontal.
  - The ambient operating temperature is 0° to 50°C when the mounting angle is 90° or more and 135° or less to the horizontal.

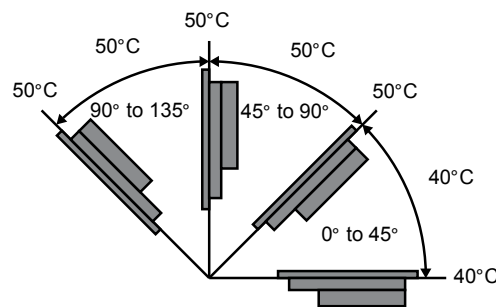

- \*2. Use the Programmable Terminal within the following temperature and humidity ranges.

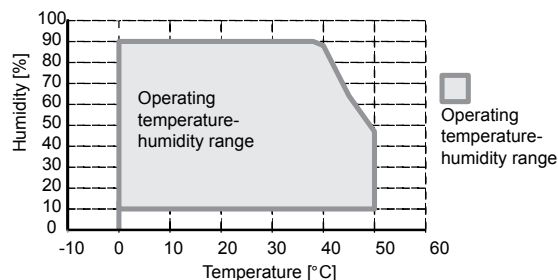

- \*3. Store the Programmable Terminal within the following temperature and humidity ranges.

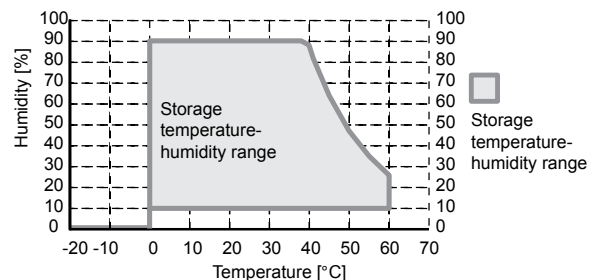

- \*4. Use power supply Class 2 to conform to UL Standards.

# NA Series

## Version Information



NA series and Programming Devices

NA series		Corresponding unit versions/version	
Model	NA system version	NJ/NX-series CPU Units NX701-□□□□ NJ501-□□□□ NJ301-□□□□ NJ101-□□□□	Sysmac studio
NA5-15W NA5-12W NA5-9W NA5-7W	1.02 or later	NX701: 1.10 or later NJ101: 1.10 or later	1.13 or higher
	1.01 or later	NJ501 : 1.01 or later NJ501 Database Connection : 1.05 or later NJ301 : 1.01 or later	1.11 or higher

## Components and Functions

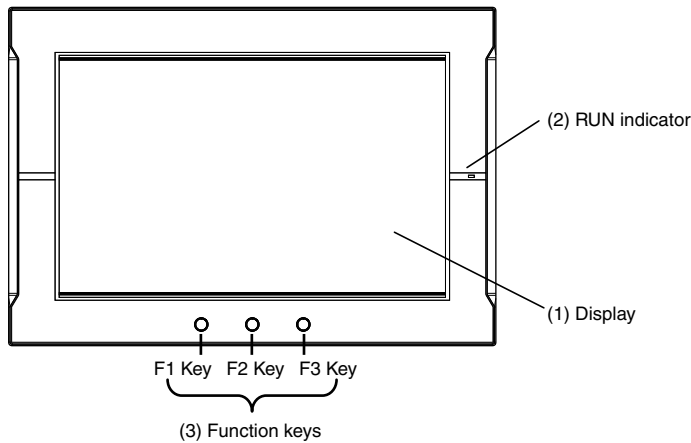
### Front Panel



No.	Name	Description
(1)	Display	The entire display is a touch panel that also functions as an input device.
(2)	RUN indicator	The status of the indicator changes according to the status of the NA.
(3)	Function keys	<p>There are three function keys: F1, F2, and F3.</p> <p> : F1 Key,  : F2 Key,  : F3 Key</p> <p>You can use the function keys as execution conditions for the actions for global or page events. You can also use the function keys for interlocks.</p>

# Components and Functions

## Back Panel

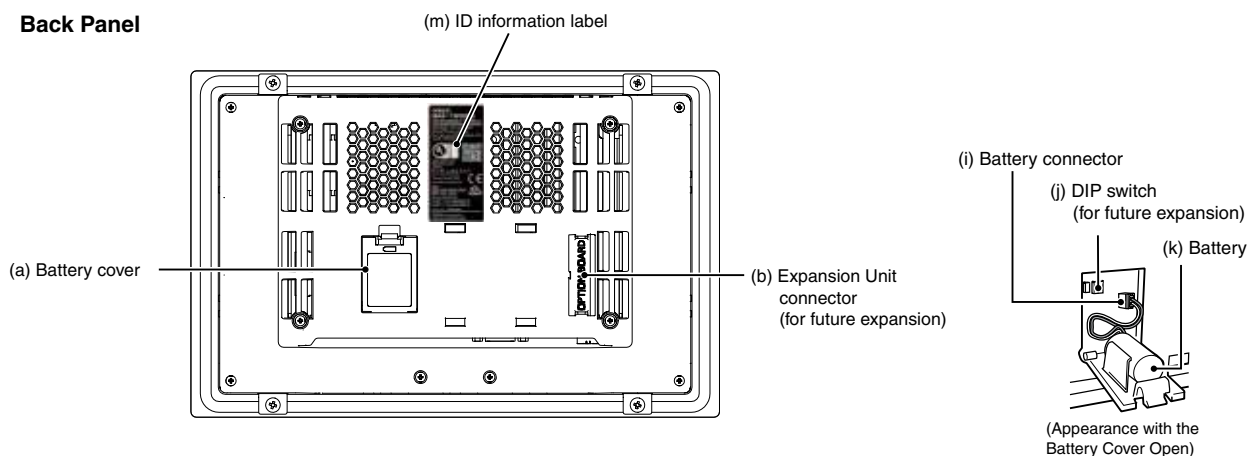

## Bottom Panel

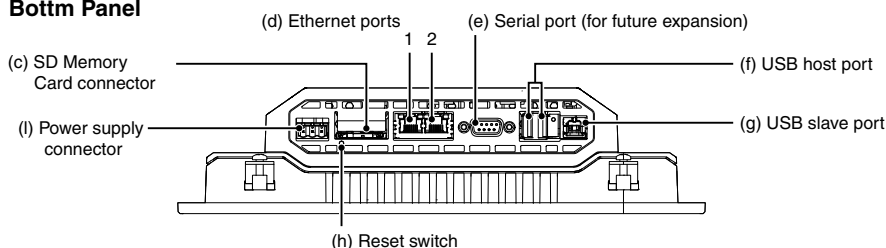

No.	Name	Description
(a)	Battery cover	Open this cover to replace the Battery.
(b)	Expansion Unit connector *	For future expansion.
(c)	SD Memory Card connector	Insert an SD Memory Card here.
(d)	Ethernet port 1	Connect a device other than the Sysmac Studio.
	Ethernet port 2	Connect mainly the Sysmac Studio.
(e)	Serial port *	For future expansion.
(f)	USB host port	Connect this port to a USB Memory Device, mouse, etc.
(g)	USB slave port	Connect the Sysmac Studio or other devices.
(h)	Reset switch	Use this switch to reset the NA.
(i)	Battery connector	Connect the connector on the backup Battery here.
(j)	DIP switch *	For future expansion. (The DIP switch is on a PCB that is accessed by opening the Battery cover.) Do not change any of the factory settings of the pins on the DIP switch. (Default setting: OFF)
(k)	Battery	This is the battery to backup the clock information in the NA.
(l)	DC input terminals	These are the power supply terminals. Connect the accessory power supply connector and supply power.
(m)	ID information label	You can check the ID information of the NA.

\* The DIP switch, Expansion Unit connector, and serial port are for future expansion.

## Supported Devices

Manufacturer	Models	Connection method	Communications driver
OMRON	NX701-□□□□ NJ501-□□□□ NJ301-□□□□ NJ101-□□□□	Built-in EtherNet/IP port	Ethernet
	CJ2H-CPU64/65/66/67/68-EIP CJ2M-CPU31/32/33/34/35	Built-in EtherNet/IP port	CIP Ethernet
	CJ2H-CPU64/65/66/67/68-EIP CJ2M-CPU31/32/33/34/35	CJ1W-EIP21	
	CJ2H-CPU64/65/66/67/68-EIP CJ2M-CPU31/32/33/34/35	Built-in EtherNet/IP port	FINS Ethernet
	CJ1H-CPU65H/66H/67H CJ1H-CPU65H/66H/67H-R CJ1G-CPU42H/43H/44H/45H CJ1M-CPU11/12/13/21/22/23 CJ2H-CPU64/65/66/67/68(-EIP) CJ2M-CPU11/12/13/14/15 CJ2M-CPU31/32/33/34/35	CJ1W-ETN21 CJ1W-EIP21	

Dimensions

Unit: inches [mm]

NA5-15W101S/-15W101B

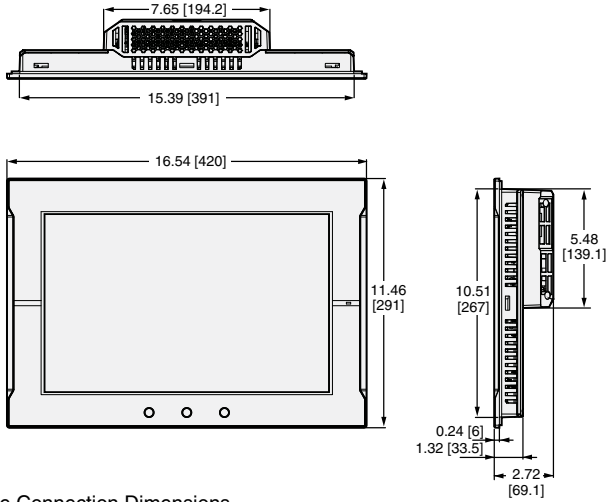

Cable Connection Dimensions

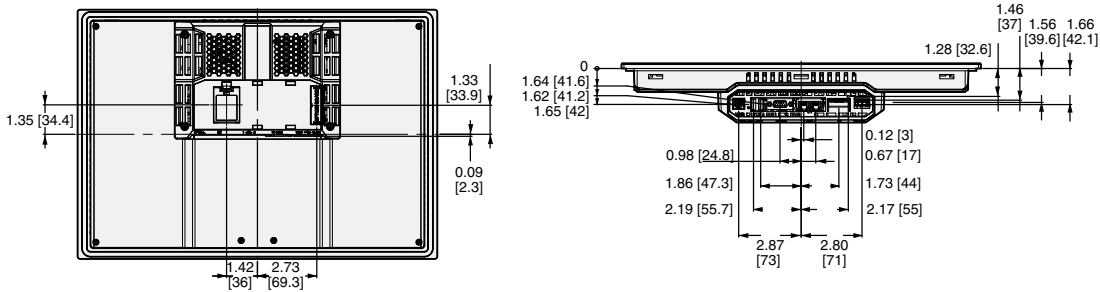

NA5-12W101S/-12W101B

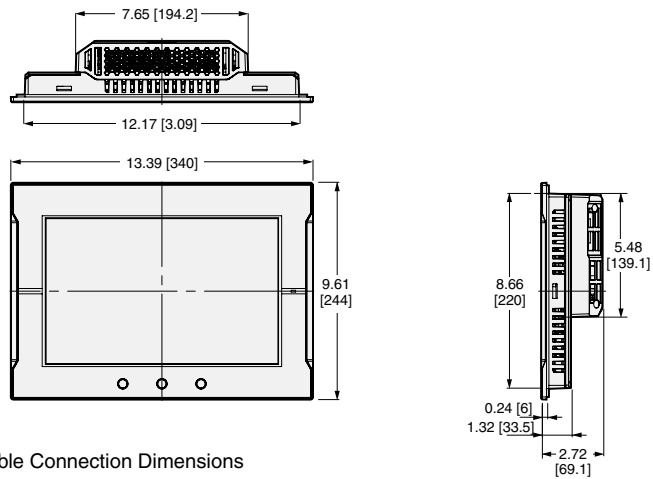

Cable Connection Dimensions

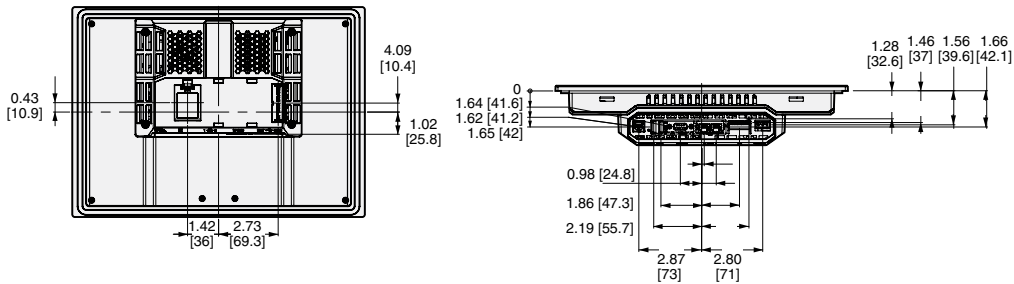

Dimensions

Unit: inches [mm]

NA5-9W001S/-9W001B

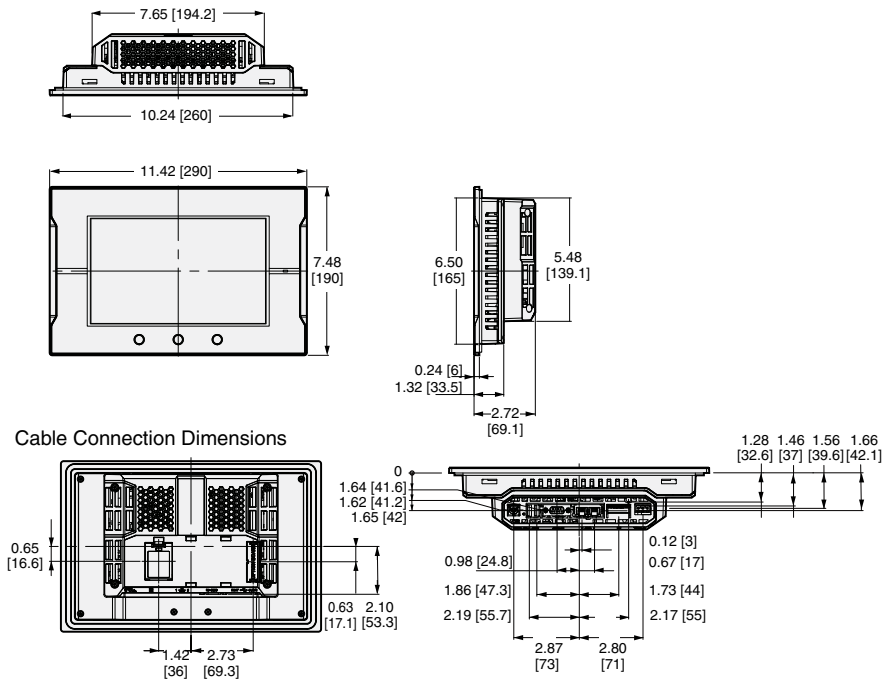

NA5-7W001S/-7W001B

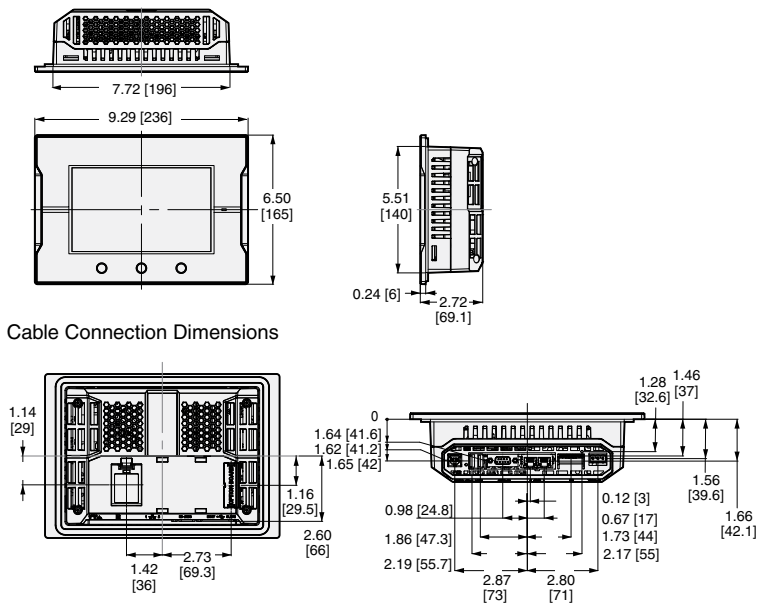

## NA Series

### Related Manuals

Cat. No.	Model number	Manual
V117	NA5-15W□□□□ NA5-12W□□□□ NA5-9W□□□□ NA5-7W□□□□	NA-series Programmable Terminal Hardware User's Manual
V118	NA5-15W□□□□ NA5-12W□□□□ NA5-9W□□□□ NA5-7W□□□□	NA-series Programmable Terminal Software User's Manual
V119	NA5-15W□□□□ NA5-12W□□□□ NA5-9W□□□□ NA5-7W□□□□	NA-series Programmable Terminal Device Connection User's Manual
V120	NA5-15W□□□□ NA5-12W□□□□ NA5-9W□□□□ NA5-7W□□□□	NA-series Programmable Terminal Startup Guide



**OMRON AUTOMATION AMERICAS HEADQUARTERS** • Chicago, IL USA • 847.843.7900 • 800.556.6766 • [www.omron247.com](http://www.omron247.com)

**OMRON CANADA, INC. • HEAD OFFICE**

Toronto, ON, Canada • 416.286.6465 • 866.986.6766 • [www.omron247.com](http://www.omron247.com)

**OMRON ELECTRONICS DE MEXICO • HEAD OFFICE**

México DF • 52.55.59.01.43.00 • 01-800-226-6766 • [mela@omron.com](mailto:mela@omron.com)

**OMRON ELECTRONICS DE MEXICO • SALES OFFICE**

Apodaca, N.L. • 52.81.11.56.99.20 • 01-800-226-6766 • [mela@omron.com](mailto:mela@omron.com)

**OMRON ELETRÔNICA DO BRASIL LTDA • HEAD OFFICE**

São Paulo, SP, Brasil • 55.11.2101.6300 • [www.omron.com.br](http://www.omron.com.br)

**OMRON ARGENTINA • SALES OFFICE**

Cono Sur • 54.11.4783.5300

**OMRON CHILE • SALES OFFICE**

Santiago • 56.9.9917.3920

**OTHER OMRON LATIN AMERICA SALES**

54.11.4783.5300

**OMRON EUROPE B.V.** • Wegalaan 67-69, NL-2132 JD, Hoofddorp, The Netherlands. • +31 (0) 23 568 13 00 • [www.industrial.omron.eu](http://www.industrial.omron.eu)

*Authorized Distributor:*

**Automation Control Systems**

- Machine Automation Controllers (MAC) • Programmable Controllers (PLC)
- Operator interfaces (HMI) • Distributed I/O • Software

**Drives & Motion Controls**

- Servo & AC Drives • Motion Controllers & Encoders

**Temperature & Process Controllers**

- Single and Multi-loop Controllers

**Sensors & Vision**

- Proximity Sensors • Photoelectric Sensors • Fiber-Optic Sensors
- Amplified Photomicrosensors • Measurement Sensors
- Ultrasonic Sensors • Vision Sensors

**Industrial Components**

- RFID/Code Readers • Relays • Pushbuttons & Indicators
- Limit and Basic Switches • Timers • Counters • Metering Devices
- Power Supplies

**Safety**

- Laser Scanners • Safety Mats • Edges and Bumpers • Programmable Safety Controllers • Light Curtains • Safety Relays • Safety Interlock Switches