

Machine Automation Controller NJ/NX-series

Startup Guide for Motion Control

NX1P2-□□□□

NX701-□□□□

NJ501-□□□□

NJ301-□□□□

NJ101-□□□□

SYSMAC-SE20□□

R88M-1□

R88D-1SN□-ECT

Startup
Guide



NOTE

All rights reserved. No part of this publication may be reproduced, stored in a retrieval system, or transmitted, in any form, or by any means, mechanical, electronic, photocopying, recording, or otherwise, without the prior written permission of OMRON.

No patent liability is assumed with respect to the use of the information contained herein. Moreover, because OMRON is constantly striving to improve its high-quality products, the information contained in this manual is subject to change without notice. Every precaution has been taken in the preparation of this manual. Nevertheless, OMRON assumes no responsibility for errors or omissions. Neither is any liability assumed for damages resulting from the use of the information contained in this publication.

Trademarks

- Sysmac and SYSMAC are trademarks or registered trademarks of OMRON Corporation in Japan and other countries for OMRON factory automation products.
- Windows is either a registered trademark or a trademark of Microsoft Corporation in the United States and other countries.
- EtherCAT® is registered trademark and patented technology, licensed by Beckhoff Automation GmbH, Germany.
- Celeron, Intel, and Intel Core are trademarks of Intel Corporation or its subsidiaries in the U.S. and/or other countries.
- Microsoft product screen shots reprinted with permission from Microsoft Corporation.

Other company names and product names in this document are the trademarks or registered trademarks of their respective companies.

Introduction

Thank you for purchasing an NJ/NX-series CPU Unit and the Sysmac Studio.

This *NJ/NX-series Startup Guide for Motion Control* (hereafter referred to as “this Guide”) describes the startup procedures that are required to use the NJ/NX-series Motion Control Function Module for the first time and provides operating instructions for the Sysmac Studio. You can follow the procedures that are given in this Guide to set axis parameters and perform simple one-axis positioning and two-axis linear interpolation. This Guide does not contain safety information and other details that are required for actual use of an NJ/NX-series Controller. Thoroughly read and understand the manuals for all of the devices that are used in this Guide to ensure that the system is used safely. Review the entire contents of these materials, including all safety precautions, precautions for safe use, and precautions for correct use.

For the startup and operating instructions for NJ/NX-series CPU Units, refer to the *NJ/NX-series Startup Guide for CPU Units* (Cat. No. W513).

Intended Audience

This Guide is intended for the following personnel, who must also have knowledge of electrical systems (an electrical engineer or the equivalent).

- Personnel in charge of introducing FA systems.
- Personnel in charge of designing FA systems.
- Personnel in charge of installing and maintaining FA systems.

Applicable Products

This Guide covers the following products.

- CPU Units of NJ/NX-series Machine Automation Controllers
- Sysmac Studio Automation Software

Special Information

The icons that are used in this Guide are described below.



Precautions for Safe Use

Precautions on what to do and what not to do to ensure safe usage of the product.



Precautions for Correct Use

Precautions on what to do and what not to do to ensure proper operation and performance.



Additional Information

Additional information to read as required.

This information is provided to increase understanding or make operation easier.

Terms and Conditions Agreement

CPU Units of NJ/NX-series Machine Automation Controllers

Warranty, Limitations of Liability

Warranties

- **Exclusive Warranty**

Omron's exclusive warranty is that the Products will be free from defects in materials and workmanship for a period of twelve months from the date of sale by Omron (or such other period expressed in writing by Omron). Omron disclaims all other warranties, express or implied.

- **Limitations**

OMRON MAKES NO WARRANTY OR REPRESENTATION, EXPRESS OR IMPLIED, ABOUT NON-INFRINGEMENT, MERCHANTABILITY OR FITNESS FOR A PARTICULAR PURPOSE OF THE PRODUCTS. BUYER ACKNOWLEDGES THAT IT ALONE HAS DETERMINED THAT THE PRODUCTS WILL SUITABLY MEET THE REQUIREMENTS OF THEIR INTENDED USE.

Omron further disclaims all warranties and responsibility of any type for claims or expenses based on infringement by the Products or otherwise of any intellectual property right.

- **Buyer Remedy**

Omron's sole obligation hereunder shall be, at Omron's election, to (i) replace (in the form originally shipped with Buyer responsible for labor charges for removal or replacement thereof) the non-complying Product, (ii) repair the non-complying Product, or (iii) repay or credit Buyer an amount equal to the purchase price of the non-complying Product; provided that in no event shall Omron be responsible for warranty, repair, indemnity or any other claims or expenses regarding the Products unless Omron's analysis confirms that the Products were properly handled, stored, installed and maintained and not subject to contamination, abuse, misuse or inappropriate modification. Return of any Products by Buyer must be approved in writing by Omron before shipment. Omron Companies shall not be liable for the suitability or unsuitability or the results from the use of Products in combination with any electrical or electronic components, circuits, system assemblies or any other materials or substances or environments. Any advice, recommendations or information given orally or in writing, are not to be construed as an amendment or addition to the above warranty.

See <http://www.omron.com/global/> or contact your Omron representative for published information.

Limitation on Liability; Etc

OMRON COMPANIES SHALL NOT BE LIABLE FOR SPECIAL, INDIRECT, INCIDENTAL, OR CONSEQUENTIAL DAMAGES, LOSS OF PROFITS OR PRODUCTION OR COMMERCIAL LOSS IN ANY WAY CONNECTED WITH THE PRODUCTS, WHETHER SUCH CLAIM IS BASED IN CONTRACT, WARRANTY, NEGLIGENCE OR STRICT LIABILITY.

Further, in no event shall liability of Omron Companies exceed the individual price of the Product on which liability is asserted.

Application Considerations

Suitability of Use

Omron Companies shall not be responsible for conformity with any standards, codes or regulations which apply to the combination of the Product in the Buyer's application or use of the Product. At Buyer's request, Omron will provide applicable third party certification documents identifying ratings and limitations of use which apply to the Product. This information by itself is not sufficient for a complete determination of the suitability of the Product in combination with the end product, machine, system, or other application or use. Buyer shall be solely responsible for determining appropriateness of the particular Product with respect to Buyer's application, product or system. Buyer shall take application responsibility in all cases.

NEVER USE THE PRODUCT FOR AN APPLICATION INVOLVING SERIOUS RISK TO LIFE OR PROPERTY WITHOUT ENSURING THAT THE SYSTEM AS A WHOLE HAS BEEN DESIGNED TO ADDRESS THE RISKS, AND THAT THE OMRON PRODUCT(S) IS PROPERLY RATED AND INSTALLED FOR THE INTENDED USE WITHIN THE OVERALL EQUIPMENT OR SYSTEM.

Programmable Products

Omron Companies shall not be responsible for the user's programming of a programmable Product, or any consequence thereof.

Disclaimers

Performance Data

Data presented in Omron Company websites, catalogs and other materials is provided as a guide for the user in determining suitability and does not constitute a warranty. It may represent the result of Omron's test conditions, and the user must correlate it to actual application requirements. Actual performance is subject to the Omron's Warranty and Limitations of Liability.

Change in Specifications

Product specifications and accessories may be changed at any time based on improvements and other reasons. It is our practice to change part numbers when published ratings or features are changed, or when significant construction changes are made. However, some specifications of the Product may be changed without any notice. When in doubt, special part numbers may be assigned to fix or establish key specifications for your application. Please consult with your Omron's representative at any time to confirm actual specifications of purchased Product.

Errors and Omissions

Information presented by Omron Companies has been checked and is believed to be accurate; however, no responsibility is assumed for clerical, typographical or proofreading errors or omissions.

Sysmac Studio Automation Software

● WARRANTY

- The warranty period for the Software is one year from the date of purchase, unless otherwise specifically agreed.
- If the User discovers defect of the Software (substantial non-conformity with the manual), and return it to OMRON within the above warranty period, OMRON will replace the Software without charge by offering media or download from OMRON's website. And if the User discovers defect of media which is attributable to OMRON and return it to OMRON within the above warranty period, OMRON will replace defective media without charge. If OMRON is unable to replace defective media or correct the Software, the liability of OMRON and the User's remedy shall be limited to the refund of the license fee paid to OMRON for the Software.

● LIMITATION OF LIABILITY

- THE ABOVE WARRANTY SHALL CONSTITUTE THE USER'S SOLE AND EXCLUSIVE REMEDIES AGAINST OMRON AND THERE ARE NO OTHER WARRANTIES, EXPRESSED OR IMPLIED, INCLUDING BUT NOT LIMITED TO, WARRANTY OF MERCHANTABILITY OR FITNESS FOR PARTICULAR PURPOSE. IN NO EVENT, OMRON WILL BE LIABLE FOR ANY LOST PROFITS OR OTHER INDIRECT, INCIDENTAL, SPECIAL OR CONSEQUENTIAL DAMAGES ARISING OUT OF USE OF THE SOFTWARE.
- OMRON SHALL HAVE NO LIABILITY FOR DEFECT OF THE SOFTWARE BASED ON MODIFICATION OR ALTERNATION TO THE SOFTWARE BY THE USER OR ANY THIRD PARTY.
- OMRON SHALL HAVE NO LIABILITY FOR SOFTWARE DEVELOPED BY THE USER OR ANY THIRD PARTY BASED ON THE SOFTWARE OR ANY CONSEQUENCE THEREOF.

● APPLICABLE CONDITIONS

USER SHALL NOT USE THE SOFTWARE FOR THE PURPOSE THAT IS NOT PROVIDED IN THE ATTACHED USER MANUAL.

● CHANGE IN SPECIFICATION

The software specifications and accessories may be changed at any time based on improvements and other reasons.

● ERRORS AND OMISSIONS

The information in this manual has been carefully checked and is believed to be accurate; however, no responsibility is assumed for clerical, typographical, or proofreading errors, or omissions.

Precautions

- When building a system, check the specifications for all devices and equipment that will make up the system and make sure that the OMRON products are used well within their rated specifications and performances. Safety measures, such as safety circuits, must be implemented in order to minimize the risks in the event of a malfunction.
- Thoroughly read and understand the manuals for all devices and equipment that will make up the system to ensure that the system is used safely. Review the entire contents of these materials, including all safety precautions, precautions for safe use, and precautions for correct use.
- Confirm all regulations, standards, and restrictions that the equipment and devices in the system must adhere to.

Software Licenses and Copyrights

This product incorporates certain third party software. The license and copyright information associated with this software is available at http://www.fa.omron.co.jp/nj_info_e/.

Related Manuals

The following manuals are related to the NJ/NX-series Controllers. Use these manuals for reference.

Manual name	Cat. No.	Model	Application	Meaning
NX-series NX1P2 CPU Unit Hardware User's Manual	W578	NX1P2-□□□□	Learning the basic specifications of the NX-series NX1P2 CPU Units, including introductory information, designing, installation, and maintenance. Mainly hardware information is provided.	An introduction to the entire NX1P2 CPU Unit system is provided along with the following information on the NX1P2 CPU Unit. <ul style="list-style-type: none"> • Features and system configuration • Introduction • Part names and functions • General specifications • Installation and wiring • Maintenance and inspection
NX-series NX1P2 CPU Unit Built-in I/O and Option Board User's Manual	W579	NX1P2-□□□□	Learning about the details of functions only for an NX-series NX1P2 CPU Unit and an introduction of functions for an NJ/NX-series CPU Unit.	Of the functions for an NX1P2 CPU Unit, the following information is provided. <ul style="list-style-type: none"> • Built-in I/O • Serial Communication Option Boards • Analog I/O Option Boards An introduction of following functions for an NJ/NX-series CPU Unit is also provided. <ul style="list-style-type: none"> • Motion control functions • EtherNet/IP communications functions • EtherCAT communications functions
NX-series CPU Unit Hardware User's Manual	W535	NX701-□□□□	Learning the basic specifications of the NX701 CPU Units, including introductory information, designing, installation, and maintenance. Mainly hardware information is provided.	An introduction to the entire NX701 system is provided along with the following information on the CPU Unit. <ul style="list-style-type: none"> • Features and system configuration • Introduction • Part names and functions • General specifications • Installation and wiring • Maintenance and inspection Use this manual together with the <i>NJ/NX-series CPU Unit Software User's Manual</i> (Cat. No. W501).
NJ-series CPU Unit Hardware User's Manual	W500	NJ501-□□□□	Learning the basic specifications of the NJ-series CPU Units, including introductory information, designing, installation, and maintenance. Mainly hardware information is provided.	An introduction to the entire NJ-series system is provided along with the following information on a Controller built with an NJ501 CPU Unit. <ul style="list-style-type: none"> • Features and system configuration • Introduction • Part names and functions • General specifications • Installation and wiring • Maintenance and inspection Use this manual together with the <i>NJ/NX-series CPU Unit Software User's Manual</i> (Cat. No. W501).
NJ/NX-series CPU Unit Software User's Manual	W501	NX701-□□□□ NJ501-□□□□ NJ301-□□□□ NJ101-□□□□ NX1P2-□□□□	Learning how to program and set up an NJ/NX-series CPU Unit. Mainly software information is provided.	The following information is provided on a Controller built with an NJ/NX-series CPU Unit. <ul style="list-style-type: none"> • CPU Unit operation • CPU Unit features • Initial settings • Programming based on IEC 61131-3 language specifications Use this manual together with the <i>NJ-series CPU Unit Hardware User's Manual</i> (Cat. No. W500).

Manual name	Cat. No.	Model	Application	Meaning
NJ/NX-series CPU Unit Motion Control User's Manual	W507	NX701-□□□□ NJ501-□□□□ NJ301-□□□□ NJ101-□□□□ NX1P2-□□□□	Learning about motion control settings and programming concepts.	The settings and operation of the CPU Unit and programming concepts for motion control are described. When programming, use this manual together with the <i>NJ/NX-series CPU Unit Hardware User's Manual</i> (Cat. No. W500) and <i>NJ/NX-series CPU Unit Software User's Manual</i> (Cat. No. W501).
NJ/NX-series Instructions Reference Manual	W502	NX701-□□□□ NJ501-□□□□ NJ301-□□□□ NJ101-□□□□ NX1P2-□□□□	Learning detailed specifications on the basic instructions of an NJ/NX-series CPU Unit.	The instructions in the instruction set (IEC 61131-3 specifications) are described. When programming, use this manual together with the <i>NJ/NX-series CPU Unit Hardware User's Manual</i> (Cat. No. W500) and <i>NJ/NX-series CPU Unit Software User's Manual</i> (Cat. No. W501).
NJ/NX-series Motion Control Instructions Reference Manual	W508	NX701-□□□□ NJ501-□□□□ NJ301-□□□□ NJ101-□□□□ NX1P2-□□□□	Learning about the specifications of the motion control instructions.	The motion control instructions are described. When programming, use this manual together with the <i>NJ/NX-series CPU Unit Hardware User's Manual</i> (Cat. No. W500), <i>NJ/NX-series CPU Unit Software User's Manual</i> (Cat. No. W501) and <i>NJ/NX-series CPU Unit Motion Control User's Manual</i> (Cat. No. W507).
NJ/NX-series CPU Unit Built-in EtherCAT Port User's Manual	W505	NX701-□□□□ NJ501-□□□□ NJ301-□□□□ NJ101-□□□□ NX1P2-□□□□	Using the built-in EtherCAT port on an NJ/NX-series CPU Unit.	Information on the built-in EtherCAT port is provided. This manual provides an introduction and provides information on the configuration, features, and setup. Use this manual together with the <i>NJ/NX-series CPU Unit Hardware User's Manual</i> (Cat. No. W500) and <i>NJ/NX-series CPU Unit Software User's Manual</i> (Cat. No. W501).
NJ/NX-series Troubleshooting Manual	W503	NX701-□□□□ NJ501-□□□□ NJ301-□□□□ NJ101-□□□□ NX1P2-□□□□	Learning about the errors that may be detected in an NJ/NX-series Controller.	Concepts on managing errors that may be detected in an NJ/NX-series Controller and information on individual errors are described. Use this manual together with the <i>NJ/NX-series CPU Unit Hardware User's Manual</i> (Cat. No. W500) and <i>NJ/NX-series CPU Unit Software User's Manual</i> (Cat. No. W501).
Sysmac Studio Version 1 Operation Manual	W504	SYSMAC-SE2□□□	Learning about the operating procedures and functions of the Sysmac Studio.	The operating procedures of the Sysmac Studio are described.
AC Servomotors/Servo Drives 1S-series with Built-in EtherCAT® Communications User's Manual	I586	R88M-1□ R88D-1SN□-ECT	Learning how to use the Servomotors/Servo Drives with built-in EtherCAT Communications.	Describes the hardware, setup methods and functions of the Servomotors/Servo Drives with built-in EtherCAT Communications.
Servo System 1S-series Startup Guide	I823	R88M-1L□/-1M□ (AC Servomotors) R88D-1SN□-ECT (AC Servo Drives)	Gaining a basic understanding of a 1S-series AC Servomotors/Servo Drives.	Describes the procedures for installation and setup of a 1S-series AC Servo Drive.

Revision History

A manual revision code appears as a suffix to the catalog number on the front and back covers of the manual.

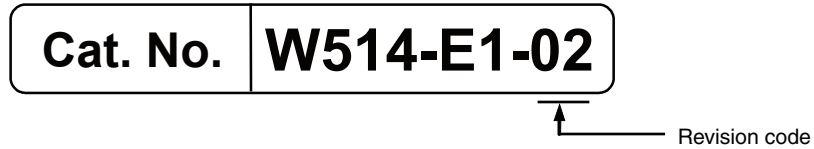

Revision code	Date	Revised content
01	November 2011	Original production
02	February 2017	Made changes accompanying the addition of NX1P2 CPU Units and 1S-series AC Servomotors / Servo Drivers

CONTENTS

Introduction	1
Intended Audience	1
Applicable Products	1
Special Information	1
Terms and Conditions Agreement.....	2
CPU Units of NJ/NX-series Machine Automation Controllers	2
Warranty, Limitations of Liability	2
Application Considerations	3
Disclaimers	3
Sysmac Studio Automation Software	4
Precautions.....	5
Software Licenses and Copyrights	5
Related Manuals	6
Revision History	8

Section 1 Features and System Configuration of NJ/NX-series Controllers and 1S-series AC Servo Systems

1-1 Features of NJ/NX Series and 1S Series	1-2
1-2 System Configuration and Configuration Devices.....	1-4
1-2-1 Devices Used in This Guide.....	1-4
1-2-2 Configuration of the System Constructed in This Guide	1-5

Section 2 Before You Begin

2-1 Installing the Sysmac Studio.....	2-2
2-2 Wiring the Devices.....	2-3
2-2-1 Wiring the NX1P CPU Unit Power Supply.....	2-3
2-2-2 Wiring the Servo Drive Power Supply	2-3
2-2-3 Laying EtherCAT Communications Cables	2-4
2-2-4 Wiring the Servo Drives and the Servomotors.....	2-5
2-2-5 Wiring the Control Input Signals for the Servo Drives.....	2-6

Section 3 Setting Up a Single-axis Servo System

3-1 Single-axis Servo System Operation	3-2
3-2 System Setup Procedures	3-3
3-3 Creating a Project.....	3-4
3-4 Creating the EtherCAT Network Configuration.....	3-7
3-5 Programming	3-9
3-5-1 Setting the Axis	3-9
3-5-2 Creating the Program.....	3-17
3-5-3 Checking the Program	3-27
3-6 Transferring the Project to the CPU Unit.....	3-28

3-7	Confirming System Operation.....	3-32
3-7-1	Checking for Controller Errors	3-32
3-7-2	Resetting the Absolute Encoder from the Sysmac Studio	3-35
3-7-3	Checking the Servo Drive Wiring.....	3-38
3-7-4	Checking Program Operation	3-44
3-7-5	Using Data Tracing to Check Operation	3-50

Section 4 Two-axis Linear Interpolation Program

4-1	Two-axis Servo System Operation.....	4-2
4-2	System Setup Procedures	4-3
4-3	Changing the Program.....	4-4
4-3-1	Setting Axis 0 to a Motion Control Axis.....	4-4
4-3-2	Adding a Servo Drive to the EtherCAT Network Configuration.....	4-5
4-3-3	Adding Axis 1 and Setting an Axes Group.....	4-7
4-3-4	Adding Instructions and Checking the Program	4-15
4-3-5	Transferring the Project to the CPU Unit.....	4-21
4-4	Confirming System Operation.....	4-22
4-4-1	Checking the New Axis 1	4-22
4-4-2	Checking Program Operation	4-22
4-4-3	Using Data Tracing to Check Operation	4-29

Appendices

A-1	Settings When Control Input Signals Are Not Wired	A-2
A-2	Using the 3D Motion Trace Display Mode to Check Operation	A-7

1

Features and System Configuration of NJ/NX-series Controllers and 1S-series AC Servo Systems

This section describes the configuration of the Servo system that is constructed in this Guide and the products that make up that system.

1-1	Features of NJ/NX Series and 1S Series	1-2
1-2	System Configuration and Configuration Devices	1-4
1-2-1	Devices Used in This Guide	1-4
1-2-2	Configuration of the System Constructed in This Guide	1-5

1-1 Features of NJ/NX Series and 1S Series

The NX/NJ-series Machine Automation Controllers provide advanced motion control previously executed by dedicated controllers or Special Units.
The CPU Units have a built-in EtherCAT port for real-time machine control.

Easy Wiring

Traditional System Using Position Control Units

Required substantial time for wiring work.
Any wiring errors also required time to check.

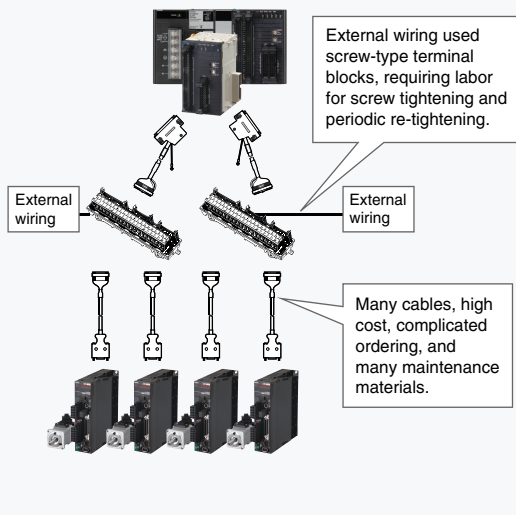

NX1P and 1S Series

Only one cable: easy connections and no mistakes!

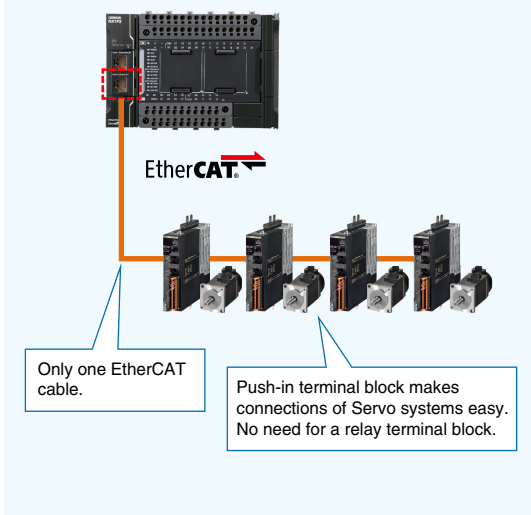

Easy Motion Programming

Traditional System Using Position Control Units

Three software were used for Position Control Unit settings, ladder programming, and Servo System settings respectively. You had to create a program while monitoring and tuning the settings.

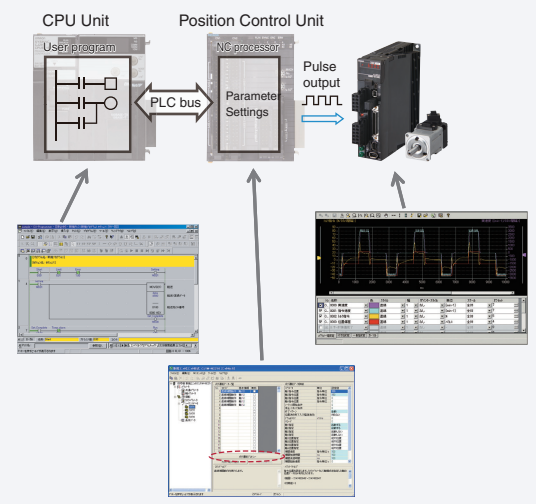

NX1P and 1S Series

The Sysmac Studio, which integrates ladder programming, motion, and configuration, facilitates positioning control. Simple monitoring and modification!

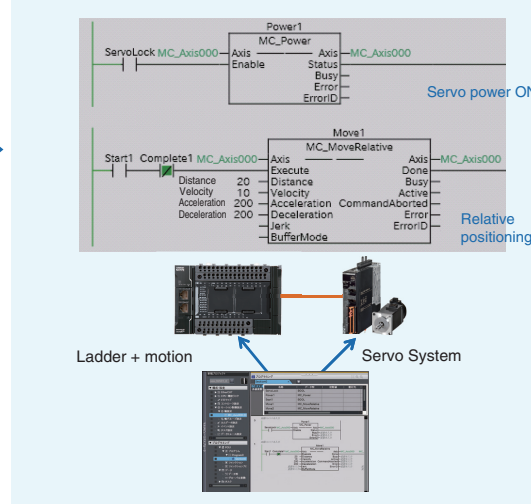

3D Simulation Makes Debugging Easy

Traditional System Using Position Control Units

The actual equipment was required to check operation during debugging.



NX1P and 1S Series

You can check 3D operation at your desk, shortening on-site debugging time. While viewing the programmed Servomotor path, you can review operation with the machine engineers prior to system completion and fix problems in advance!

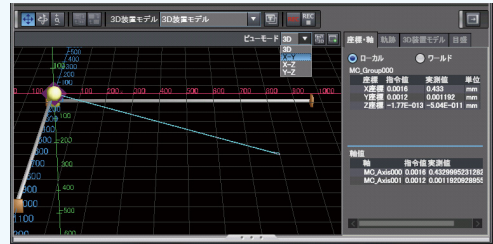

Fast Recovery after Power Interruptions with the Standard-feature Absolute Encoder

After an emergency stop or power interruption



Traditional Servo System Using Incremental Encoder

Homing operation was required to resume positioning because home information was cleared.

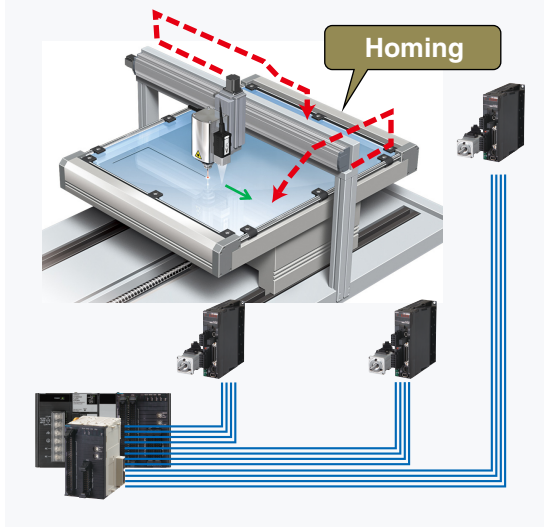





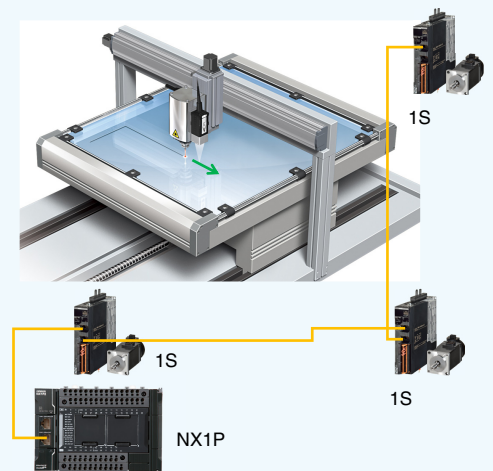



NX1P and 1S Series

Introducing an absolute encoder to the 1S-series Servomotor eliminates the need for homing operation, so you can resume positioning immediately. The battery-free encoder retains the absolute positions. No battery, no maintenance!

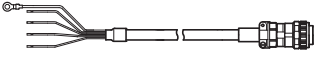

1-2 System Configuration and Configuration Devices

1-2-1 Devices Used in This Guide

		
<p align="center">NX1P Machine Automation Controller NX1P2-1140DT</p>	<p align="center">1S-series AC Servo Drive R88D-1SN01L-ECT</p>	<p align="center">1S-series AC Servomotor R88M-1M10030S</p>
		
<p align="center">EtherCAT Communications Cable XS5W-T421-□MD-K</p>	<p align="center">Motor Power Cable R88A-CA1A003S</p>	<p align="center">Encoder Cable R88A-CR1A003C</p>
		
<p align="center">Sysmac Studio Automation Software Standard Edition Version 1.17 or higher</p>	<p align="center">Ethernet Cable (100BASE-TX/10BASE-T)</p>	<p align="center">24 VDC Power Supply</p>
<p align="center">SYSMAC-SE200D (Media only) SYSMAC-SE201L (One license)</p>	<p align="center">---</p>	<p align="center">Example: S8VK-S</p>

1-2-2 Configuration of the System Constructed in This Guide

This *NJ/NX-series Startup Guide for Motion Control* (hereafter referred to as "this Guide") builds the Servo system in the following two steps.

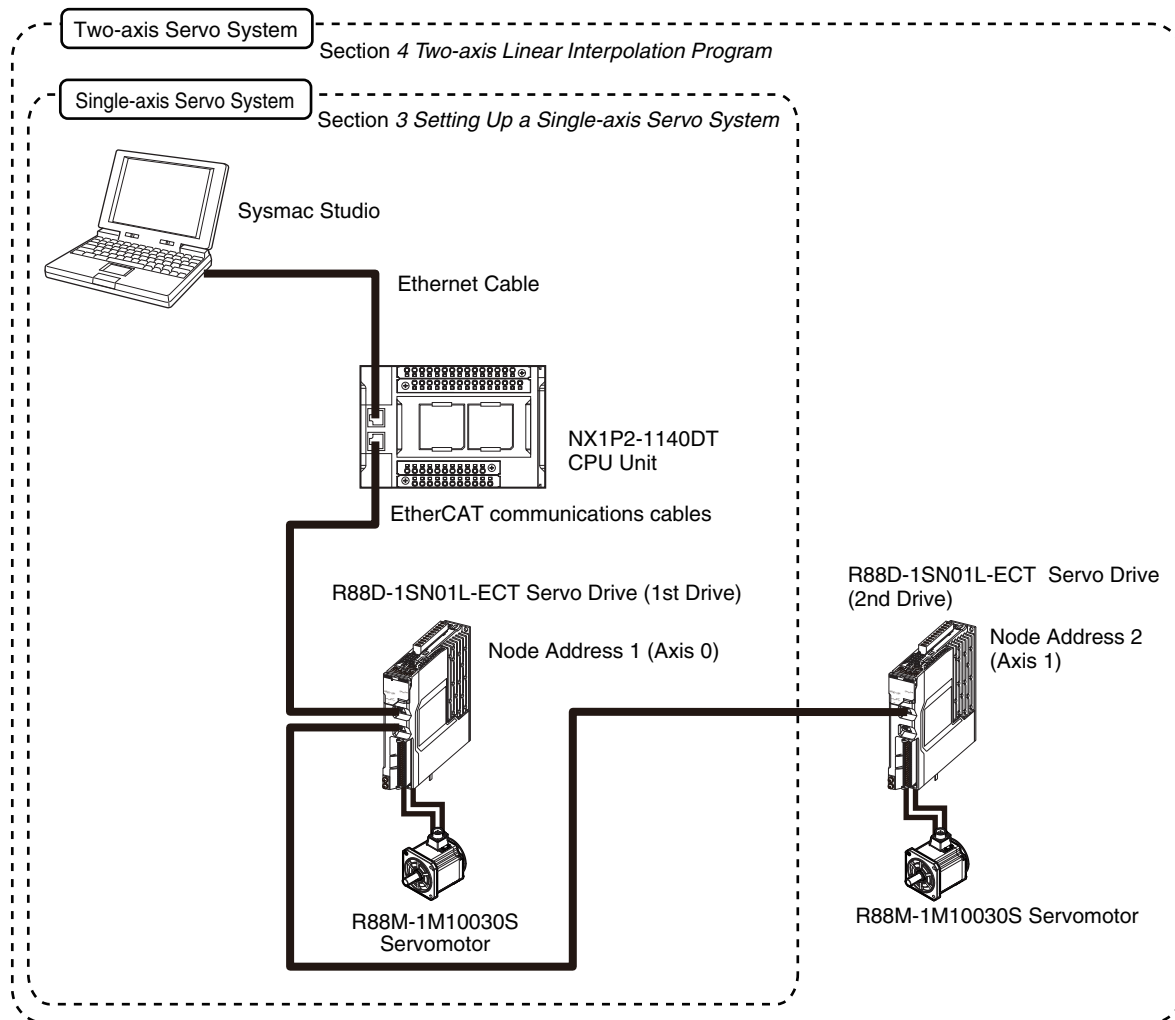

Single-axis Servo System

This system performs single-axis positioning using a Servo Drive and Servomotor for one axis. The steps from device wiring to software design and debugging are described.

Device connections are described in *Section 2 Before You Begin*, and software design and debugging are described in *Section 3 Setting Up a Single-axis Servo System*.

- **Positioning example:**

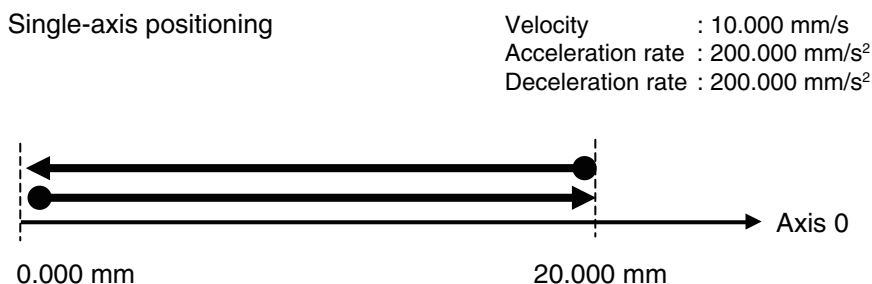

Two-axis Servo System

This system performs linear interpolation using Servo Drives and Servomotors for two axes. The steps from device wiring to software design and debugging are described.

Device connections are described in *Section 2 Before You Begin*, and software design and debugging are described in *Section 4 Two-axis Linear Interpolation Program*.

The NX1P2-9024DT/-9024DT1 cannot be used in this linear interpolation example.

Use the NX1P2-1040DT/-1040DT1, NX1P2-1140DT/-1140DT1, NJ-series CPU Unit, or NX7 CPU Unit.

● Positioning example:

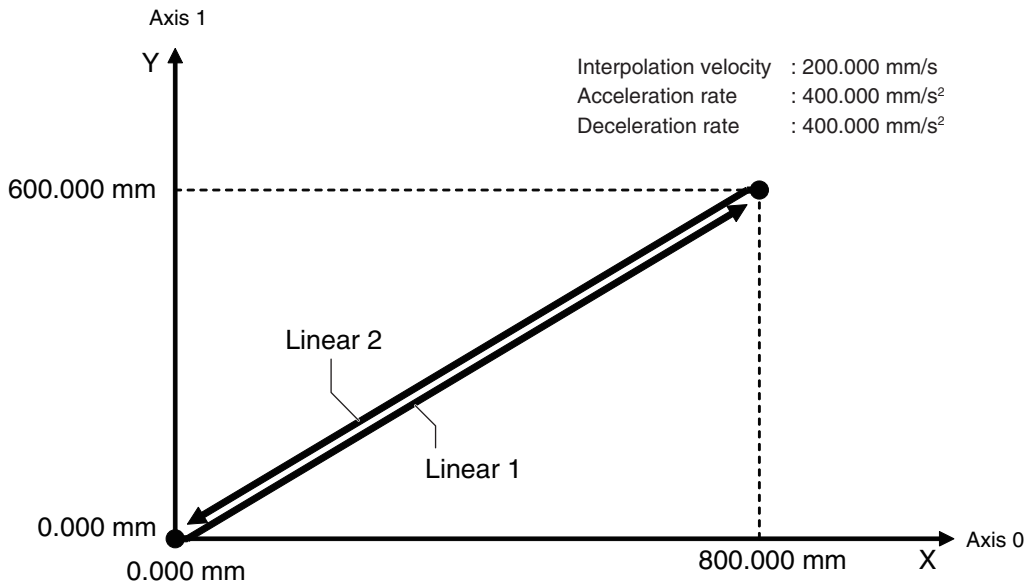



Before You Begin

This section describes the installation of the Sysmac Studio and the process of assembling and wiring the hardware.

2-1	Installing the Sysmac Studio	2-2
2-2	Wiring the Devices	2-3
2-2-1	Wiring the NX1P CPU Unit Power Supply	2-3
2-2-2	Wiring the Servo Drive Power Supply	2-3
2-2-3	Laying EtherCAT Communications Cables	2-4
2-2-4	Wiring the Servo Drives and the Servomotors	2-5
2-2-5	Wiring the Control Input Signals for the Servo Drives	2-6

2-1 Installing the Sysmac Studio

The Sysmac Studio is the Support Software that you use for an NJ/NX-series Controller. On it, you can create the Controller configuration and settings, you can write the programs, and you can debug and simulate operation.

Use the following procedure to install the Sysmac Studio.

- 1** Set the Sysmac Studio installation disk into the DVD-ROM drive.
The setup program is started automatically and the Select Setup Language Dialog Box is displayed.
- 2** Select the language to use, and then click the **OK** Button.
The Sysmac Studio Setup Wizard is started.
- 3** Follow the instructions given by the Setup Wizard to complete the installation.
- 4** Restart the computer when the installation is completed.



Additional Information

- The system requirements for the Sysmac Studio are given in the following table.

OS	CPU		RAM	Display
Windows 7 (32-bit or 64-bit edition) Windows 8 (32-bit or 64-bit edition)	Minimum	IBM AT or compatible with Intel® Celeron® processor 540 (1.8 GHz)	2 GB	XGA 1,024 × 768, 16 million colors
Windows 8.1 (32-bit or 64-bit edition) Windows 10 (32-bit or 64-bit edition)	Recommended	IBM AT or compatible with Intel® Core™ i5 M520 pro- cessor (2.4 GHz) or the equivalent	4 GB min.	WXGA 1,280 × 800, 16 million colors

- Refer to the *Sysmac Studio Version 1 Operation Manual* (Cat. No. W504) if you are unable to install the Sysmac Studio with the above instructions.



Precautions for Correct Use

If CX-One version 4 or lower is installed, the installation is cancelled and the Sysmac Studio cannot be installed. In that case, uninstall the CX-One before you install the Sysmac Studio.

2-2 Wiring the Devices

This section describes how to wire the assembled the hardware devices.

This section gives an overview of the wiring procedures. Refer to the manuals for the devices that are used in the system for detailed wiring procedures and safety precautions.

2-2-1 Wiring the NX1P CPU Unit Power Supply

Wire the CPU Unit to the DC power supply.

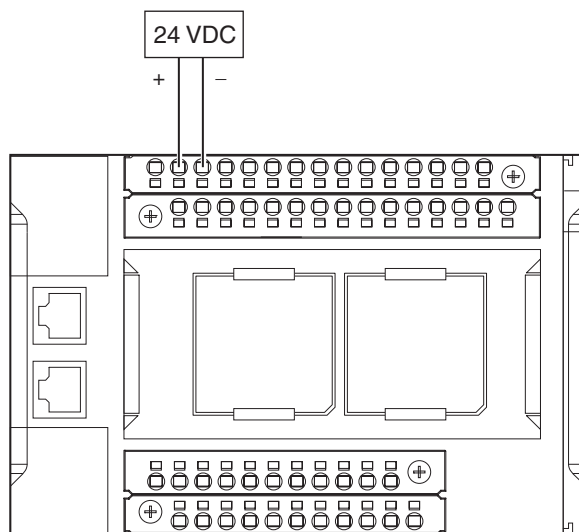

2-2-2 Wiring the Servo Drive Power Supply

Wire the Servo Drives to the power supply as shown in the following figure.

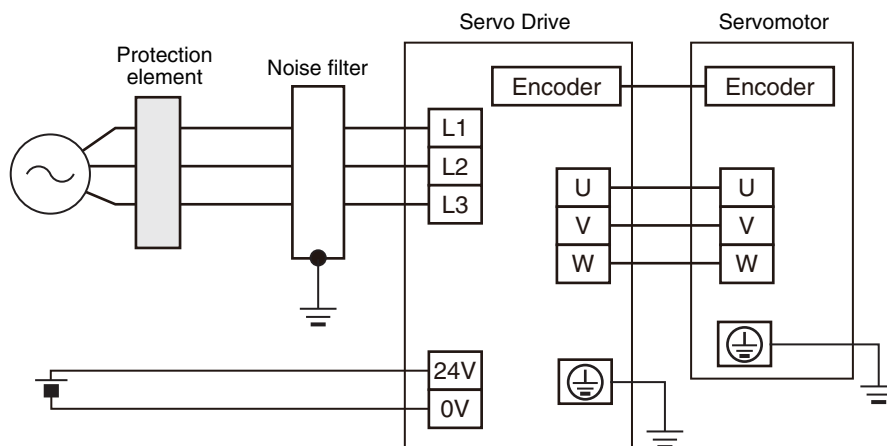

2-2-3 Laying EtherCAT Communications Cables

Connect the EtherCAT slave communications cables between the built-in EtherCAT port on the CPU Unit and the EtherCAT slaves as shown in the following figure. Connect the communications cable from the built-in EtherCAT port to the input port on the first slave, and then connect the communications cable to the next slave to the output port on the first slave. Do not connect anything to the output port of the slave at the end of the network.

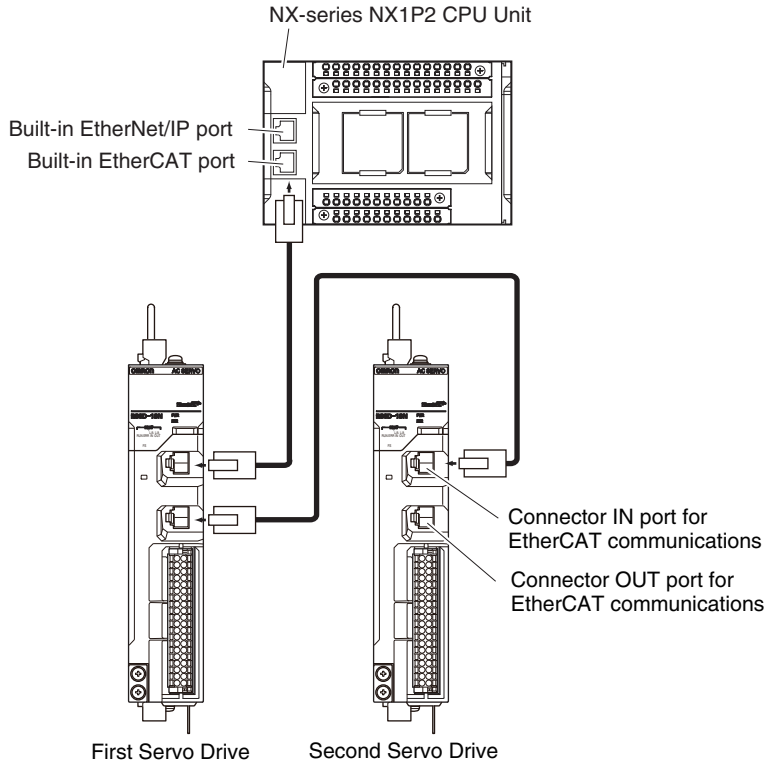

Setting the Node Addresses of the Servo Drives

Set the node addresses of the Servo Drives as shown below. Only the first Servo Drive is used in *Section 3 Setting Up a Single-axis Servo System*. The second Servo Drive is added in *Section 4 Two-axis Linear Interpolation Program*.

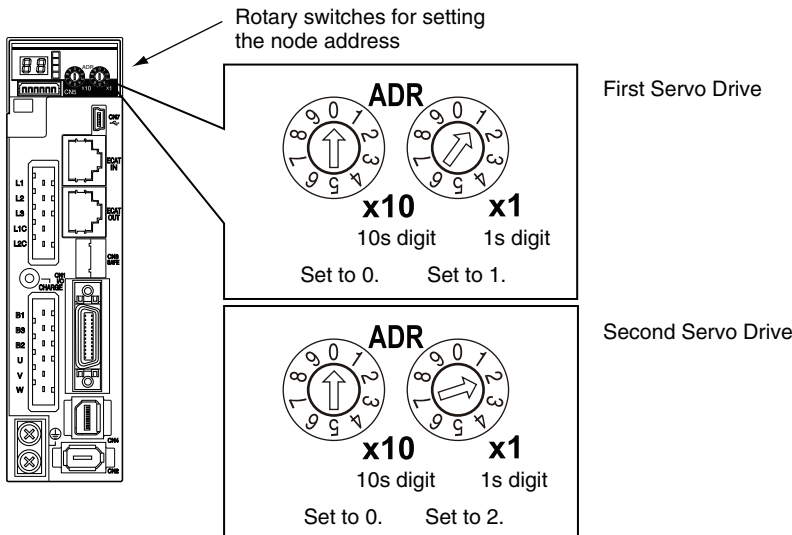

2-2-4 Wiring the Servo Drives and the Servomotors

Wire the Servo Drives and the Servomotors as shown in the following figure.

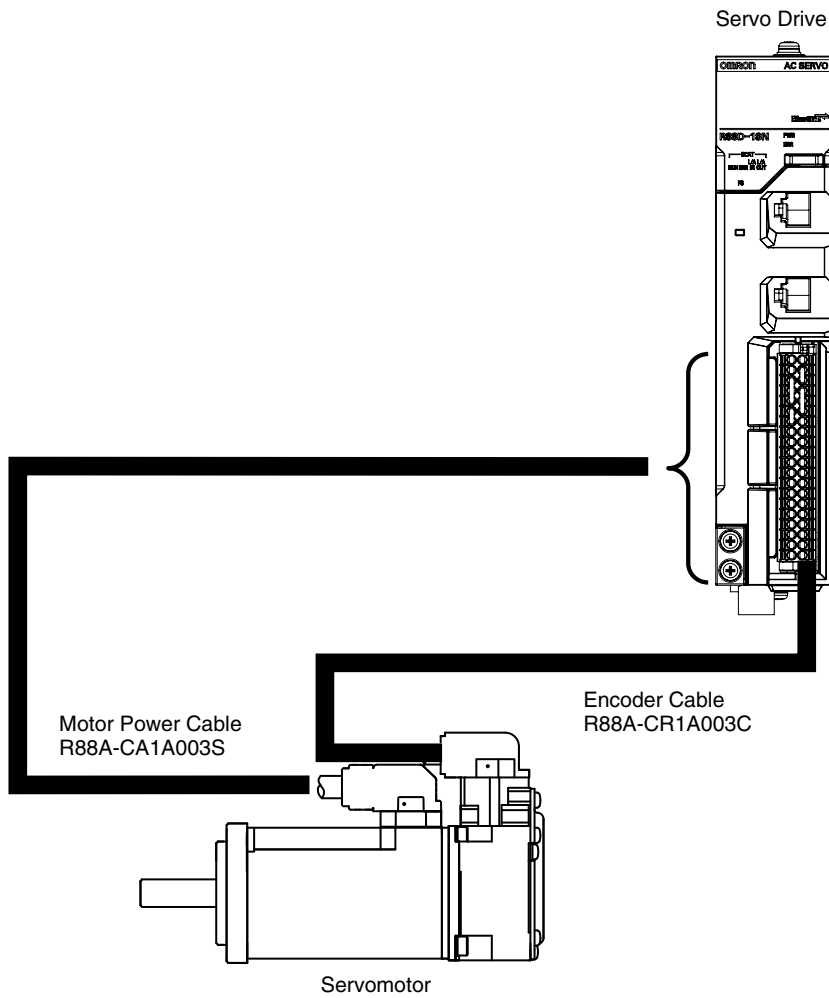

2-2-5 Wiring the Control Input Signals for the Servo Drives

Wire the control input signals for the Servo Drive using the R88A-CN101C Control I/O connector (CN1). For details on wiring, refer to the *AC Servomotors/Servo Drives 1S-series with Built-in EtherCAT Communications User's Manual* (Cat. No. I586).

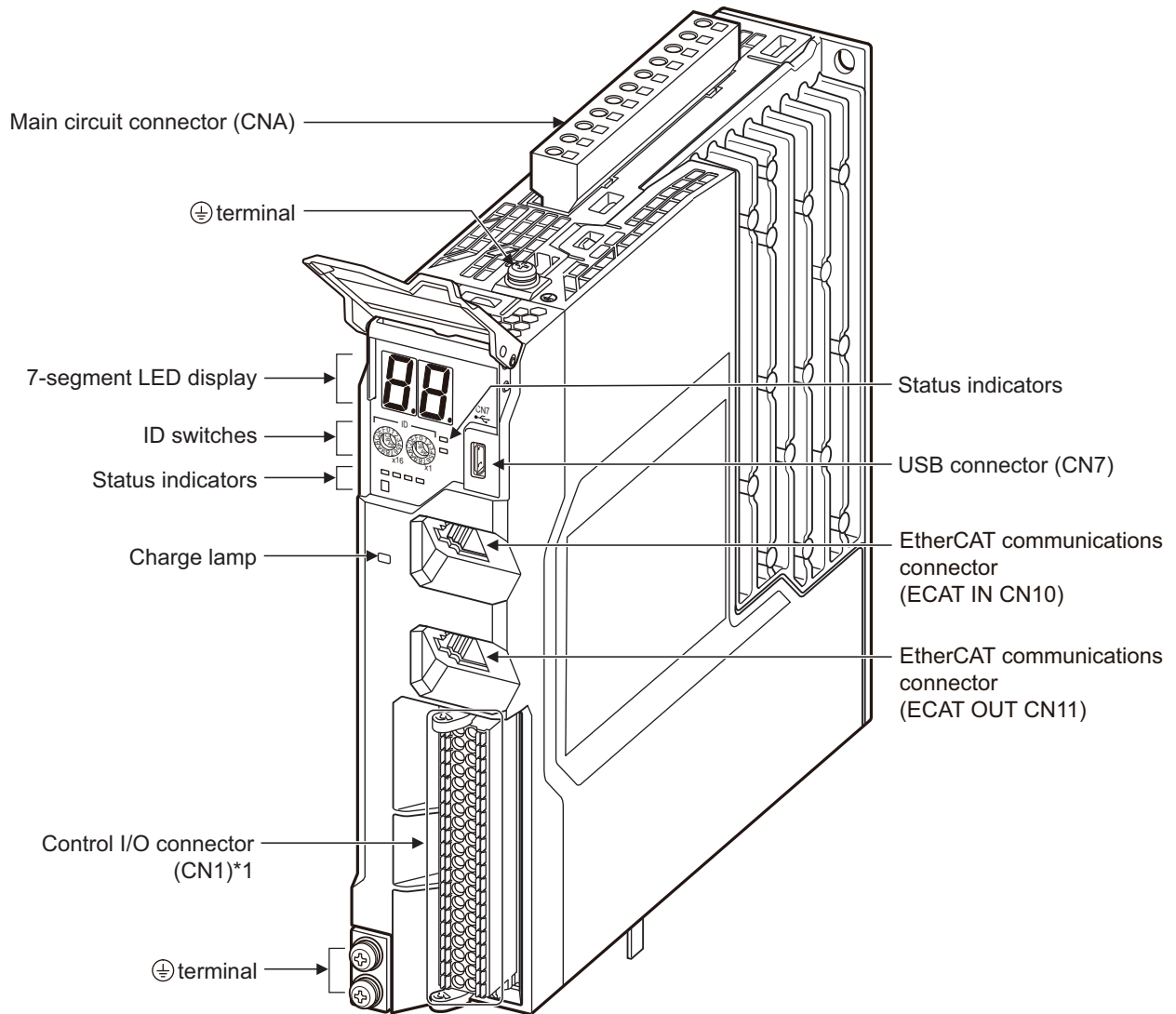

*1 Control I/O Connector (CN1):
Used for command input signals, I/O signals, and as the safety device connector. The short-circuit wire is installed on the safety signals before shipment.



Additional Information

- If you use the default Servo parameters, you must wire the immediate stop input, negative drive prohibit input, and the positive drive prohibit input. If these inputs are not wired, the CPU Unit will remain in the drive prohibit signal and emergency stop signal detected state, and a minor fault level Controller error will occur. The minor fault level Controller errors that will occur are an Immediate Stop Input Error and a Drive Prohibition Input Error. (The event codes are 68220000 and 64E30000.)
- If the above signals are temporarily not wired while commissioning the system, you can temporarily change the Servo parameters to prevent these errors from occurring in the CPU Unit. Refer to *A-1 Settings When Control Input Signals Are Not Wired* for details on the settings that you must change in this case.

3

Setting Up a Single-axis Servo System

This section describes the procedures and operations required to set up a Servo system for one axis.

3-1	Single-axis Servo System Operation	3-2
3-2	System Setup Procedures	3-3
3-3	Creating a Project	3-4
3-4	Creating the EtherCAT Network Configuration	3-7
3-5	Programming	3-9
3-5-1	Setting the Axis	3-9
3-5-2	Creating the Program	3-17
3-5-3	Checking the Program	3-27
3-6	Transferring the Project to the CPU Unit	3-28
3-7	Confirming System Operation	3-32
3-7-1	Checking for Controller Errors	3-32
3-7-2	Resetting the Absolute Encoder from the Sysmac Studio	3-35
3-7-3	Checking the Servo Drive Wiring	3-38
3-7-4	Checking Program Operation	3-44
3-7-5	Using Data Tracing to Check Operation	3-50

3-1 Single-axis Servo System Operation

This section describes the operation of the single-axis Servo system that is set up in this Guide.

Axis 0 performs alternating single-axis positioning in the positive and negative directions.

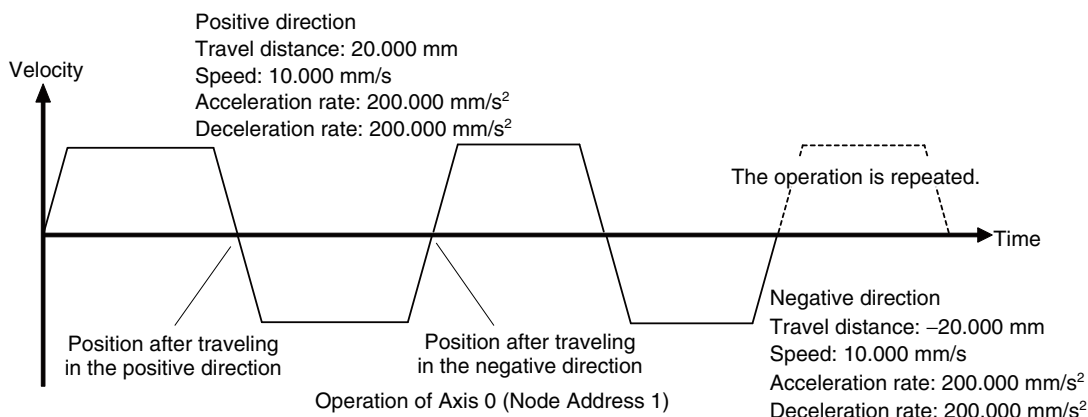

The mechanical configuration of axis 0 is as shown in the following table.

Item	Axis 0 mechanical configuration
Motor rated speed	3,000 r/min
Ball screw pitch	10.000 mm
Encoder resolution	23 bits/rotation

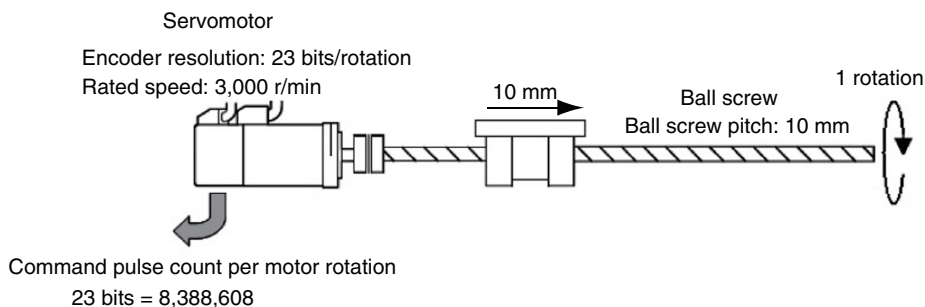

3-2 System Setup Procedures

The basic design flow to follow to design a Servo system is shown below.
The startup operations in this Guide are described in the following steps.

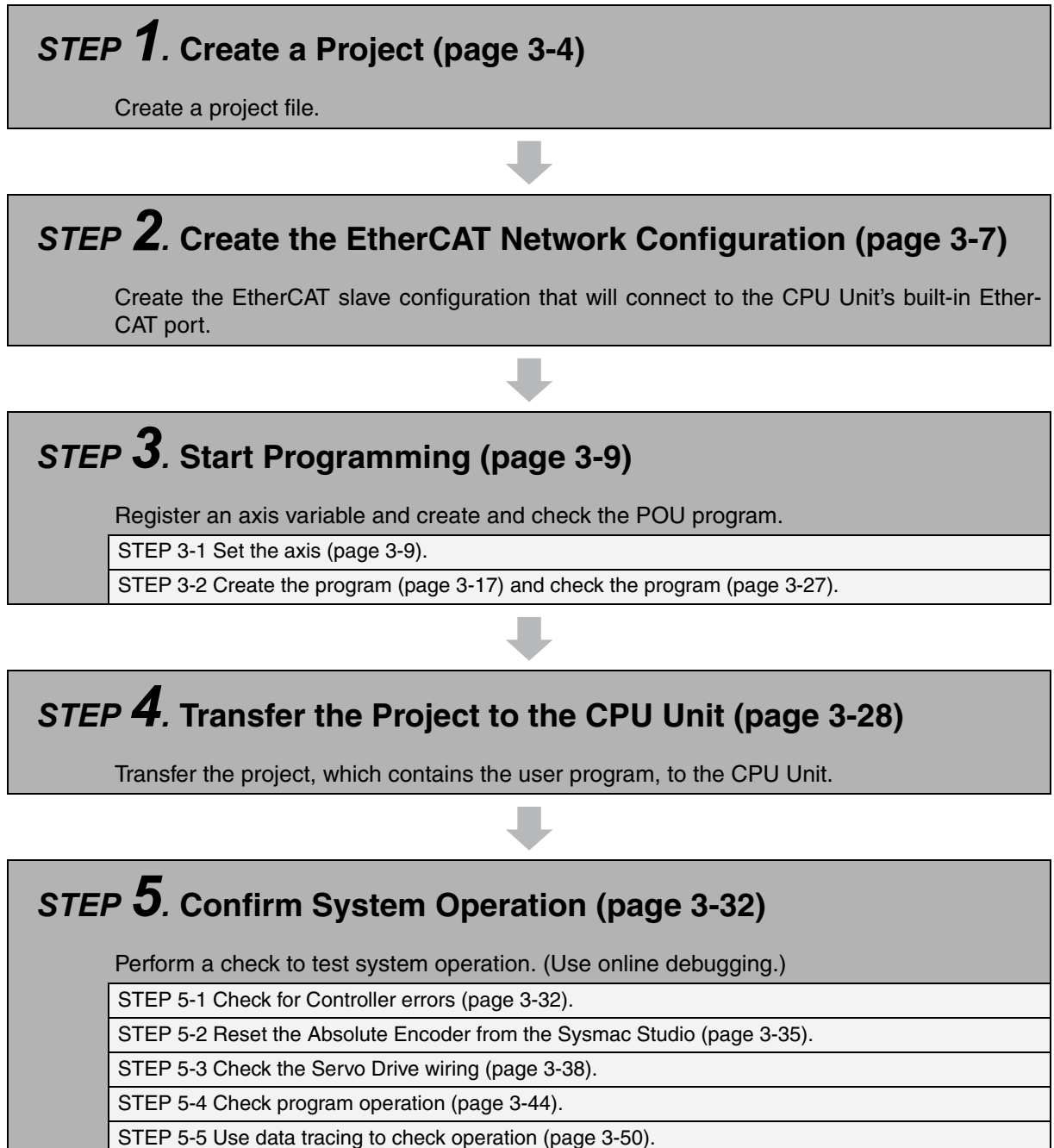

3-3 Creating a Project

Start the Sysmac Studio and create a project.

Starting the Sysmac Studio

Use one of the following methods to start the Sysmac Studio.

- Double-click the Sysmac Studio shortcut icon on your desktop.

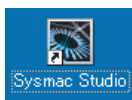

- Select **All Programs – OMRON – Sysmac Studio – Sysmac Studio** from the Windows Start Menu.

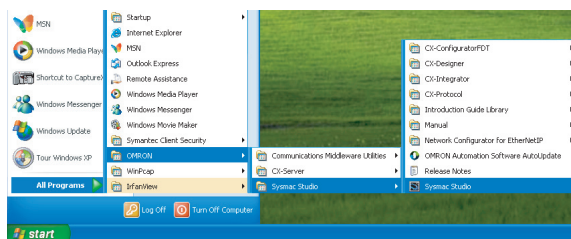

The Sysmac Studio starts and the following window is displayed.



Creating a Project

Create a project in the Sysmac Studio.

- 1 Click the **New Project** Button in the Project Window.

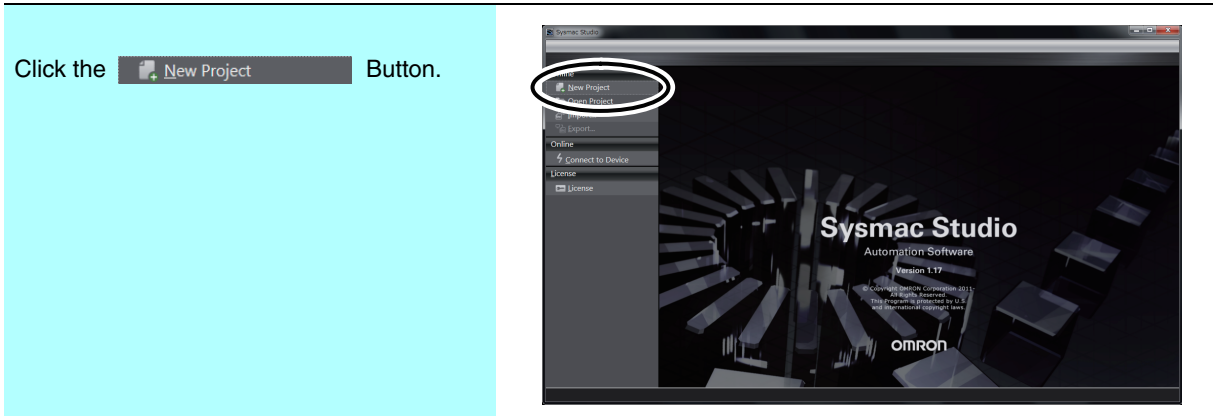

- 2 In the **Project Properties** Dialog Box, select *NXP12-1140DT* in the *Device Box* and the version to use in the *Version Box*, and then click the **Create** Button.

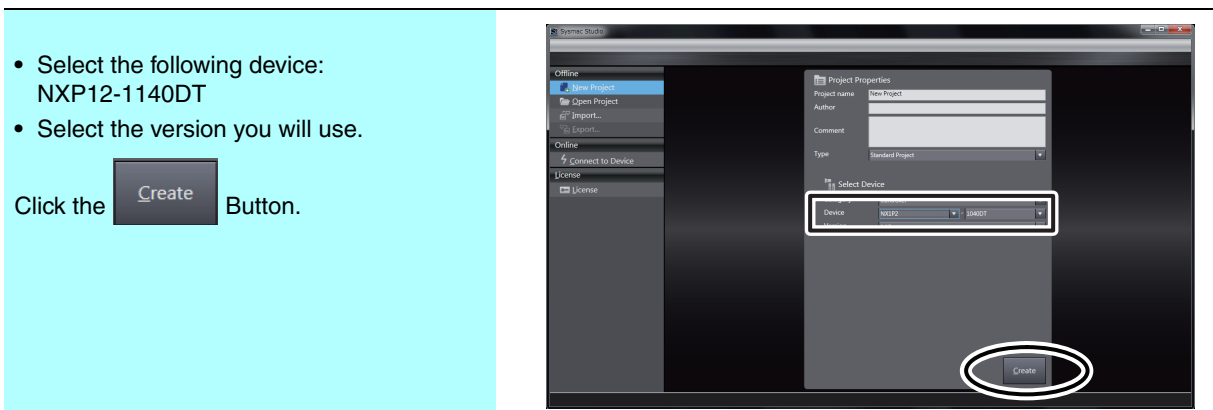

A project file is created and the following window is displayed.

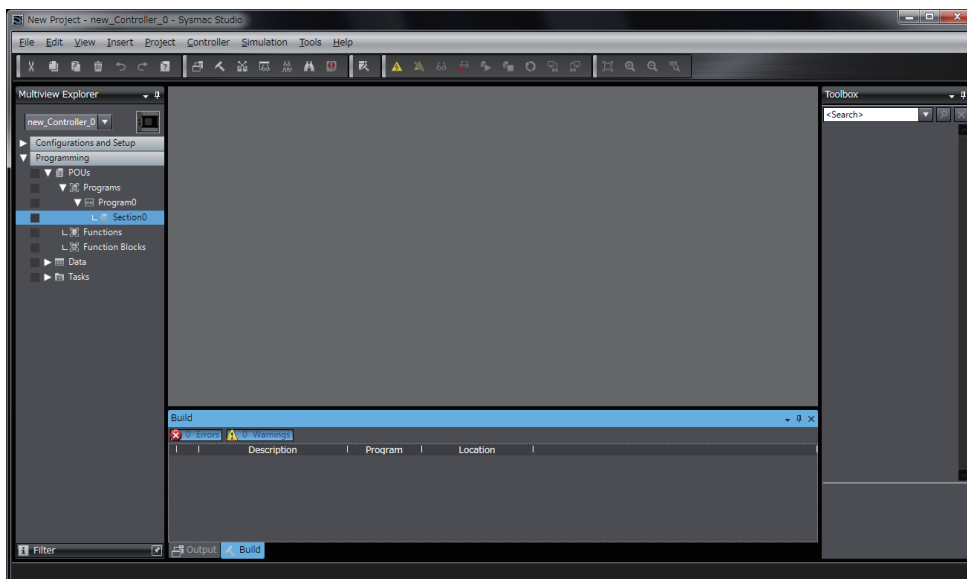

This concludes the procedure to create a project file.

Parts of the Window

This section gives the names and functions of the parts of the Sysmac Studio Window.

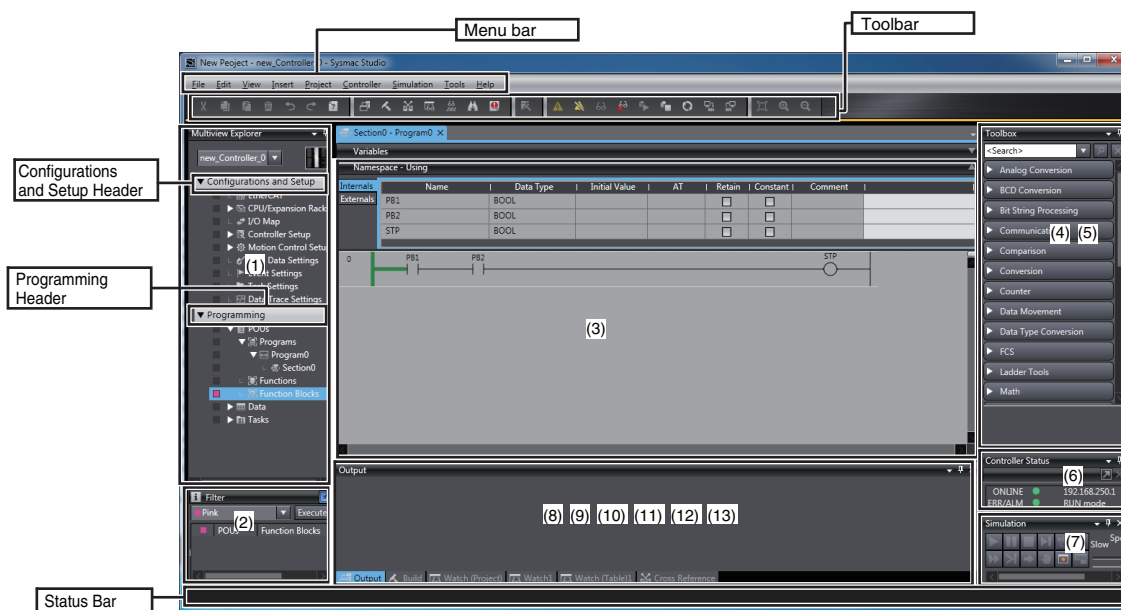

No.	Name	
(1)	Multiview Explorer	This pane is your access point for all Sysmac Studio data. It is separated into <i>Configurations and Setup</i> and <i>Programming</i> Layers.
(2)	Filter Pane	The Filter Pane allows you to search for color codes and for items with an error icon. The results are displayed in a list.
(3)	Edit Pane	The Edit Pane is used to display and edit the data for any of the items. It is separated into <i>Configurations and Setup</i> and <i>Programming</i> Layers.
(4)	Toolbox	The Toolbox shows the objects that you can use to edit the data that is displayed in the Edit Pane.
(5)	Search and Replace Pane	In this pane, you can search for and replace strings in the data in the Programming Layer.
(6)	Controller Status Pane	The Controller Status Pane shows the current operating status of the Controller. The Controller Status Pane is displayed only while the Sysmac Studio is online with the Controller.
(7)	Simulation Pane	The Simulation Pane is used to set up, start, and stop the Simulator for the Controller.
(8)	Cross Reference Tab Page	A Cross Reference Tab Page displays a list of where variables, data types, I/O ports, functions, and function blocks are used in the Sysmac Studio.
(9)	Output Tab Page	The Output Tab Page shows the results of building.
(10)	Watch Tab Page	The Watch Tab Page shows the monitor results of the Simulator or online Controller.
(11)	Build Tab Page	The Build Tab Page shows the results of program checks and building.
(12)	Search and Replace Results Tab Page	The Search and Replace Results Tab Page shows the results when Search All or Replace All is executed.
(13)	Differential Monitor Tab Page	You can detect the number of times the specified BOOL variable or member changes to TRUE or FALSE and display the count in this tab page.

Refer to the *Sysmac Studio Version 1 Operation Manual* (Cat. No. W504) for details on the Sysmac Studio panes and tab pages.

3-4 Creating the EtherCAT Network Configuration

A R88D-1SN01L-ECT Servo Drive is registered in the EtherCAT network configuration to operate as axis 0.

- 1 Double-click **EtherCAT** under **Configurations and Setups** in the Multiview Explorer.



The EtherCAT Tab Page is displayed in the Edit Pane.

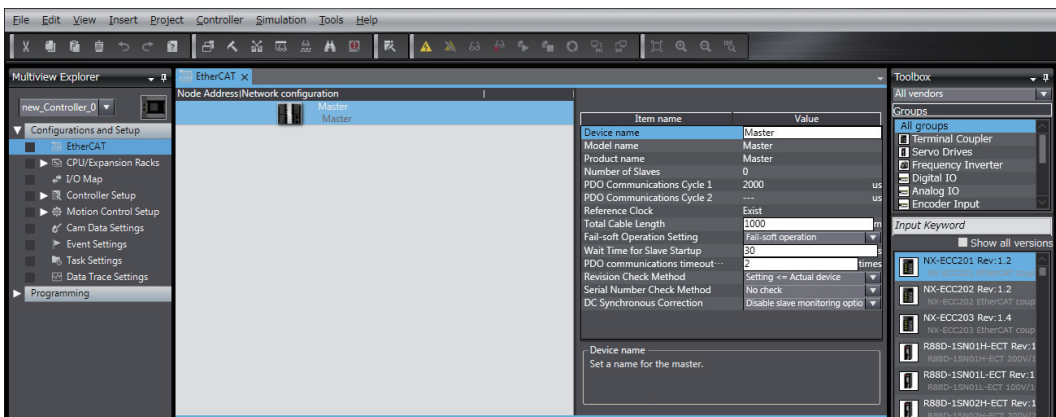

2 Drag the R88D-1SN01L-ECT from the Toolbox to the master on the EtherCAT Tab Page.

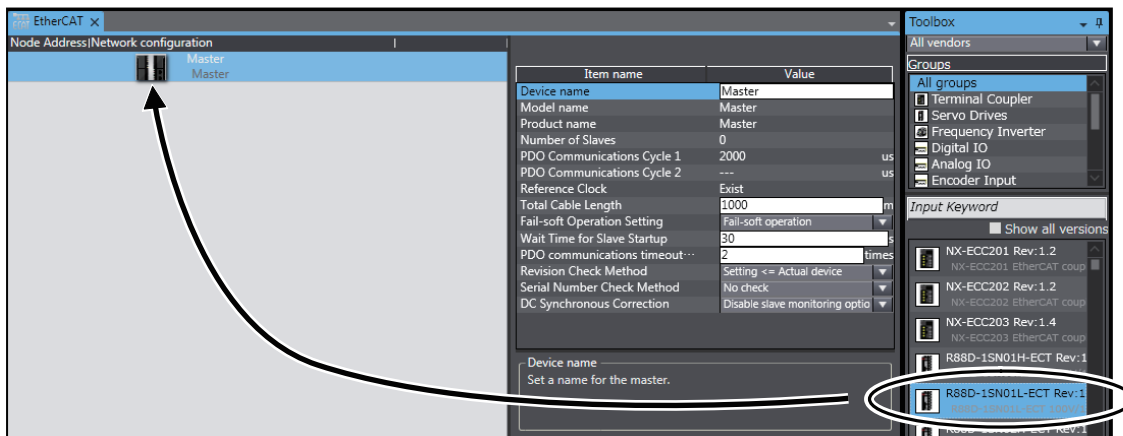

The Servo Drive is added under the master with a node address of 1.

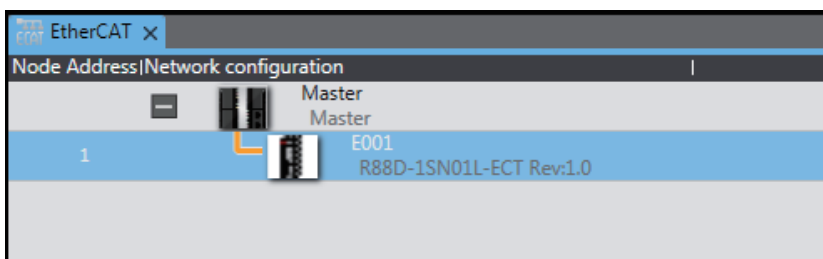

This concludes the creation of the EtherCAT network configuration.



Additional Information

If the physical EtherCAT network configuration is already connected, you can automatically create the virtual network configuration in the Sysmac Studio based on the physical network configuration.

Refer to the *Sysmac Studio Version 1 Operation Manual* (Cat. No. W504) for specific procedures.

3-5 Programming

In this section we will create the user program.

A Servo axis for axis 0 will be added and set up, and a program will be created to control the Servo Drive.

3-5-1 Setting the Axis

This section describes how to add the axis that is used to control the Servo Drive, assign it to the Servo Drive, and set the axis parameters. In this example, the Control Function of the axis to add is set to Single-axis Position Control Axis in order to perform single-axis position control.

Adding the Axis Settings

Add the axis settings for axis 0.

- 1 Right-click **Axis Settings** in the Multiview Explorer and select **Add – Single-axis Position Control Axis** from the menu.

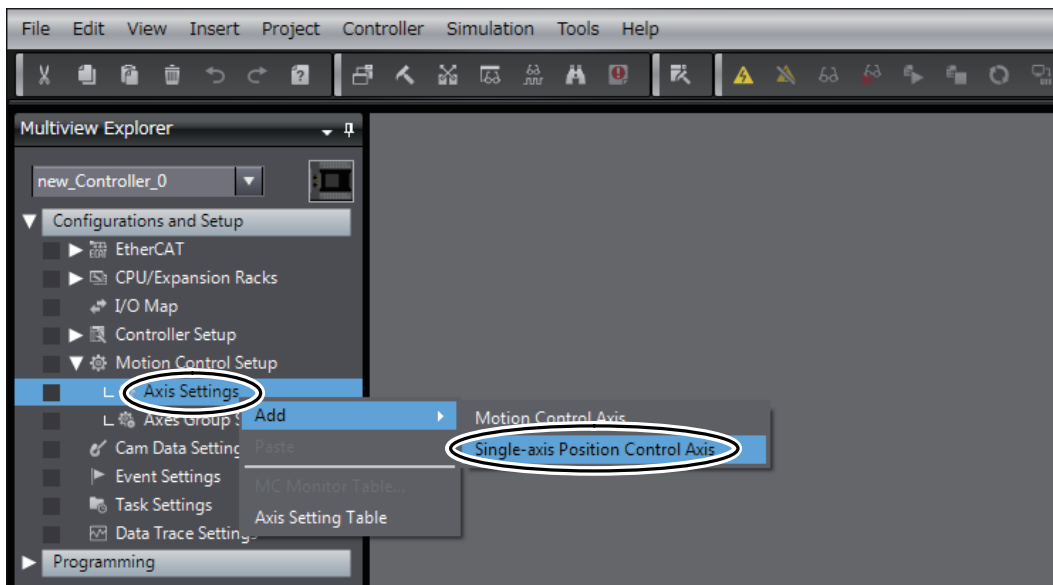

Axis 0 is added to the Multiview Explorer.

The axis is added as *MC_Axis000*. This axis is called axis 0.

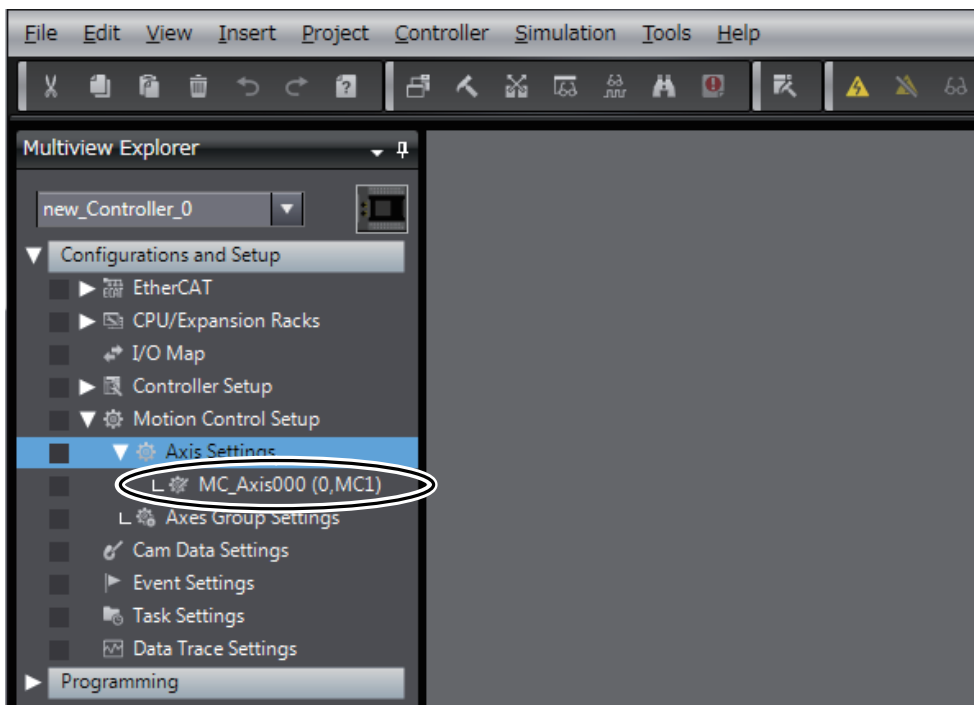

Assigning a Servo Drive to the Axis

Next, assign the Servo Drive in the EtherCAT network configuration to the new axis 0 (*MC_Axis000*).

- 1 Right-click **MC_Axis000** (axis 0) in the Multiview Explorer and select **Edit** from the menu.

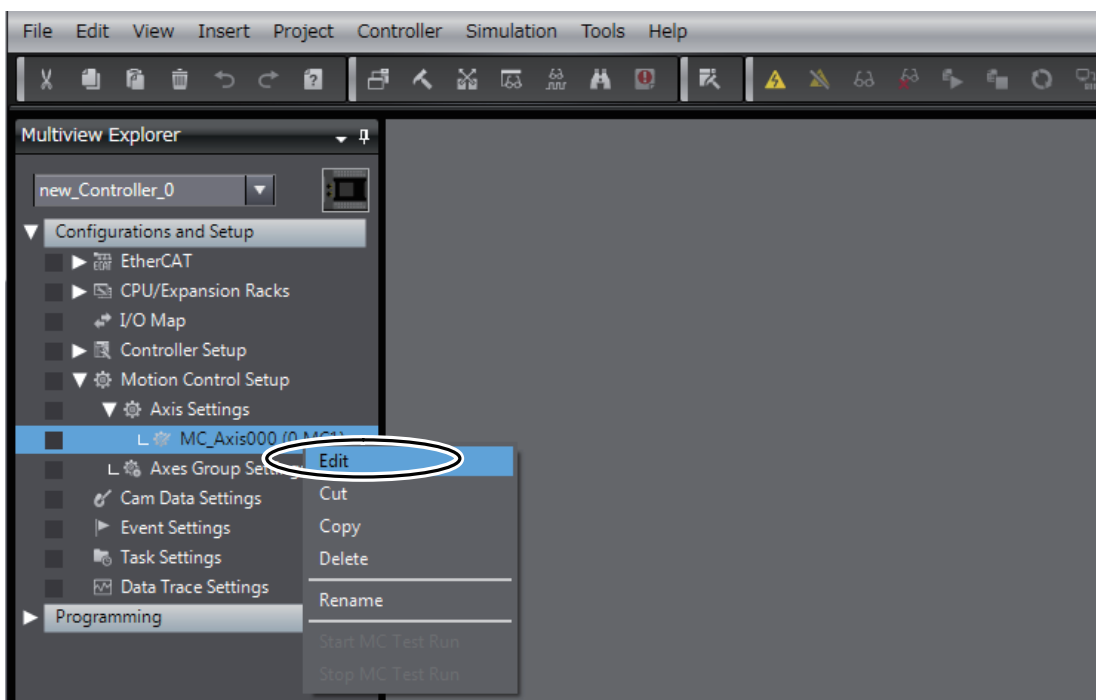

The Axis Basic Settings are displayed on the Axis Parameter Settings Tab Page in the Edit Pane.

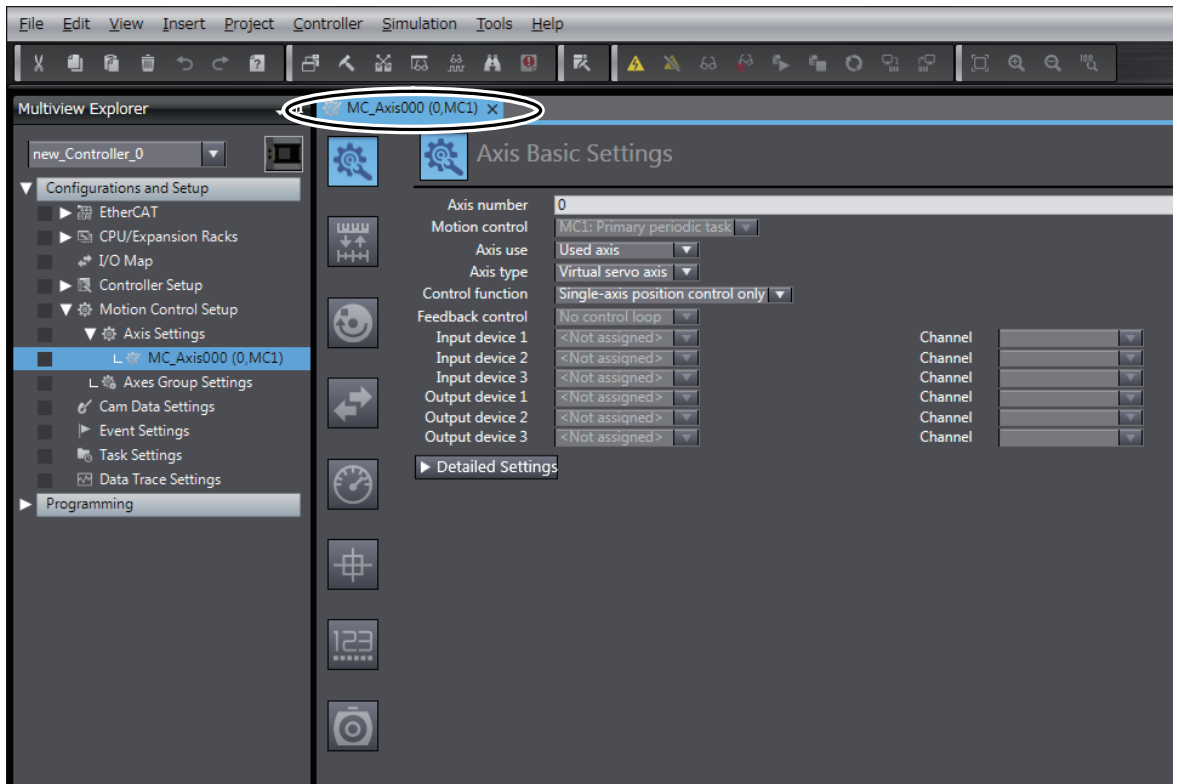

2 Select *Servo axis* in the *Axis type* Box.

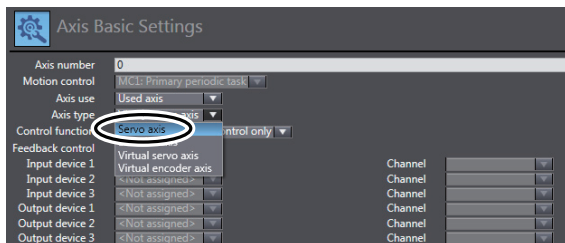

3 Select the Servo Drive to use in the *Output device* Box (Node: 1, Device: R88D-1SN01L-ECT).

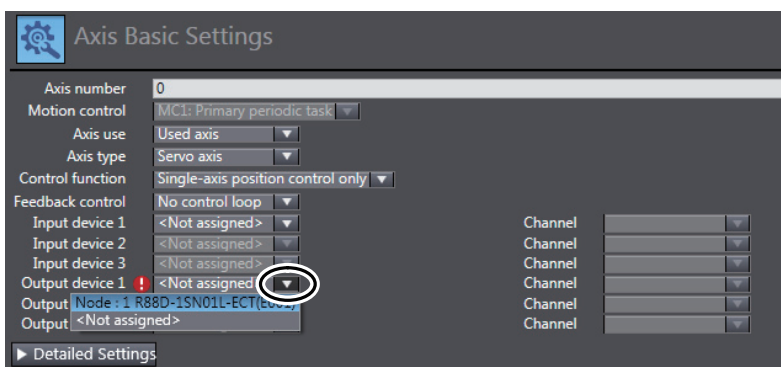

This will assign node 1 and device R88D-1SN01L-ECT as the output device for axis 0.

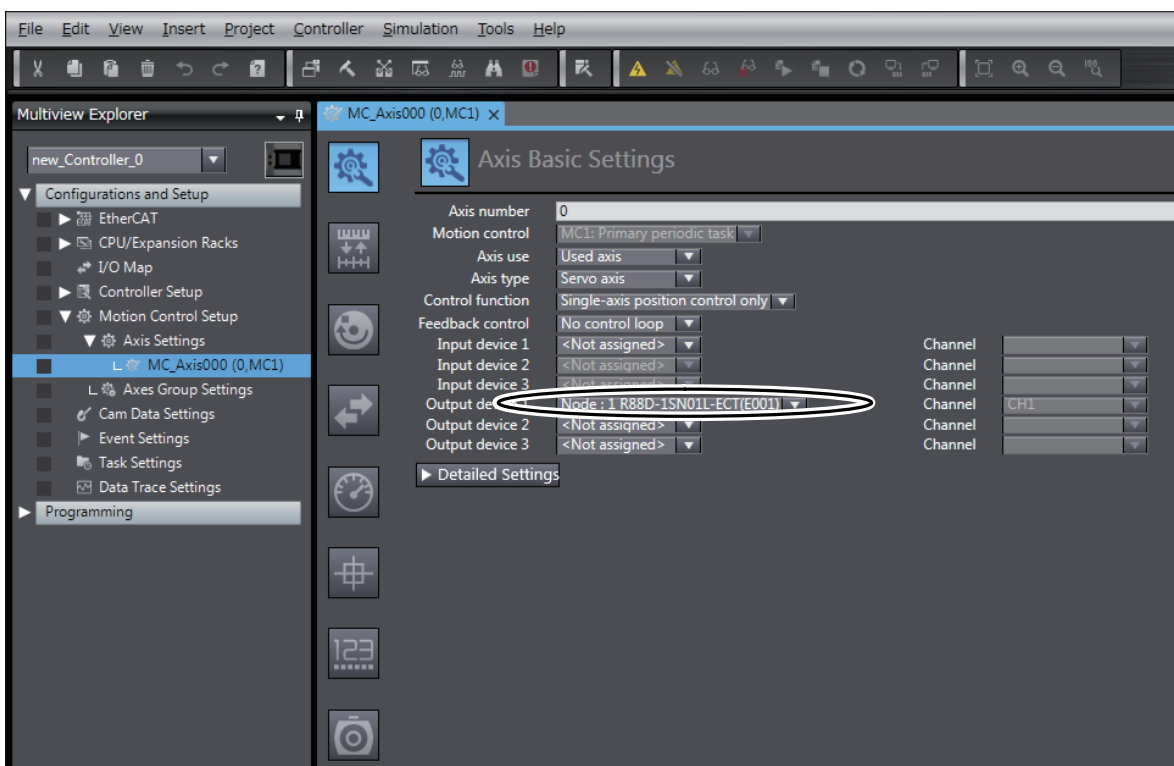



Now, node 1 with device R88D-1SN01L-ECT can be used as an axis in the EtherCAT network configuration.

Setting the Axis Parameters

Set the axis parameters for axis 0 based on the mechanical configuration of the system.

The input axis parameters are shown in the following table according to the mechanical configuration of axis 0.

Icon on Settings Tab Page	Item	Set value	
	Unit Conversion Settings	Unit of Display	mm
		Command Pulse Count Per Motor Rotation	8,388,608
		Work Travel Distance per Motor Rotation	10.000 mm
	Operation Settings	Maximum Velocity	500 mm/s
		Maximum Jog Velocity	50 mm/s
	Position Count Settings	Encoder type	Absolute encoder

1 Set the parameters on the Axis Parameter Settings Tab Page.

Click an icon on the Axis Parameter Settings Tab Page to display the settings for that particular icon.

Set the axis parameters as indicated below.

- Unit Conversion Settings

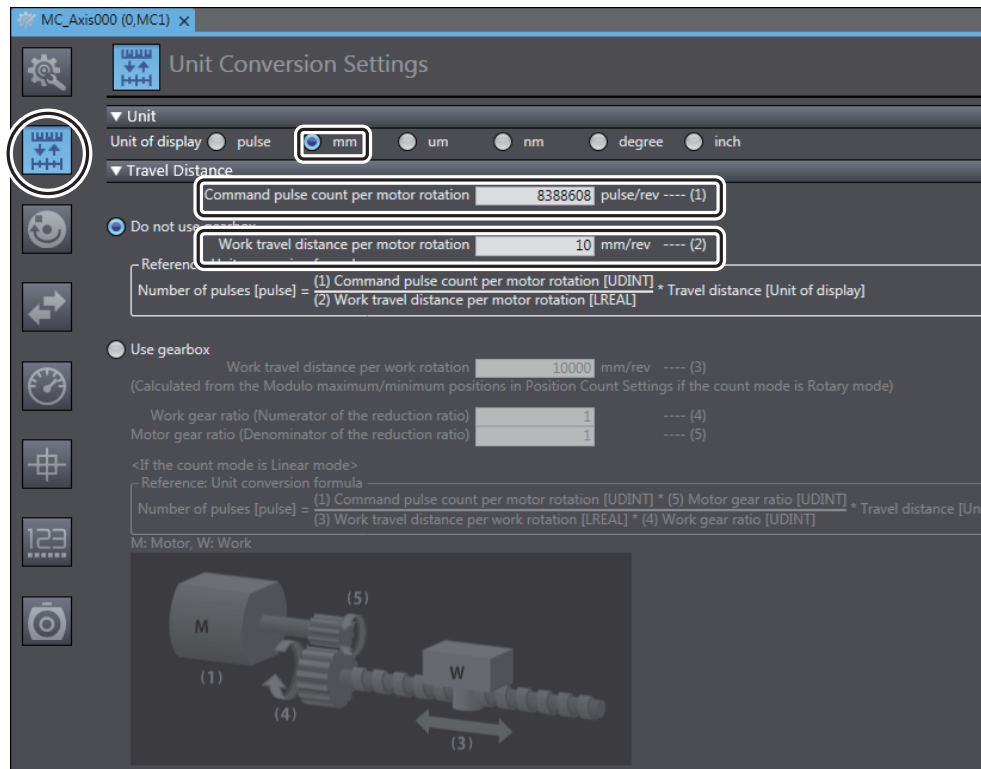

The screenshot shows the 'Unit Conversion Settings' dialog for 'MC_Axis000 (0, MC1)'. The 'Unit' section has 'mm' selected. The 'Travel Distance' section has 'Command pulse count per motor rotation' set to 8388608 pulse/rev and 'Work travel distance per motor rotation' set to 10 mm/rev. The 'Use gearbox' section has 'Work travel distance per work rotation' set to 10000 mm/rev. The gear diagram at the bottom shows a motor (M) connected to a workpiece (W) via a gear train, with labels (1) through (5) corresponding to the parameters in the settings.

- Operation Settings

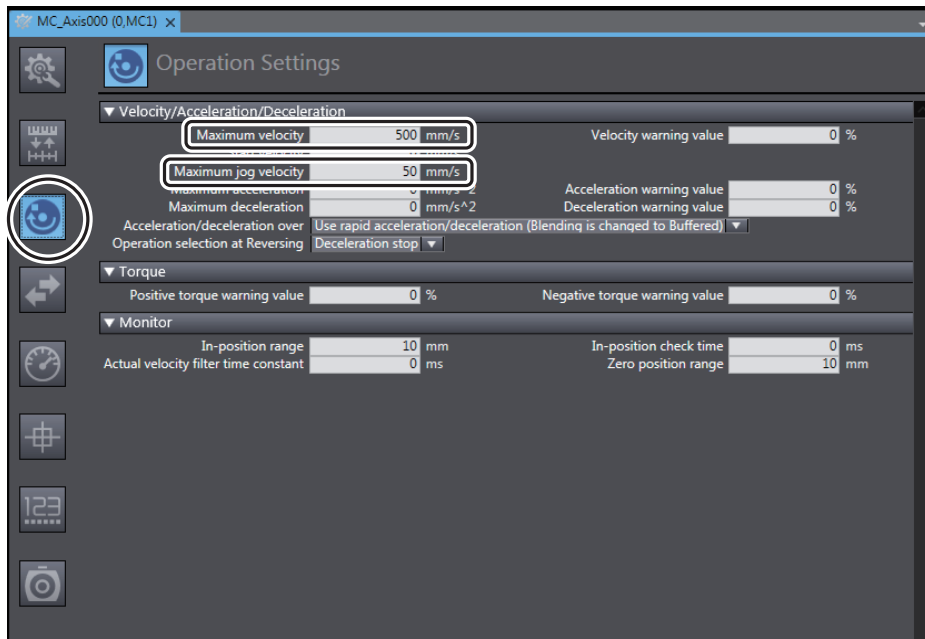

- Position Count Settings

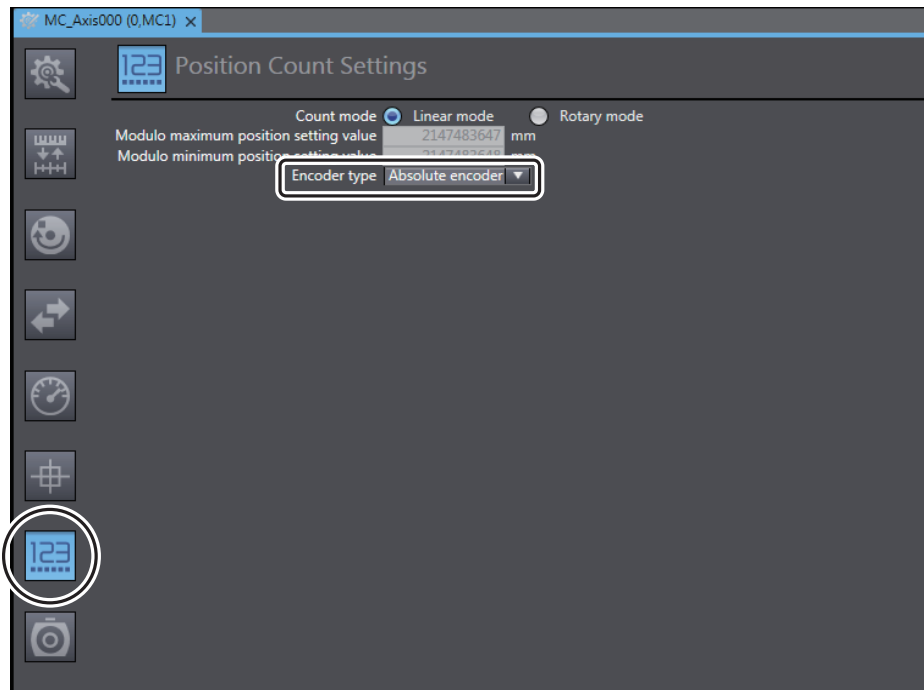



Additional Information

You can also set the parameters for all axes on the same tab page.

Right-click **Axis Settings** in the Multiview Explorer and select **Axis Setting Table** from the menu to display the Axis Setting Table. The Axis Setting Table allows you to set the axis settings and axis parameters for all axes that have been added.

Axis Name	1 MC_Axis000
Axis Basic Settings	
Axis number	0
Motion control	MCI: Primary periodic task
Axis use	Used axis
Axis type	Servo axis
Control function	Single-axis position control only
back control	No control loop
device 1	-
inel	-
device 2	-
Input device 3	-
Channel	-
Output device 1	Node :1
Channel	CHI
Output device 2	-
Channel	-
Output device 3	-
Channel	-
Unit Conversion Settings	
Unit of display	mm
Command pulse count per	8388608 pulse/rev
Gearbox usage	Do not use gearbox
Work travel distance per mo	10 mm/rev
Work travel distance per wo	10000 mm/rev
Work gear ratio (Numerator	1
Motor gear ratio (Denomina	1
Operation Settings	
Maximum velocity	500 mm/s
Velocity warning value	0 %
Start velocity	0 mm/s
Maximum jog velocity	50 mm/s
Maximum acceleration	0 mm/s ²
Acceleration warning value	0 %
Maximum deceleration	0 mm/s ²
Deceleration warning value	0 %

Confirming That the Axis Variable Is Registered

A structure variable that is defined to hold information on an axis, such as physical quantities, status, and error information, is called an axis variable.

The axis variables are used in the user program to specify axes.

When an axis is added, an axis variable for that axis is automatically added to the global variable table.

Use the following method to check the axis variables.

- 1 Right-click **Global Variables** under **Programming - Data** in the Multiview Explorer and select **Edit** from the menu.



The global variable table is displayed in the Edit Pane.

You can confirm that the *MC_Axis000* axis variable for axis 0 has been added automatically.

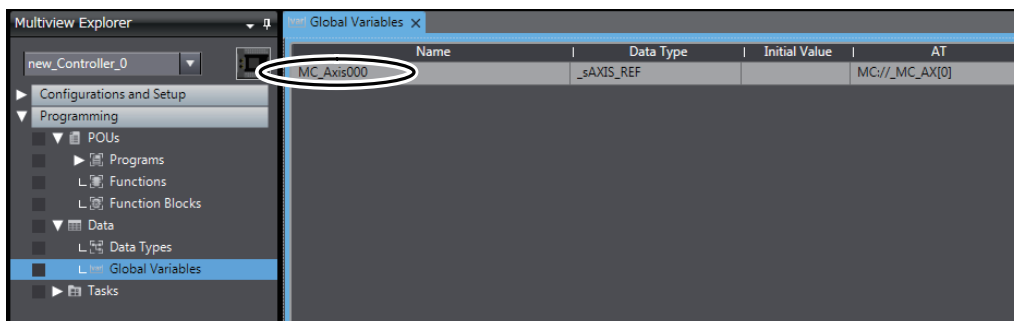

3-5-2 Creating the Program

Create the instructions that control the Servo Drive in section 0 of program 0. Program 0 is automatically created when you create a project.

The following instructions are created. To do so, we will use an axis variable and motion control instructions.

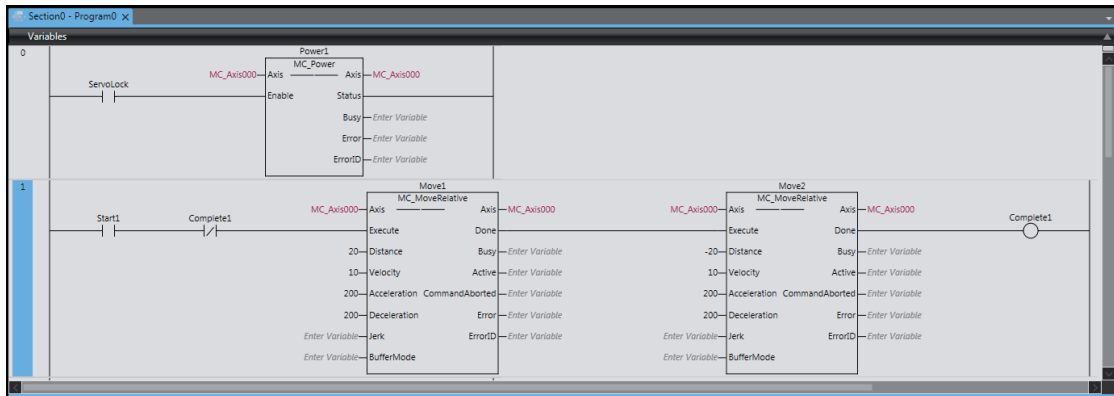

Refer to the *NJ/NX-series Startup Guide for CPU Units* (Cat. No. W513) for details on how to create ladder diagrams.



Precautions for Correct Use

The sample programming that is provided in this Guide includes only the programming that is required to operate the Servomotors. When programming actual applications, also program EtherCAT communications, device interlocks, I/O with other devices, and other control procedures.

Opening the Ladder Editor

To enter the program, you must start the Ladder Editor and open section 0 of program 0.

- 1 Right-click **Section0** under **Programming – POU – Programs – Program0** in the Multiview Explorer, and select **Edit** from the menu.

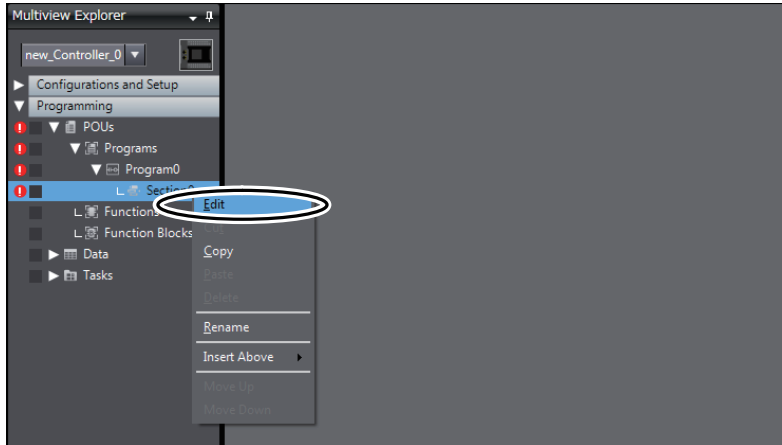

The local variable table and Ladder Editor are displayed in the Edit Pane. From here, you can register local variables and create a ladder diagram.

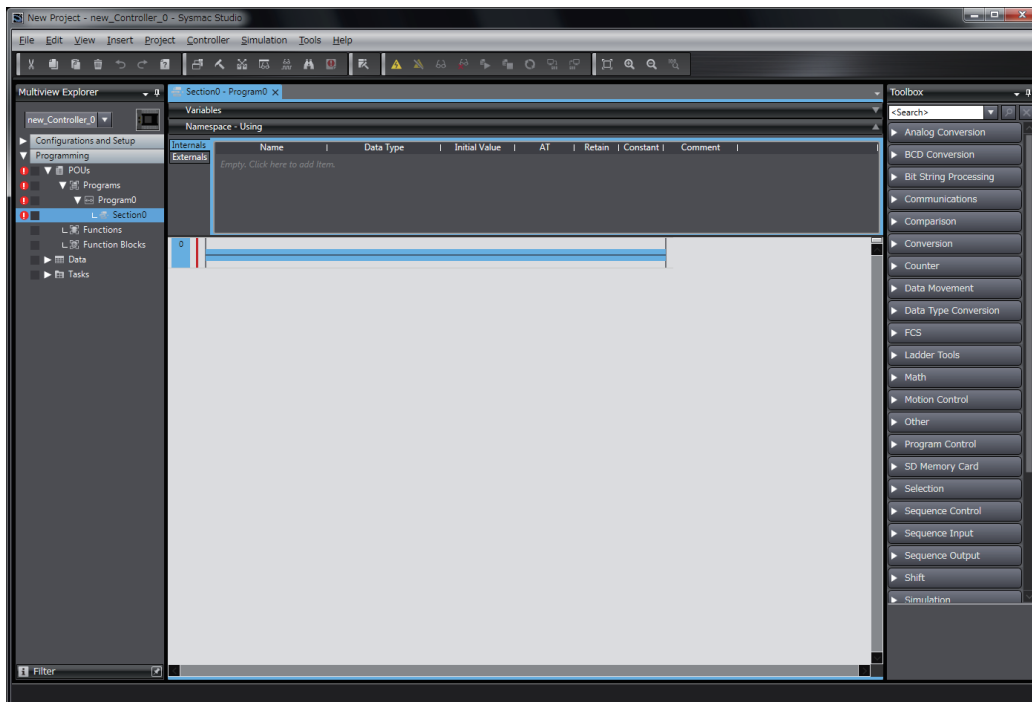

Creating the Instructions That Turn the Servo ON and OFF

You must turn ON the Servo in order to execute single-axis positioning from the Servo Drive. The `MC_Power` (Power Servo) instruction is used to control turning the Servo ON and OFF.

- 1 Enter an input for the `ServoLock` variable to control turning the Servo ON and OFF.

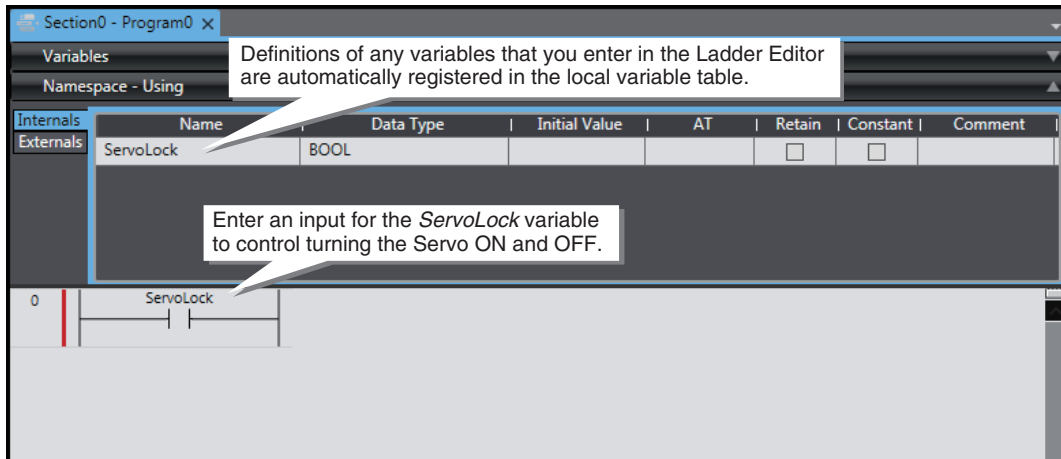

- How to enter an NO input
Right-click the horizontal line in the Ladder Editor and select **Insert Input** from the menu. Or, press the **C** Key.
- How to display external variables and internal variables
Select **Variable Table** from the View menu.

- 2 Drag `MC_Power` from the **Motion** Area of the Toolbox to the right side of the `ServoLock` input.

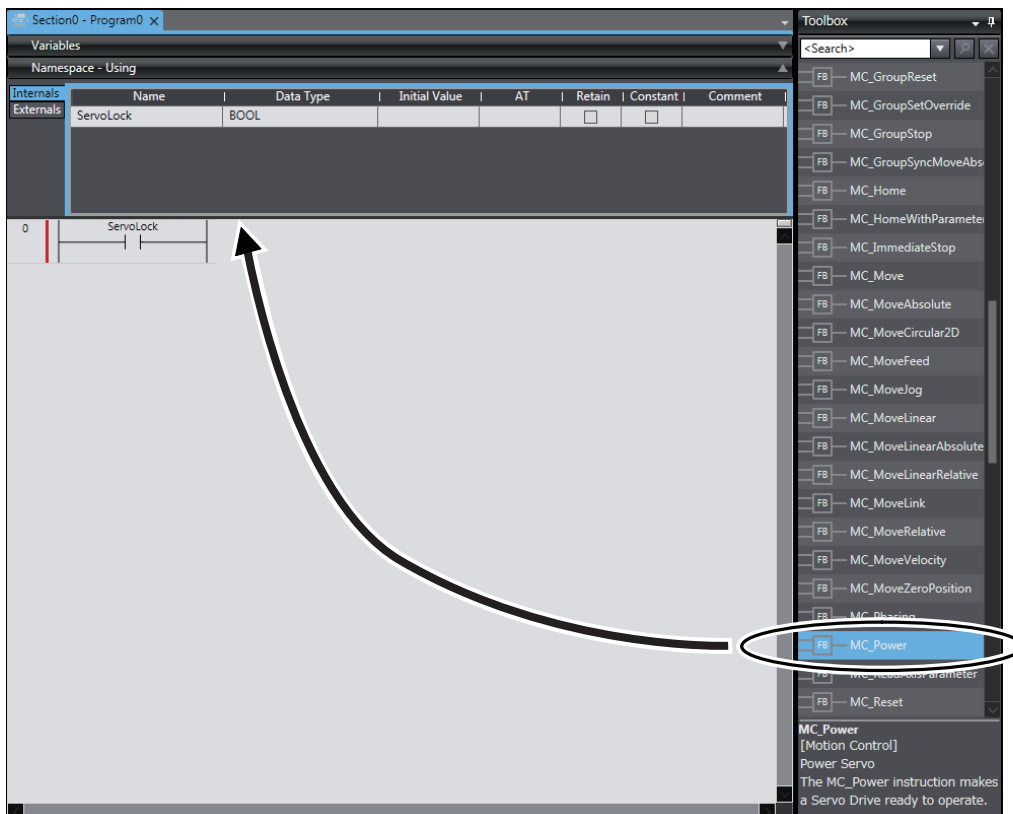

3 Setting Up a Single-axis Servo System

An MC_Power instruction is inserted to the right of the *ServoLock* input.

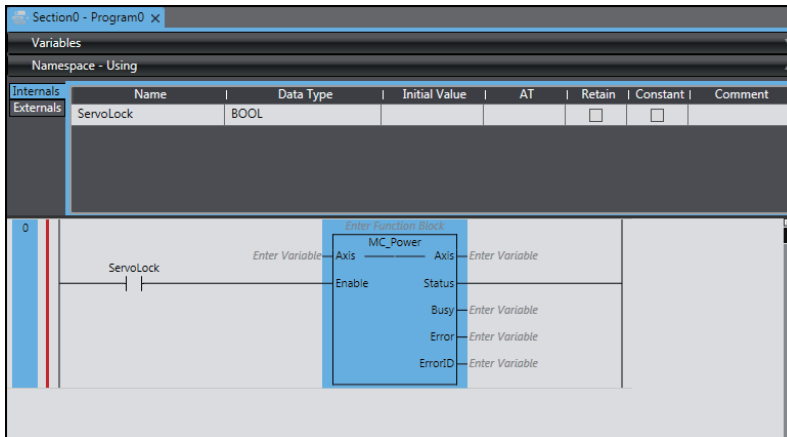

3 Enter *Power1* as the instance name for the MC_Power instruction.

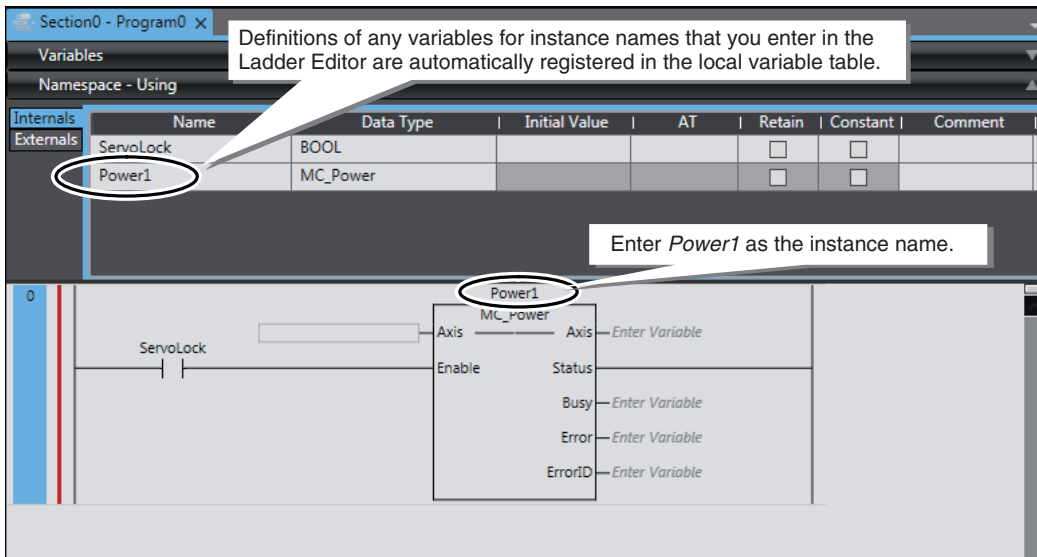

4 Enter the in-out variable for the Power1 instance.

Specify the axis variable of the axis to control for the *Axis* in-out variable of the Power1 instance. The axis variable for axis 0 is *MC_Axis000*.

The screenshot shows a software interface with a 'Variables' table and a ladder logic diagram. The table lists 'ServoLock' as a BOOL variable and 'Power1' as an MC_Power variable. The ladder logic diagram shows a network with a 'ServoLock' normally open contact and a 'Power1' coil. The 'Power1' coil has an 'Axis' input field containing 'MC_Axis000' and an 'Output' field also containing 'MC_Axis000'. Callouts explain that 'MC_Axis000' is the axis variable for axis 0 and that the variable automatically appears on the output side when entered on the input side.

Name	Data Type	Initial Value	AT	Retain	Constant	Comment
ServoLock	BOOL			<input type="checkbox"/>	<input type="checkbox"/>	
Power1	MC_Power			<input type="checkbox"/>	<input type="checkbox"/>	

This concludes the creation of the instructions to control turning the Servo ON and OFF.

Creating the Instructions That Perform Single-axis Positioning

Here, the MC_MoveRelative (Relative Positioning) instruction is used to perform single-axis control. We will use two instances of this instruction to repeatedly perform round-trip operation with single-axis positioning.

- 1 Enter an input for the *Start1* variable to control the Relative Positioning instruction.
To add a rung, select the left bus bar and press the **R** Key.

The screenshot shows the Ladder Editor interface. At the top, a table lists variables defined in the project:

Internals	Name	Data Type	Initial Value	AT	Retain	Constant	Comment
Externals	ServoLock	BOOL			<input type="checkbox"/>	<input type="checkbox"/>	
	Power1	MC_Power			<input type="checkbox"/>	<input type="checkbox"/>	
	Start1	BOOL			<input type="checkbox"/>	<input type="checkbox"/>	

The variable **Start1** is circled in red. Below the table, a callout box states: "Definitions of any variables that you enter in the Ladder Editor are automatically registered in the local variable table." In the ladder editor, a new rung (rung 1) has been added to the left bus bar, containing a normally open contact labeled **Start1**. Another callout box points to this contact: "Enter an input for the *Start1* variable to control the Relative Positioning instruction."

- 2 Enter an NC input for the *Complete1* variable to control the repeated single-axis positioning.
To enter an NC input, select the horizontal line in the Ladder Editor and press the **/** Key.

The screenshot shows the Ladder Editor interface after adding a second variable. The variable table is updated:

Internals	Name	Data Type	Initial Value	AT	Retain	Constant	Comment
Externals	ServoLock	BOOL			<input type="checkbox"/>	<input type="checkbox"/>	
	Power1	MC_Power			<input type="checkbox"/>	<input type="checkbox"/>	
	Start1	BOOL			<input type="checkbox"/>	<input type="checkbox"/>	
	Complete1	BOOL			<input type="checkbox"/>	<input type="checkbox"/>	

The variable **Complete1** is circled in red. A callout box states: "Definitions of any variables that you enter in the Ladder Editor are automatically registered in the local variable table." In the ladder editor, a second rung (rung 1) is shown. It contains a normally open contact labeled **Start1** followed by a normally closed contact labeled **Complete1**. A callout box points to the **Complete1** contact: "Enter an NC input for the *Complete1* variable, which is turned ON when the round-trip operation is completed."

3 Insert an MC_MoveRelative (Relative Positioning) instruction.

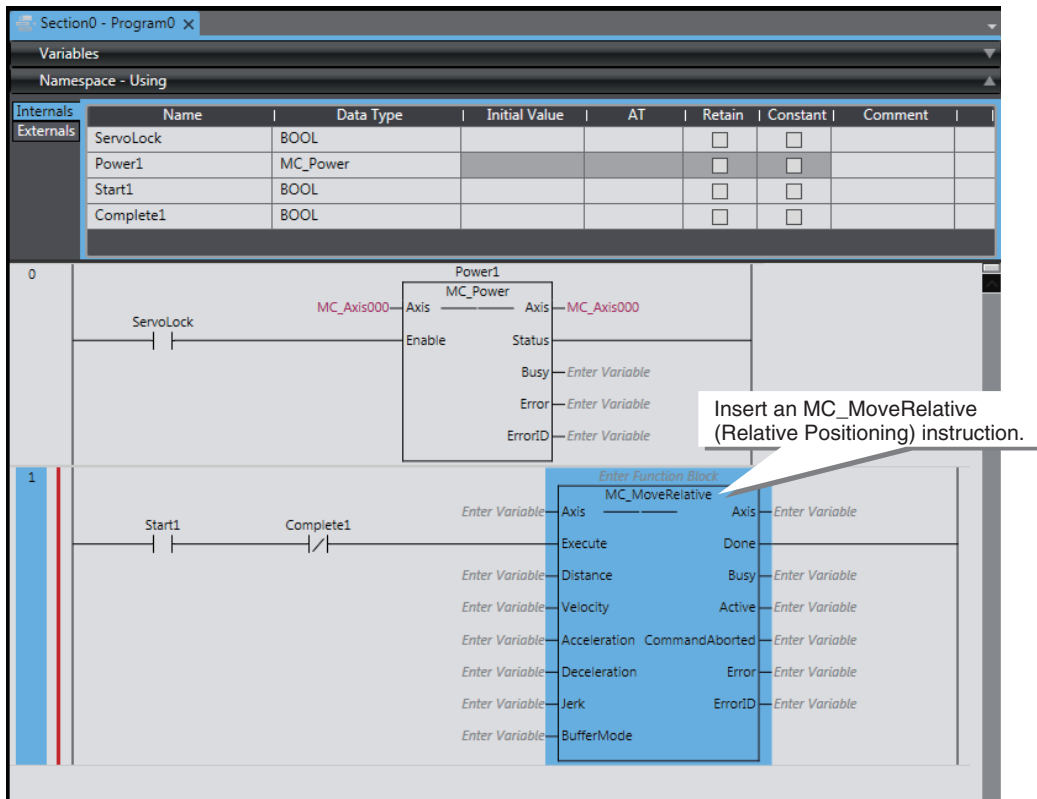

4 Enter *Move1* as the instance name for the MC_MoveRelative instruction.

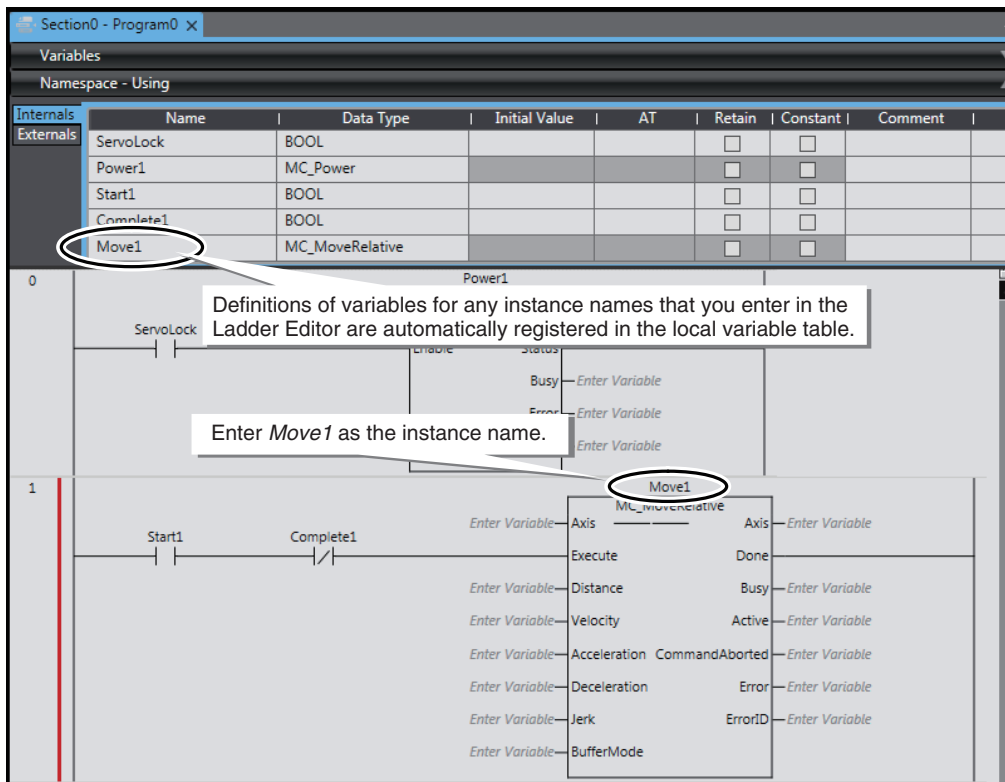

5 Enter the in-out variable for the Move1 instance.

Specify the axis variable of the axis to control for the *Axis* in-out variable of the Move1 instance. The axis variable for axis 0 is *MC_Axis000*.

Internals	Name	Data Type	Initial Value	AT	Retain	Constant	Comment
Externals	ServoLock	BOOL			<input type="checkbox"/>	<input type="checkbox"/>	
	Power1	MC_Power			<input type="checkbox"/>	<input type="checkbox"/>	
	Start1	BOOL			<input type="checkbox"/>	<input type="checkbox"/>	
	Complete1	BOOL			<input type="checkbox"/>	<input type="checkbox"/>	
	Move1	MC_MoveRelative			<input type="checkbox"/>	<input type="checkbox"/>	

The diagram shows a ladder logic network with two rungs. Rung 0 contains a ServoLock input and a Power1 block. Rung 1 contains Start1 and Complete1 inputs and a Move1 block. The Move1 block has an 'Axis' input set to 'MC_Axis000' and an 'Axis' output set to 'MC_Axis000'. Callouts indicate that 'MC_Axis000' is entered on both sides of the Move1 block.

6 Enter the values given in the following table for the input variables of the MC_MoveRelative instruction.

Input variable	Meaning	Set value
Distance	Travel Distance (mm)	20
Velocity	Target Velocity (mm/s)	10
Acceleration	Acceleration Rate (mm/s ²)	200
Deceleration	Deceleration Rate (mm/s ²)	200

The screenshot shows a software interface for configuring a PLC program. At the top, a window titled 'Section0 - Program0 x' displays a 'Variables' table for the 'Namespace - Using'. The table lists several variables: ServoLock (BOOL), Power1 (MC_Power), Start1 (BOOL), Complete1 (BOOL), and Move1 (MC_MoveRelative). Below the table, the main workspace shows two ladder logic rungs. Rung 0 contains a normally open contact labeled 'ServoLock' leading to an 'MC_Power' instruction block. Rung 1 contains two normally open contacts, 'Start1' and 'Complete1', leading to an 'MC_MoveRelative' instruction block. A callout box with the text 'Set the values of the input variables.' points to the input fields of the 'MC_MoveRelative' instruction, where the values 20, 10, 200, and 200 are entered for Distance, Velocity, Acceleration, and Deceleration respectively. The 'Enter Variable' fields for Jerk and BufferMode are also visible.

7 Insert the second MC_MoveRelative (Relative Positioning) instruction.

Enter *Move2* as the instance name, enter the axis variable of axis 0 (*MC_Axis000*) for the in-out variable, and enter the values in the following table for the input variables.

Input variable	Meaning	Set value
Distance	Travel Distance (mm)	-20
Velocity	Target Velocity (mm/s)	10
Acceleration	Acceleration Rate (mm/s ²)	200
Deceleration	Deceleration Rate (mm/s ²)	200

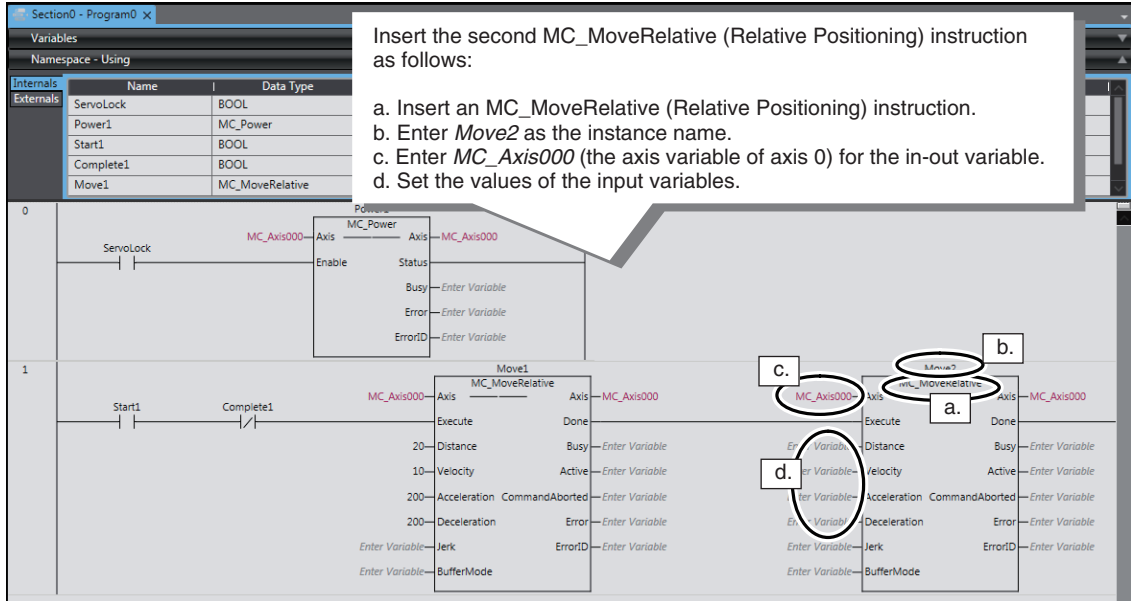

Additional Information

Cascade connections are possible for Ladder Diagram Instructions (e.g., LD (Load) and AND (AND)), for FB instructions (e.g., MC_MoveRelative (Relative Positioning)), and for FUN instructions (e.g., MOVE (Move)). In this program, the Move2 instance is started after relative positioning for the Move1 instance is completed.

8 Enter an output for the *Complete1* variable to turn ON when the round-trip operation is completed.

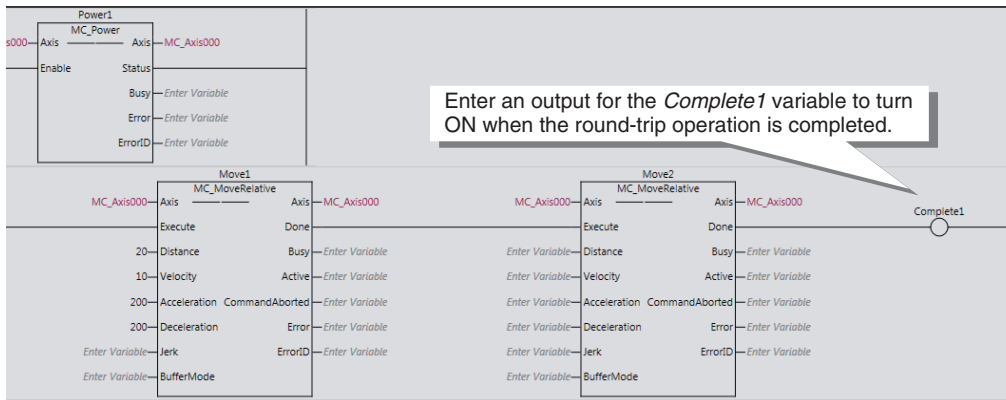

This concludes the creation of the instructions to repeatedly execute single-axis positioning.

3-5-3 Checking the Program

Check the program that you created.

- 1 Select **Check All Programs** from the Project Menu.

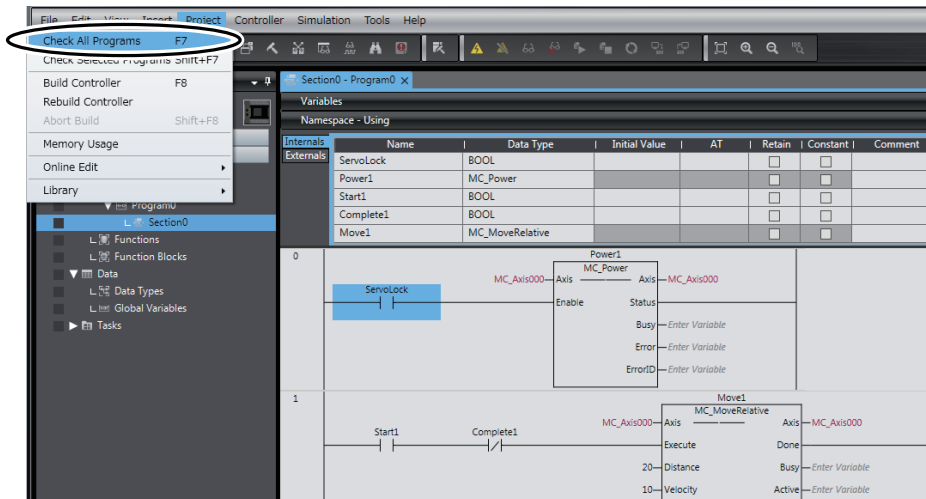

The results of the program check are displayed on the Build Tab Page.

If there are any errors, correct them.

Warnings such as "A parameter is not entered for the output." may be displayed because variables and actual inputs are not assigned in the I/O map. In this case, ignore the warnings and continue the procedure.

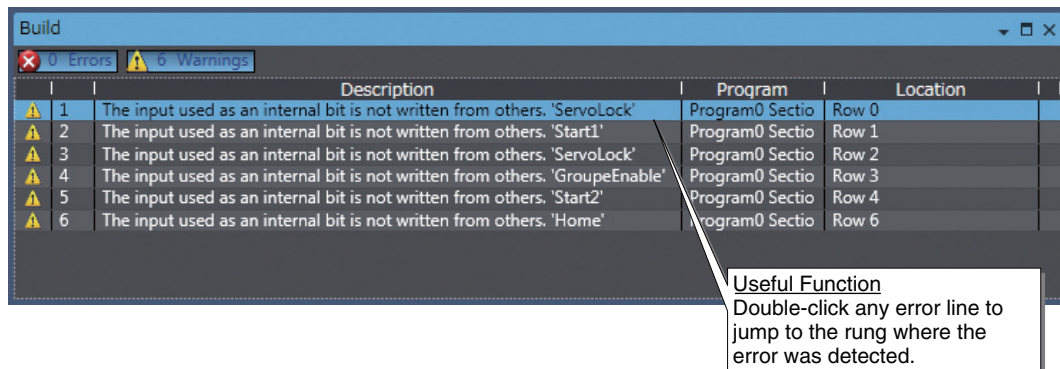

3-6 Transferring the Project to the CPU Unit

The project, which contains the user program, is transferred to the CPU Unit.
Turn ON the power supply to the Controller and to the Servo Drive.

● Online Connection

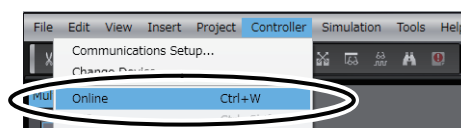

1 Use one of the following methods to go online.

Method 1: Select **Online** from the Controller Menu.



Method 2: Click the  Button on the Toolbar.



Method 3: Press the  **Ctrl +**  **W** Keys.

The CPU Unit name is written to the Controller, and the Sysmac Studio goes online with the Controller.

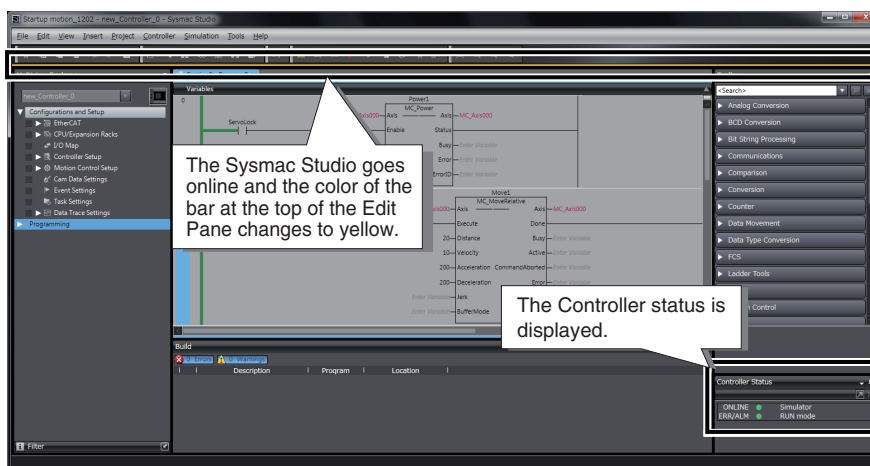



● Transferring the Project

You must transfer the project to the CPU Unit. The synchronize operation is used to transfer the project. Here, “synchronize” means to automatically compare the data for the Sysmac Studio on the computer with the data in the physical Controller and transfer the data in the direction that is specified by the user.

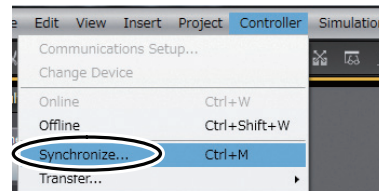

1 Use one of the following methods to display the Synchronize Pane.

Method 1: Select **Synchronize** from the Controller Menu.



Method 2: Click the  Button on the Toolbar.



Method 3: Press the  **Ctrl +**  **M** Keys.

Comparison of the data on the computer and the data in the physical Controller is started. The comparison results are displayed after the comparison is completed.

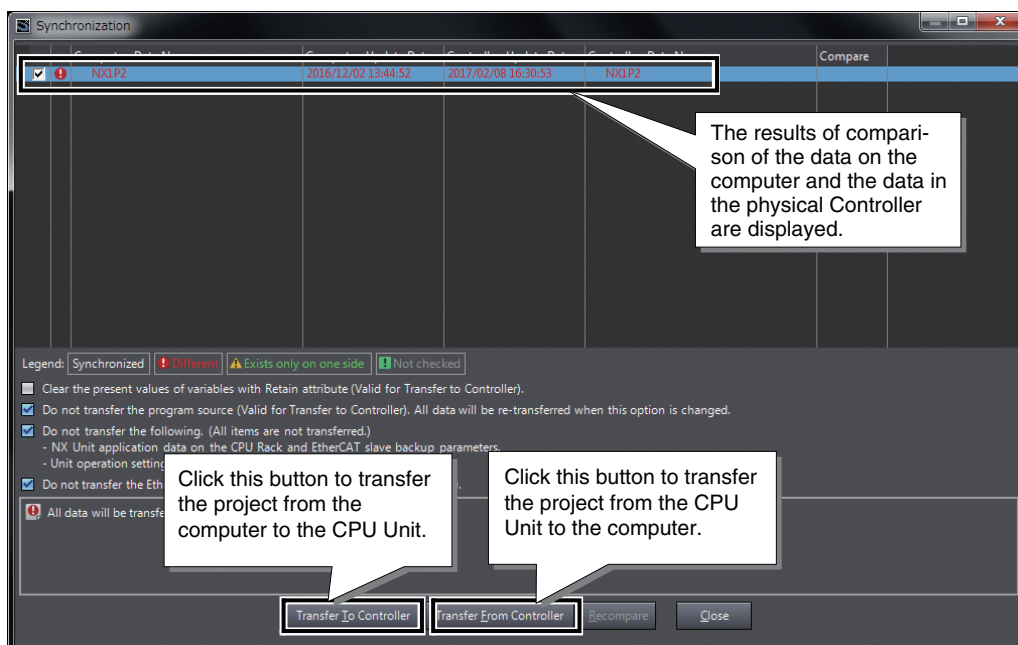

2 Click the **Transfer to Controller** Button.

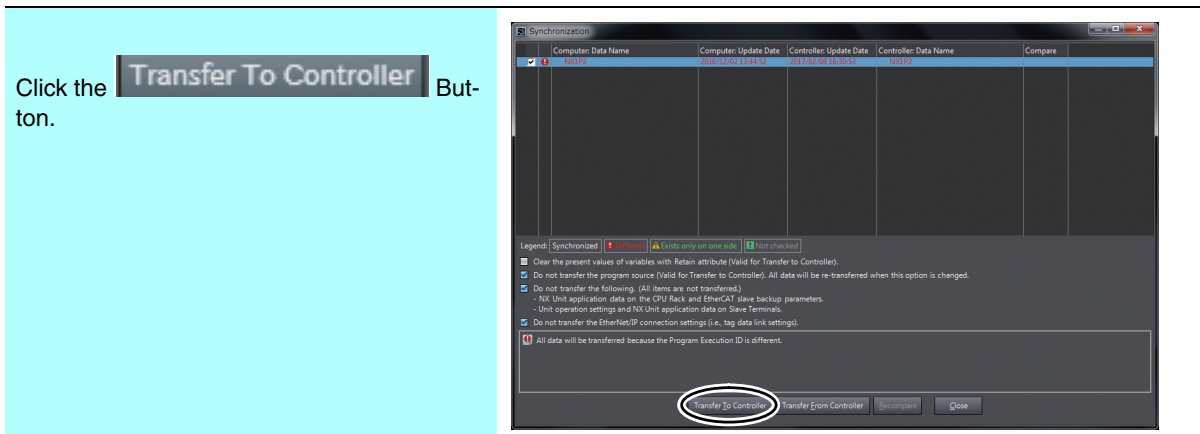

3 Click the **Yes** Button.

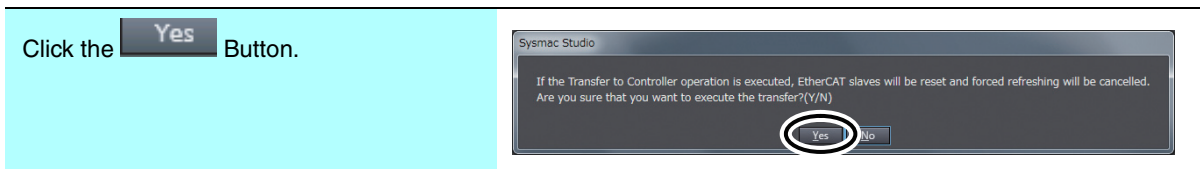

The operating mode changes to PROGRAM mode, and the Sysmac Studio starts transferring the project to the CPU Unit. During the transfer, a progress bar appears in the Synchronize Pane.

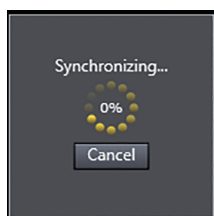

4 The following dialog box is displayed when the transfer is completed. Click the **No** Button. Do not change to RUN mode at this time (i.e., remain in PROGRAM mode).

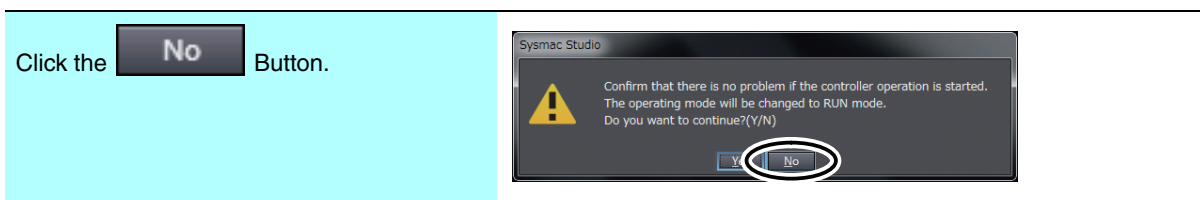

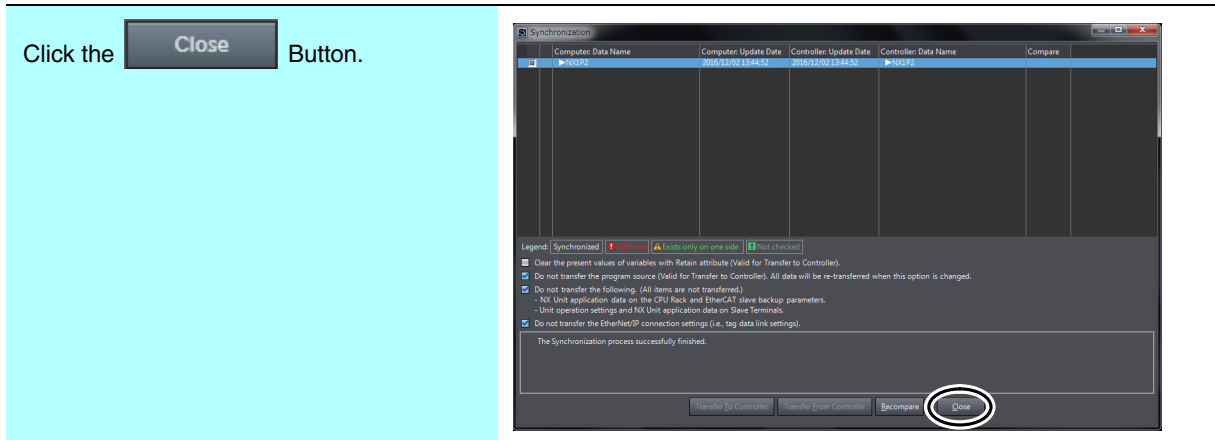
5 Click the **Close** Button at the lower right of the Synchronize Pane.

The Synchronize Pane closes.

3-7 Confirming System Operation

Confirm that the system is operating correctly.

Place the CPU Unit online with the Sysmac Studio before you perform the procedures that are given in this section.

3-7-1 Checking for Controller Errors

The color of the ERR/ALM indicator in the Controller Status Pane of the Sysmac Studio shows the presence of any errors. If ERR/ALM is red, an error has occurred. Follow the instructions that are given below to check the details of the error.

- 1 Click the  Button on the Toolbar of the Controller Status Pane.

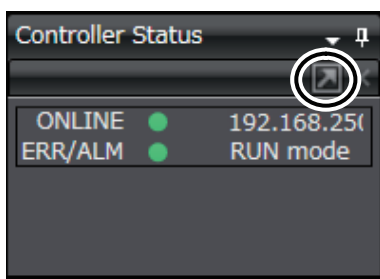

The Detailed View of the Controller Status Pane is displayed.

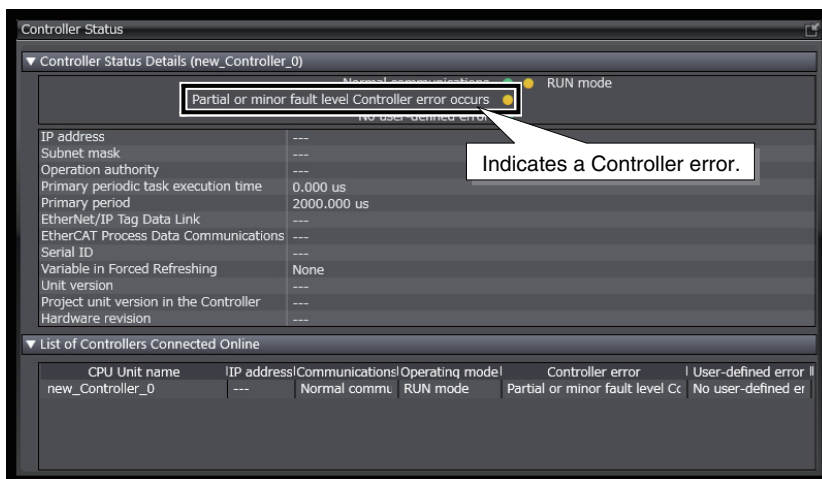

- 2 Use one of the following methods to open the Troubleshooting Window.

Method 1: Select **Troubleshooting** from the Tools Menu.



Method 2: Click the  Button on the Toolbar.

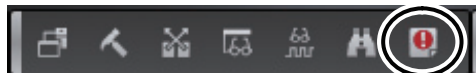

The Troubleshooting Window is displayed for the Edit Pane.

From there, you can check detailed information on any errors that have occurred and find out how to troubleshoot them.

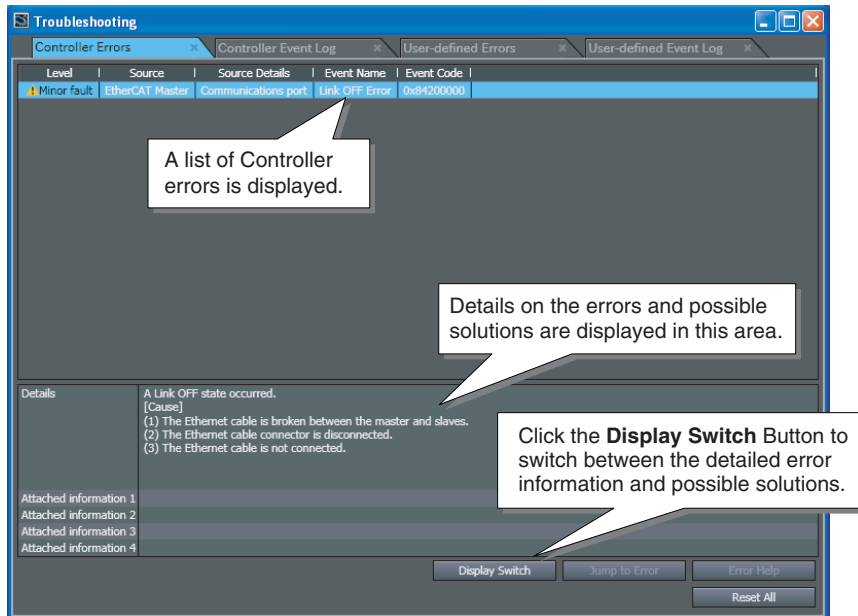

3 Refer to the error details and troubleshooting information to solve the problems and eliminate all errors.

4 Click the **Reset All** Button in the Troubleshooting Window.



The following confirmation dialog box appears.

5 Click the **Yes** Button.

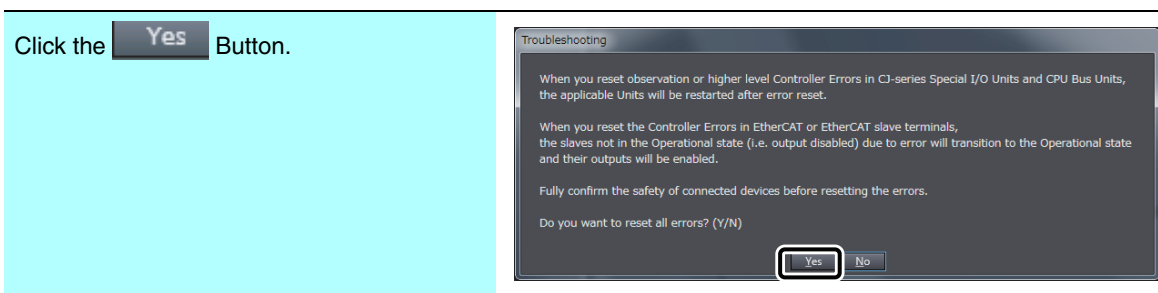

All errors are reset.

If the cause of the error is not removed, the error will occur again.



Additional Information

- If an EtherCAT communications cable is not properly connected or if power is not supplied to a Remote I/O Unit, a minor fault level Controller error (a Link OFF Error or Network Configuration Verification Error) will occur. If you are sure that all EtherCAT communications cables are properly connected, first check to make sure that power is being supplied to the Remote I/O Units before you reset the errors.
 - If you use the default Servo parameters, you must wire the immediate stop input, negative drive prohibit input, and the positive drive prohibit input.
If these inputs are not wired, the CPU Unit will remain in the drive prohibit signal and emergency stop signal detected state, and a minor fault level Controller error will occur. The minor fault level Controller errors that will occur are an Immediate Stop Input Error and a Drive Prohibition Input Error. (The event codes are 68220000 and 64E30000.)
If the above signals are temporarily not wired while commissioning the system, you can temporarily change the Servo parameters to prevent these errors from occurring in the CPU Unit. Refer to *A-1 Settings When Control Input Signals Are Not Wired* for details on the settings that you must change in this case.
-

3-7-2 Resetting the Absolute Encoder from the Sysmac Studio

The absolute encoder must be set up the first time it is used, and when the rotation data is initialized to 0.

- 1 Right-click the Servo Drive and select **Setup and Tuning** from the menu.

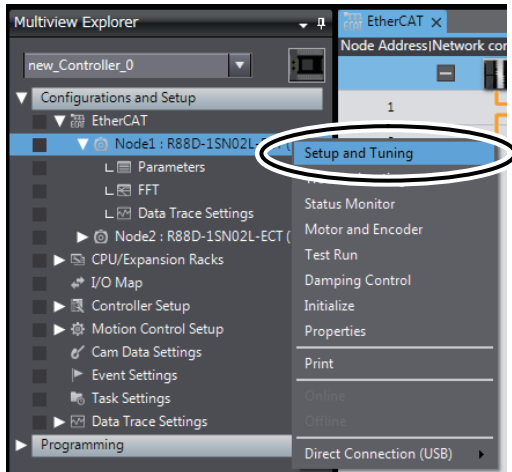

The Setup and Tuning Portal appears.

- 2 Click the **Quick Parameter Setup and I/O Monitor** Button.

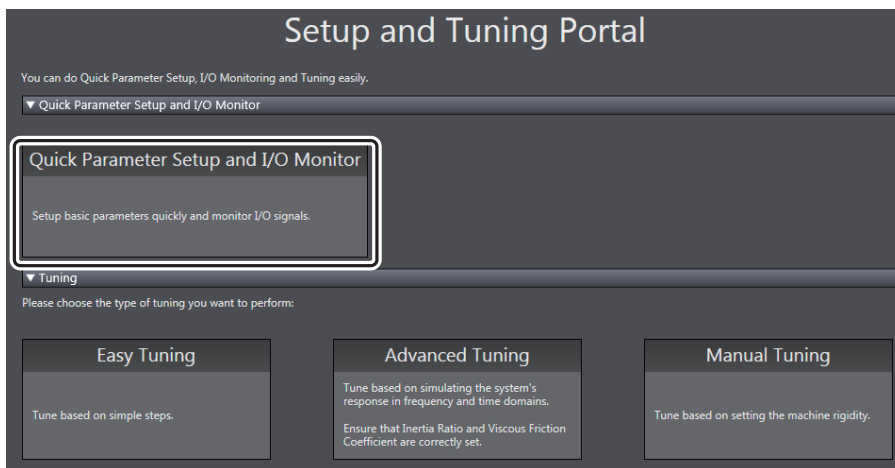

The following dialog box appears. Click the **Yes** Button.

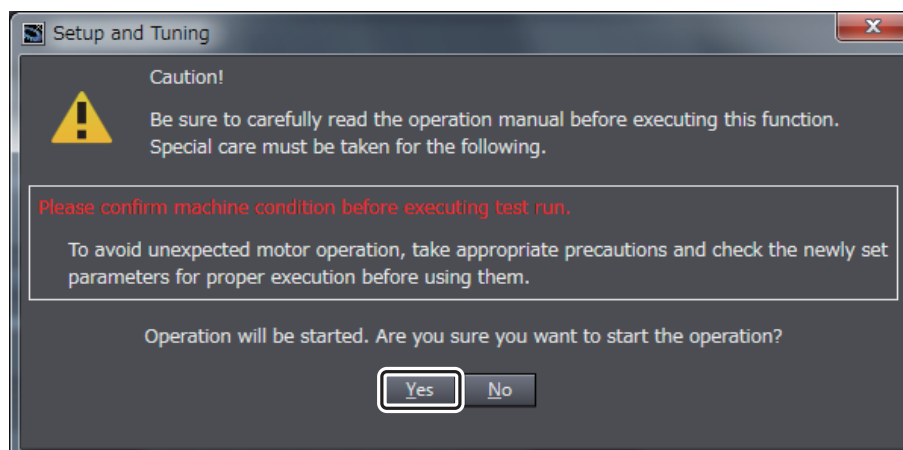

The Motor and Encoder setting Page appears.

3 Click the **Launch Motor and Encoder view** Button.

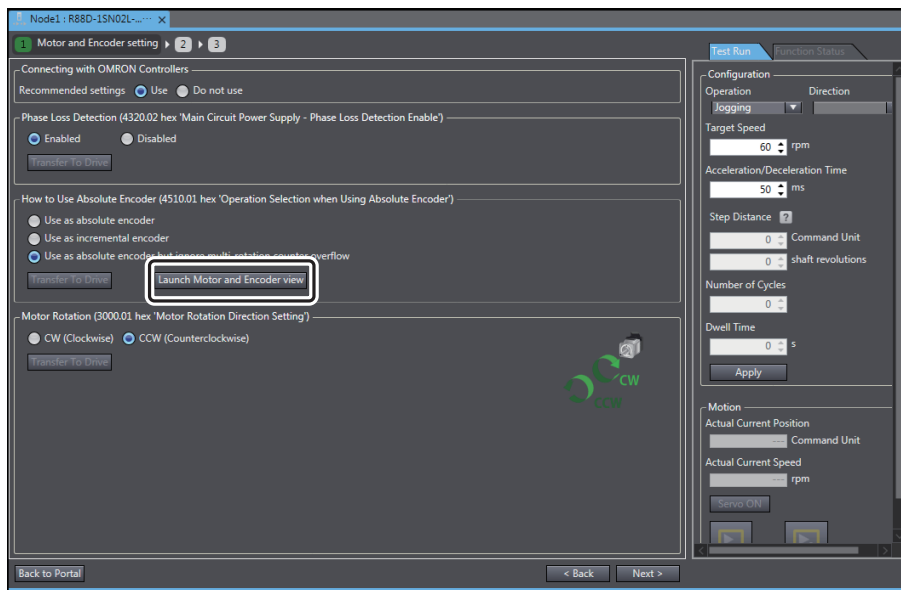

The Encoder Properties Tab Page appears.

4 Click the **Clear system** Button.

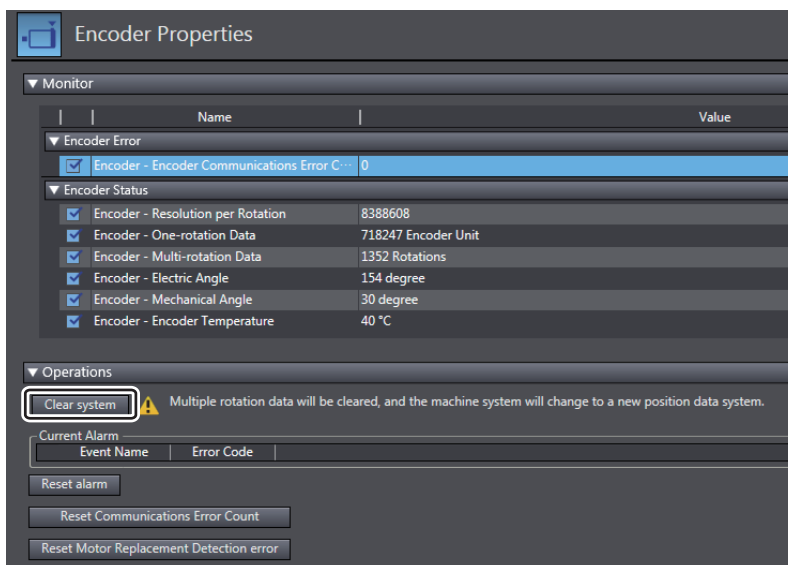

An Absolute Value Clear Error (error display number: 2701) will occur, and a dialog box indicating "Restart the drive to complete the operation."

5 Click the **Yes** Button.

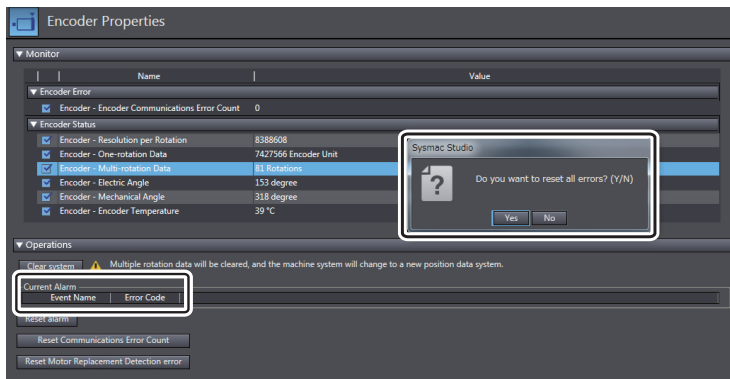

The multiple rotation data of the absolute encoder is cleared.

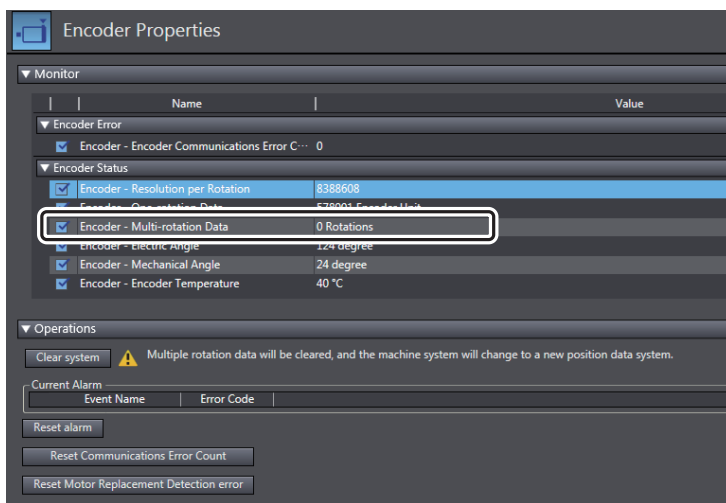

3-7-3 Checking the Servo Drive Wiring

Use the MC Test Run operation in the Sysmac Studio to check the wiring of the Servo Drive.

The wiring is checked in PROGRAM mode to prevent a user program for which operation has not been verified from affecting the wiring confirmation results. In this Guide, the project is transferred in PROGRAM mode.

An MC Test Run allows you to perform tasks such as monitoring the control inputs of an OMRON Servo Drive that has been assigned to an axis or operating the Servomotor without any user programming. Use this to check the Servo Drive wiring and the operation of the Servomotor.

Starting an MC Test Run

Start an MC Test Run from the Sysmac Studio.

- 1 Right-click **MC_Axis000(0)** under **Configurations and Setup - Motion Control Setup - Axis Settings** in the Multiview Explorer, and select **Start MC Test Run** from the menu.

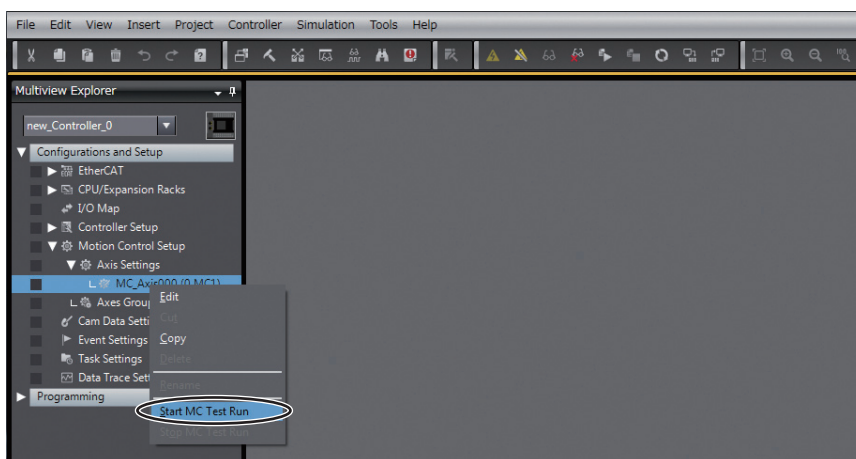

- 2** When the following caution dialog box appears, read the message carefully. After you confirm safety, click the **OK** Button.

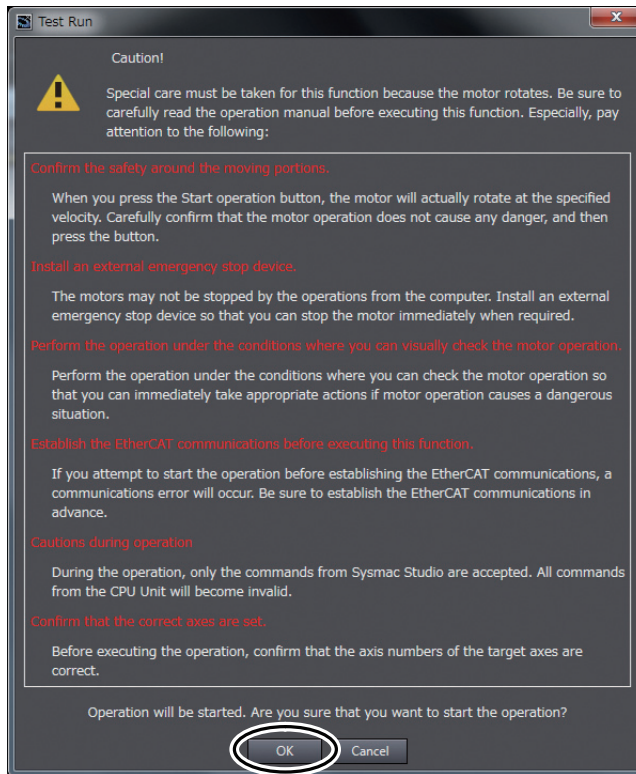

The MC Test Run Tab Page is displayed in the Edit Pane.

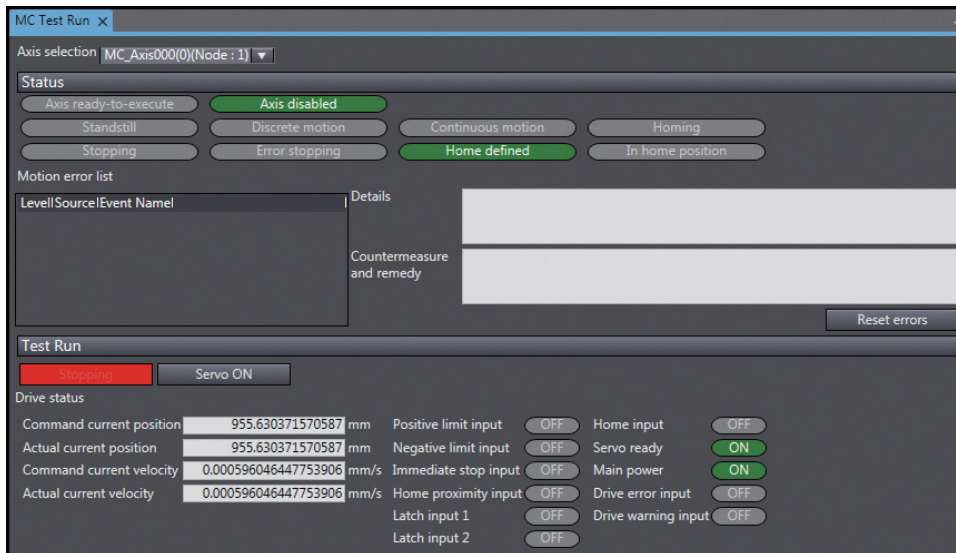

Checking the Control Input Signal Wiring

Use the control input signal status indicators on the MC Test Run Tab Page in the Sysmac Studio to check the wiring of the control input signals.

- 1 Select the axis to check on the MC Test Run Tab Page.

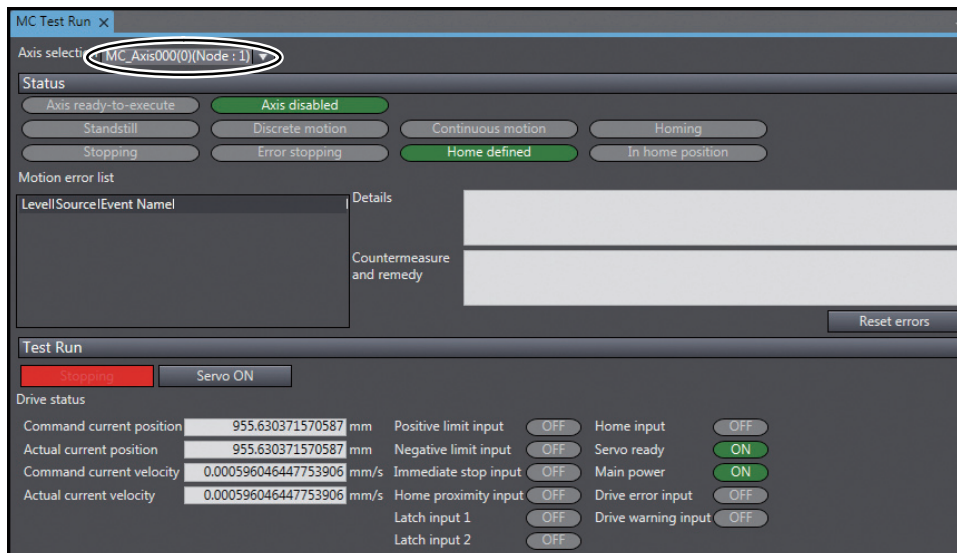

- 2 Check to see if the signals turn ON and OFF properly on the monitor screen by turning ON and OFF the sensor connected to each control input signal.



Checking the Servomotor Wiring

Use the MC Test Run Tab Page in the Sysmac Studio to check the Servomotor wiring.



Precautions for Correct Use

- When one of the following operations is performed for a command from the Sysmac Studio, the Servomotor will operate at the set velocity: Servo ON, jogging, relative positioning, absolute positioning, or homing.
Always confirm that it is safe for the Servomotor to operate before executing any of these operations.
- When operating the Controller from the Sysmac Studio, always install external emergency circuits so that the Servomotor can be stopped safely whenever necessary. The Sysmac Studio may not be able to send commands under some circumstances, e.g., if an error occurs in the computer.
- Set the EtherCAT communications and establish communications before you attempt to perform operation from the Sysmac Studio.

● Servo ON

You can use the **Servo ON** Button to turn the Servo ON and OFF.

- 1 Select the axis to check on the MC Test Run Tab Page.

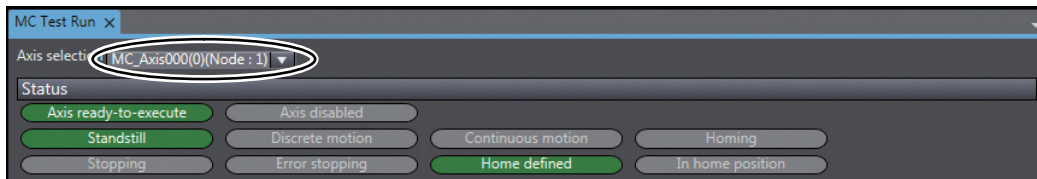

- 2 Click the **Servo ON** Button.

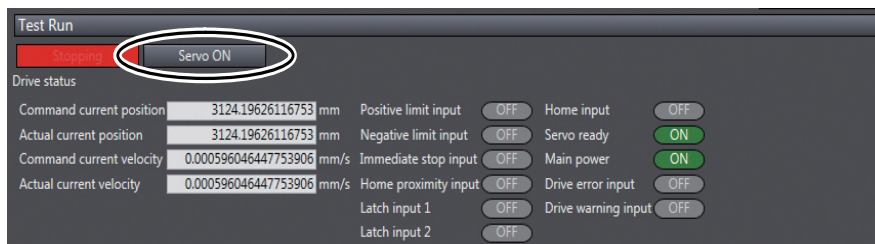

The Servo is turned ON for the selected axis.

Click the **Servo OFF** Button in this state to turn the Servo OFF.

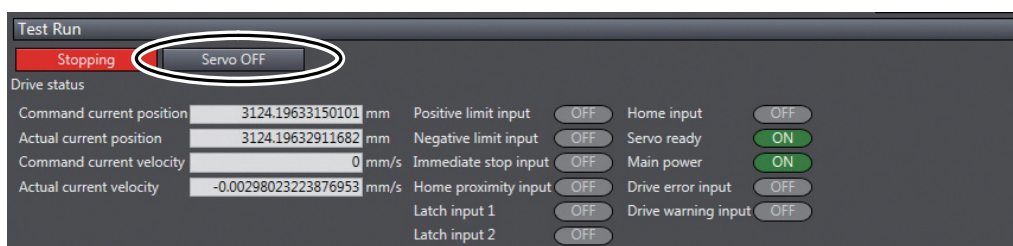

● **Jogging**

Jog the axis in the Servo ON state.

- 1 Click the Jogging Tab on the MC Test Run Tab Page.

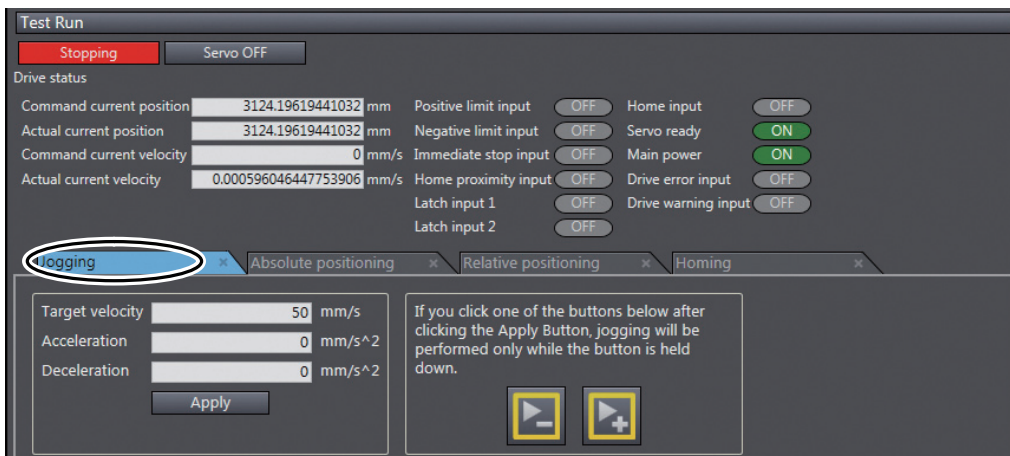

- 2 Enter the target velocity, acceleration rate, and deceleration rate, and then click the **Apply** Button. For this example, set the target velocity to 50.

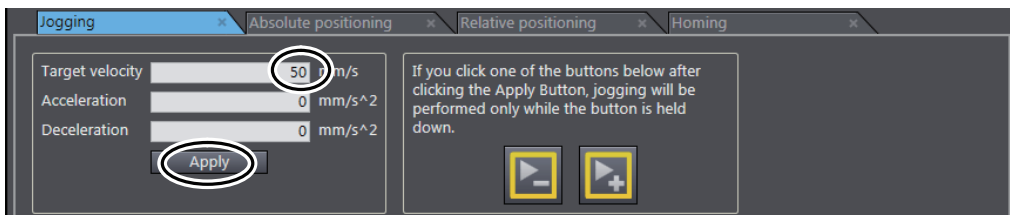

- 3 Click the  Button or the  Button.

The motor will operate in either the positive or negative direction while one of these buttons is clicked.

Check to see if the motor operates in the set direction.

Ending the MC Test Run

After you have checked the wiring of the control input signals and the Servomotor, end the MC Test Run operation.

- 1 Right-click **MC_Axis000(0)** under **Configurations and Setup - Motion Control Setup - Axis Settings** in the Multiview Explorer, and select **Stop MC Test Run** from the menu.

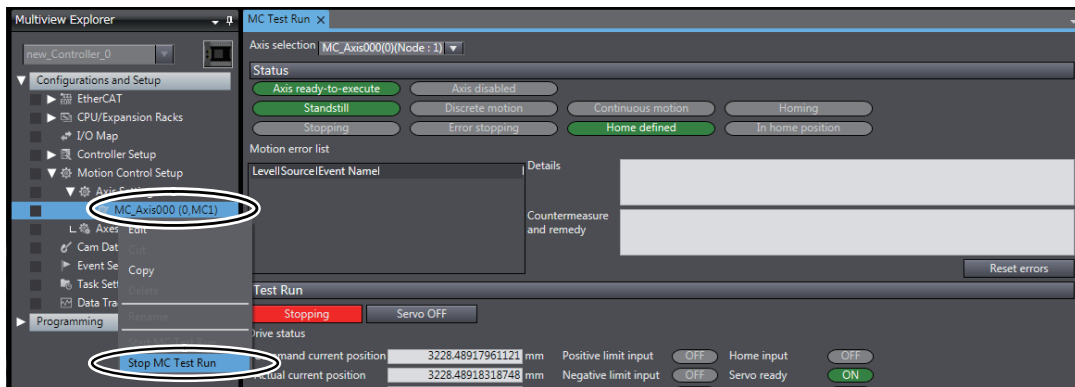

This ends the MC Test Run operation.

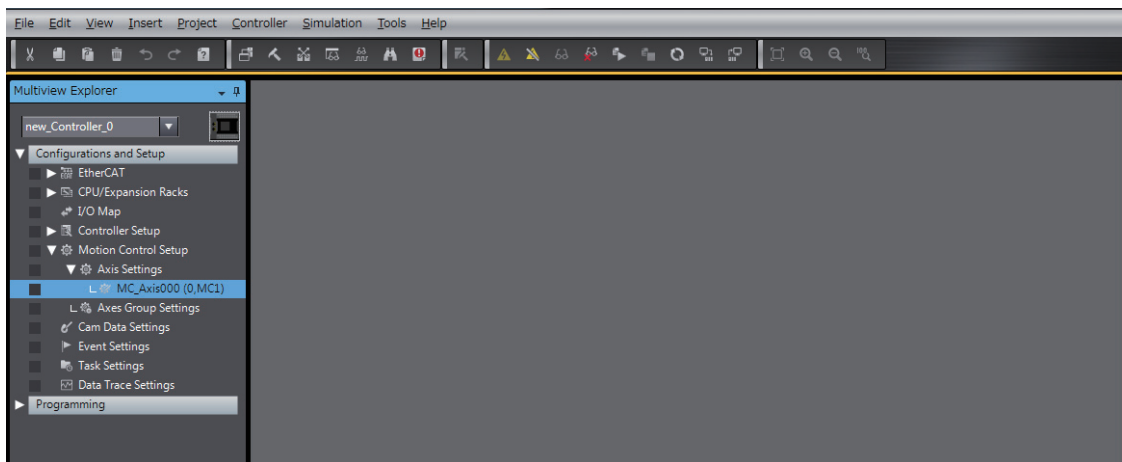

3-7-4 Checking Program Operation

You will change the operating mode of the CPU Unit to RUN mode and then use monitoring, control BOOL variables (set/reset), and use the MC Monitor Table in the Ladder Editor to check the operation of the program that you created. Control (set/reset) the status of the inputs to control the motion control instructions, and use the MC Monitor Table to check the results of their execution.

- 1 Double-click **Section0** under **Programming – POU’s – Programs – Program0** in the Multiview Explorer.

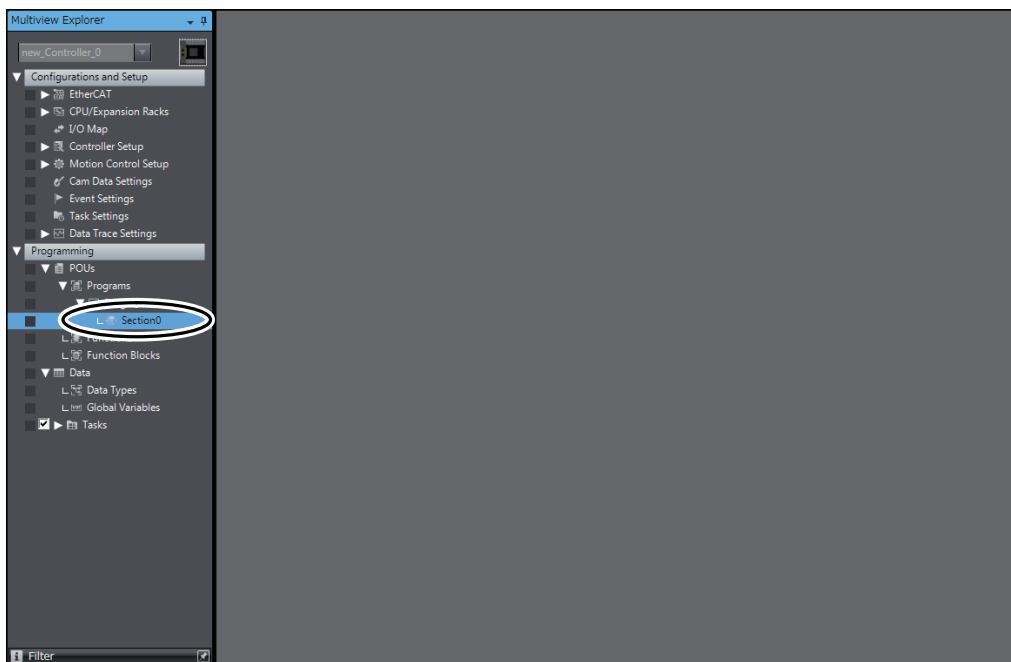

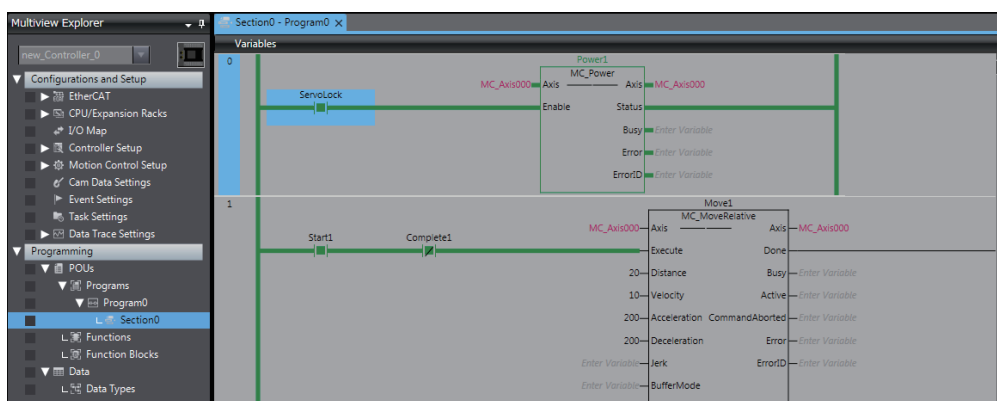

The ladder program is displayed in the monitored state in the Edit Pane.



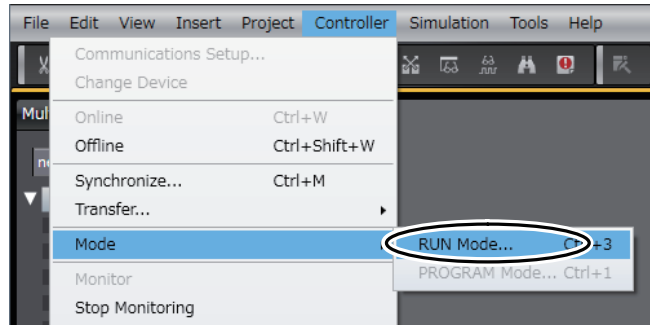

2 Use one of the following methods to change the operating mode to RUN mode.

Method 1: Select **Mode – RUN Mode** from the Controller Menu.



Method 2: Click the  Button on the Toolbar.



Method 3: Press the  **Ctrl +**  **3** Keys.

3 The following dialog box is displayed. Confirm that no problem will occur even if you change the operating mode, and then click the **Yes** Button.

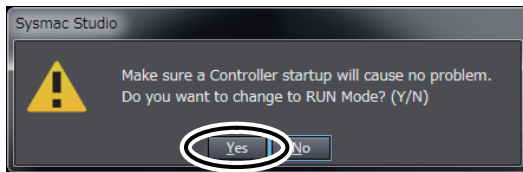

- 4 Right-click *ServoLock* in the program in the Edit Pane, and then select **Set/Reset - Set** from the menu.

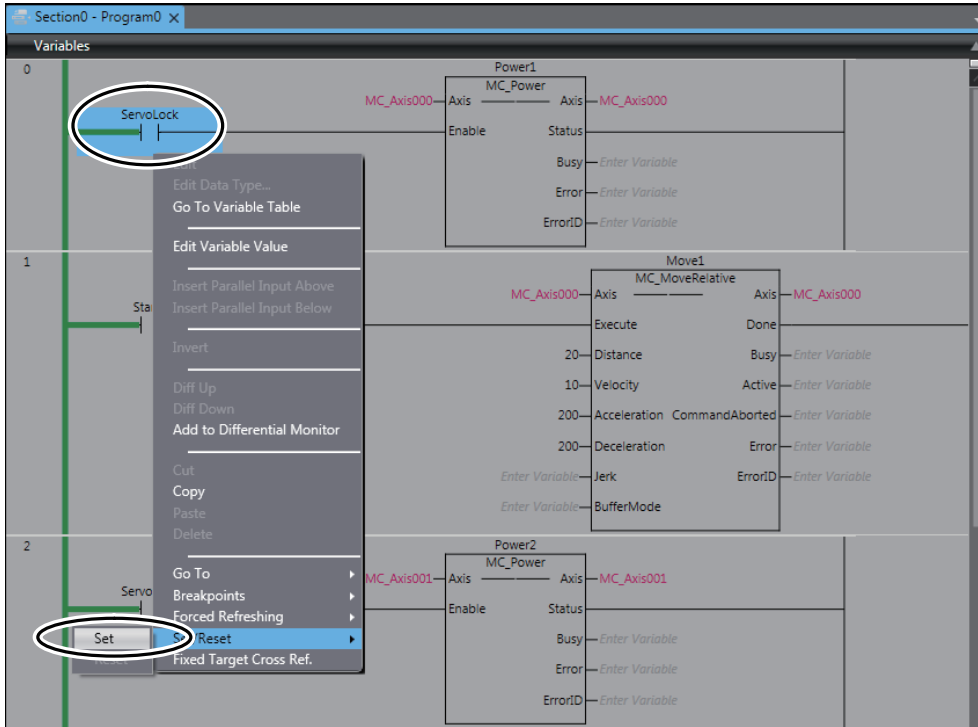

ServoLock changes to TRUE, and *Power1* is executed.

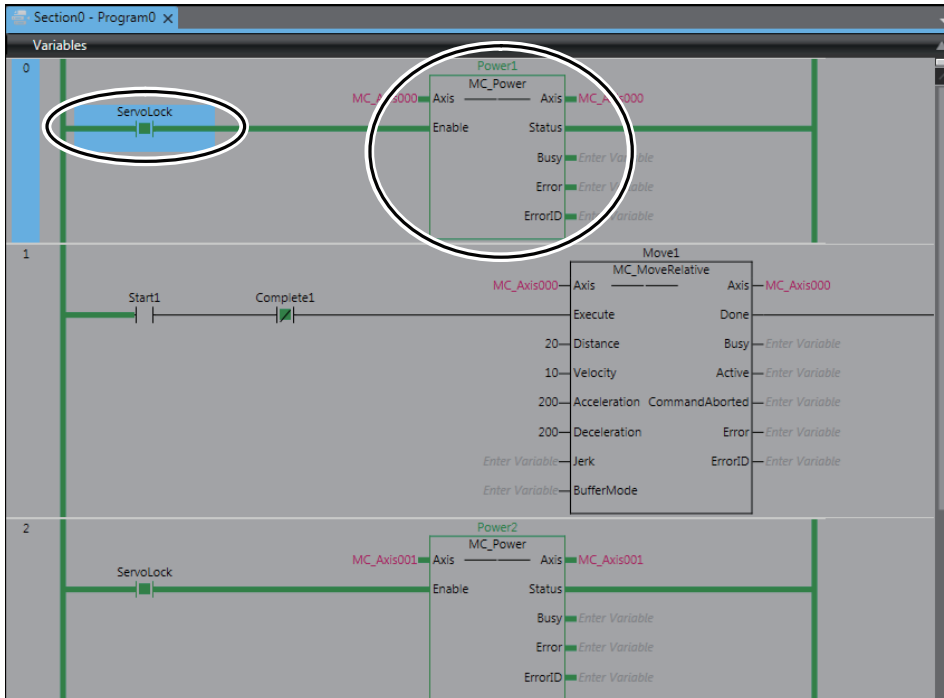

- 5 Right-click *Start* in the program in the Edit Pane, and then select **Set/Reset - Set** from the menu.

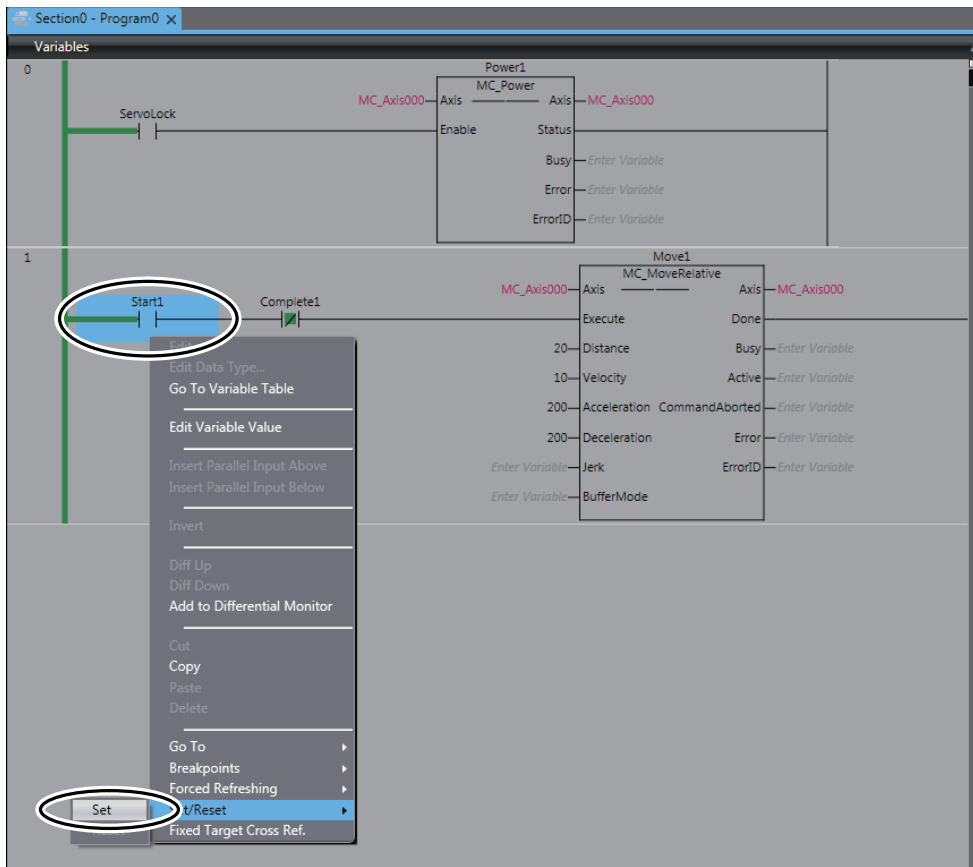

Start1 changes to TRUE.

Move1 is executed and positioning is started. When the positioning for *Move1* is completed, *Move1* execution stops and *Move2* is executed. This operation is repeated.

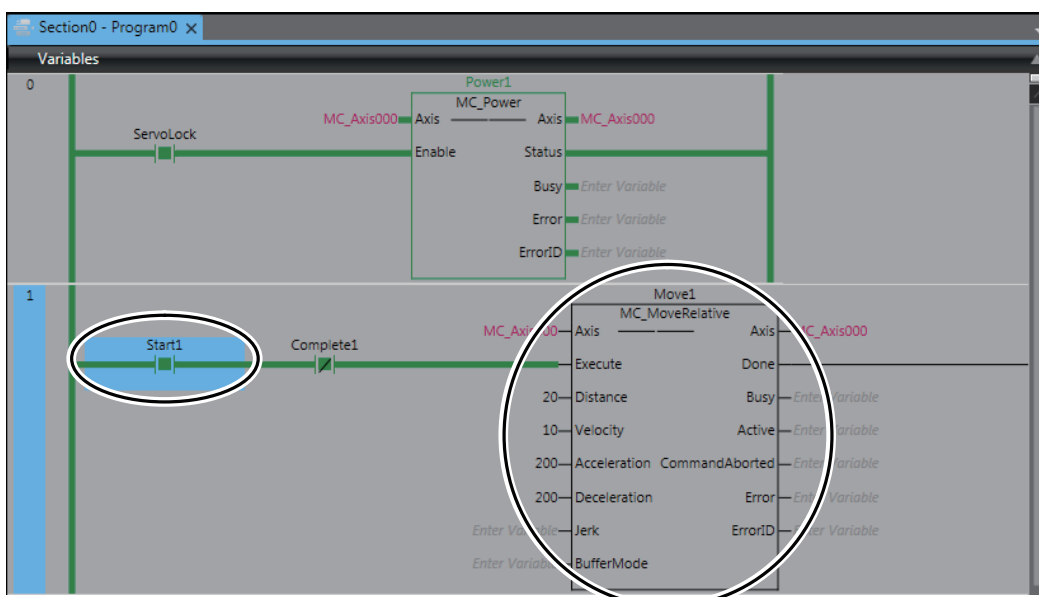

- 6 Right-click **Axis Settings** under **Configurations and Setup - Motion Control Setup** in the Multiview Explorer, and select **MC Monitor Table** from the menu.

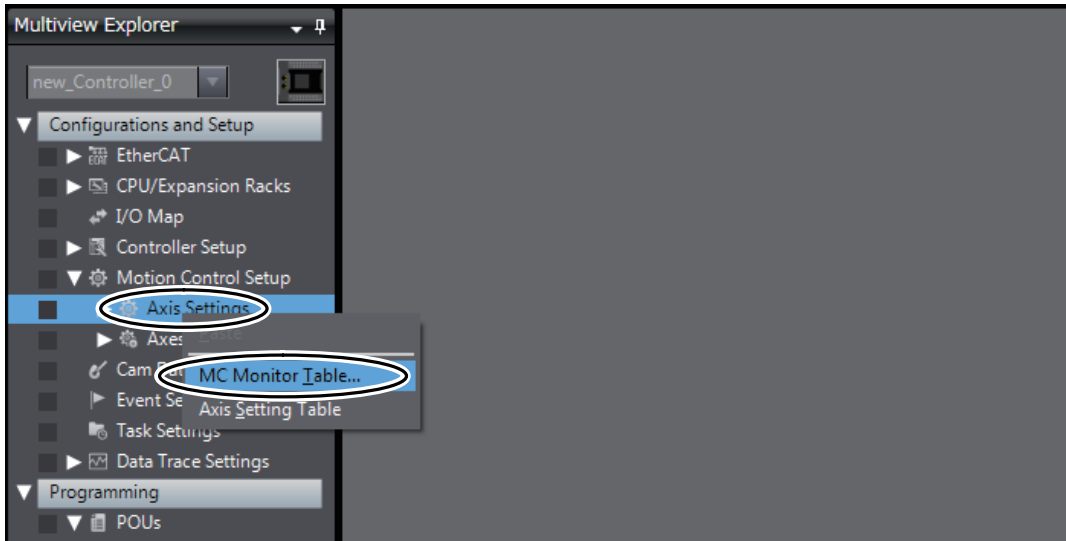

The MC Monitor Table Tab Page is displayed in the Edit Pane.

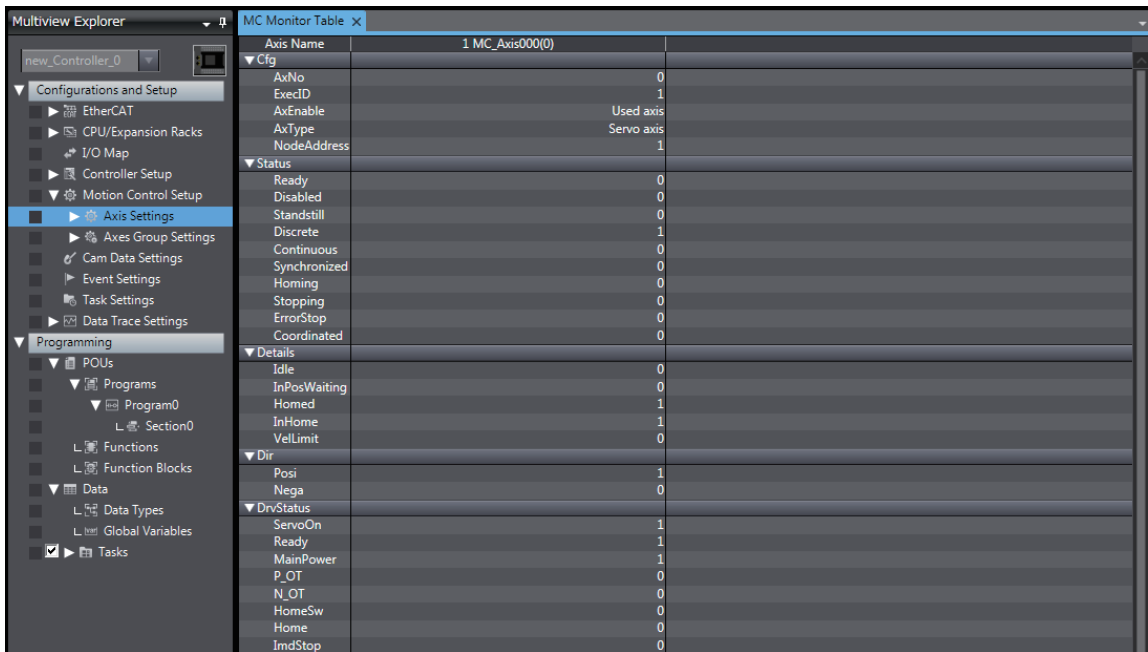

- 7 Use the MC Monitor Table to confirm that the axis is moving.
- a* and *b* in the following figure show the information that you need to check.
- *a*: Check that the value of *Pos* under *Cmd* is either increasing or decreasing.
 - *b*: Check that the value of *Pos* under *Act* is either increasing or decreasing.

MC Monitor Table X		1 MC_Axis000(0)
Axis Name		1 MC_Axis000(0)
Synchronized		0
Homing		0
Stopping		0
ErrorStop		0
Coordinated		0
▼ Details		
Idle		0
InPosWaiting		0
Homed		1
InHome		0
Vellimit		0
▼ Dir		
Posi		1
Nega		0
▼ DrvStatus		
ServoOn		1
Ready		1
MainPower		1
P_OT		0
N_OT		0
HomeSw		0
Home		0
ImdStop		0
Latch1		0
Latch2		0
DrvAlarm		0
DrvWarning		0
ILA		0
CSP		1
CSV		0
CST		0
▼ Cmd		
Pos	18.51 mm	
Vel	9.99999999999999979 mm/sec	
Trq	0	
▼ Act		
Pos	18.4899997711182 mm	
Vel	10.000467300415 mm/sec	
Trq	0	
TimeStamp	0	
▼ MFaultLVI		
Active		0
Code		0

3-7-5 Using Data Tracing to Check Operation

Use data tracing to check the current operation.

- 1 Right-click **Data Trace Settings** under **Configurations and Setup** in the Multiview Explorer and select **Add – Data Trace** from the menu.

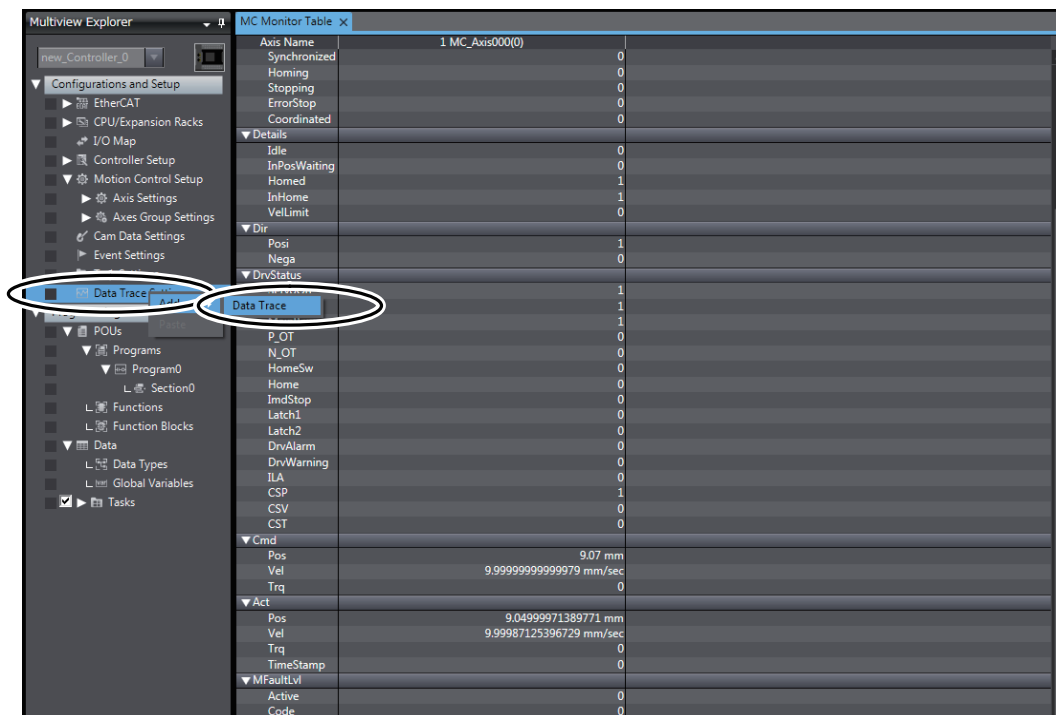

DataTrace0 is added to the Multiview Explorer.

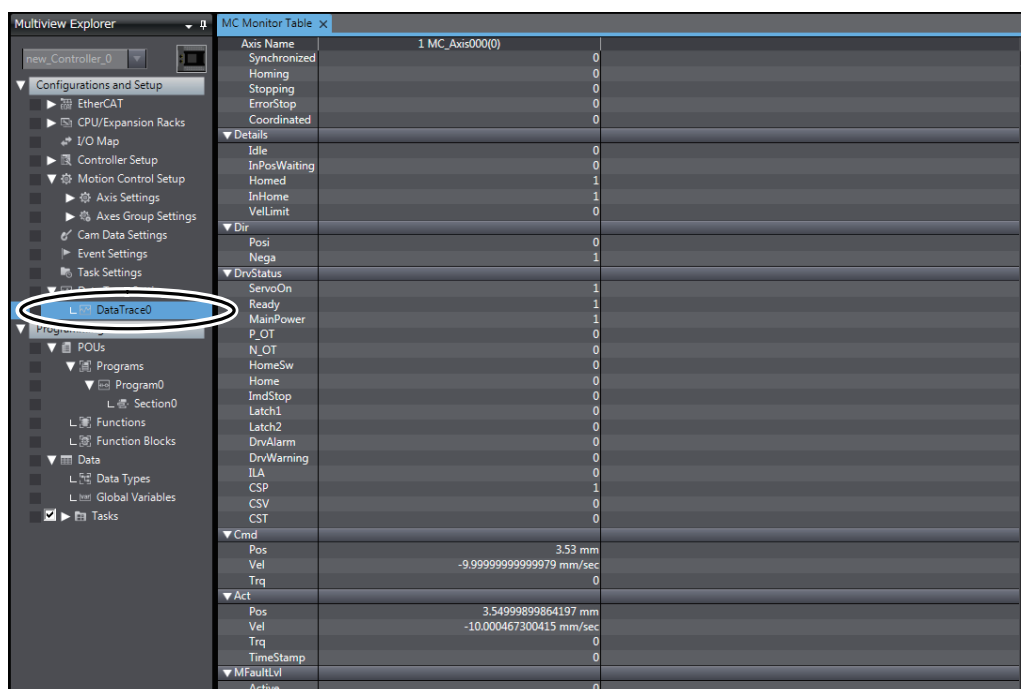

2 Double-click the new **DataTrace0** item in the Multiview Explorer.

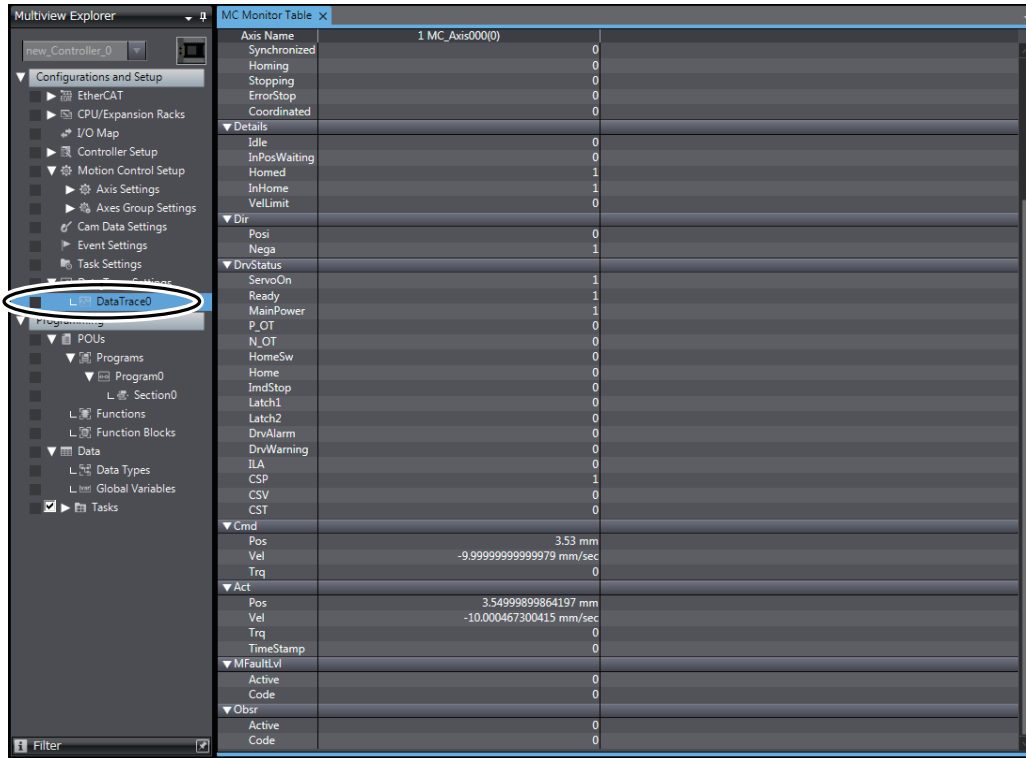

The DataTrace0 Tab Page is displayed in the Edit Pane.

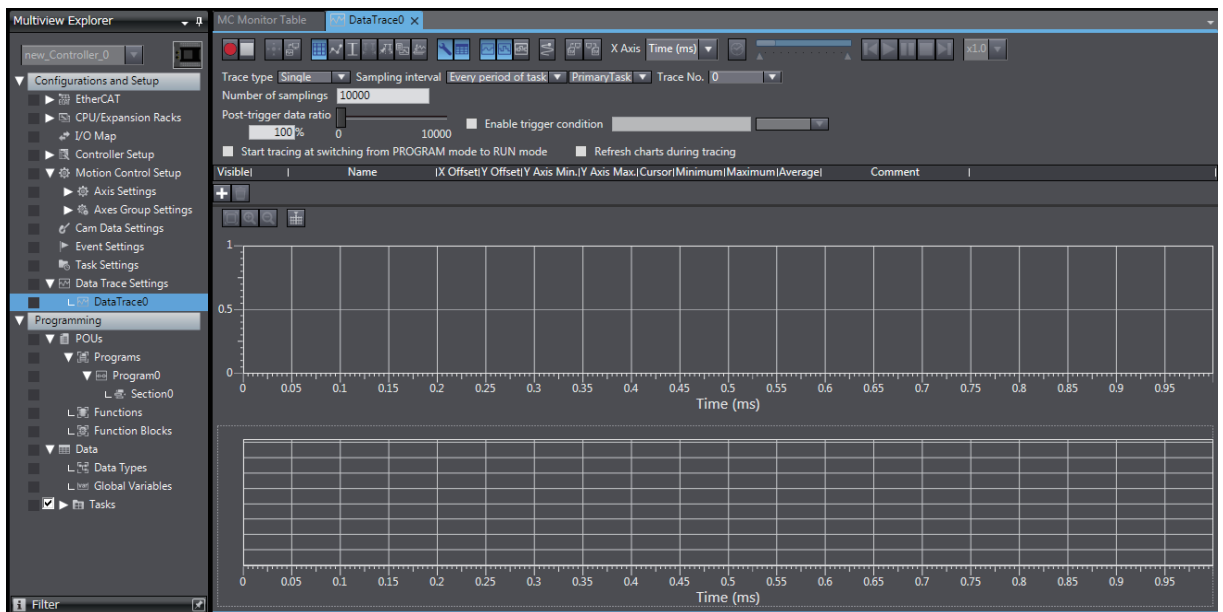

- 3 Select the *Enable trigger condition* Check Box on the DataTrace0 Tab Page and enter the variable to use as the trigger condition. For this example, use *Program0.Move1.Execute*.

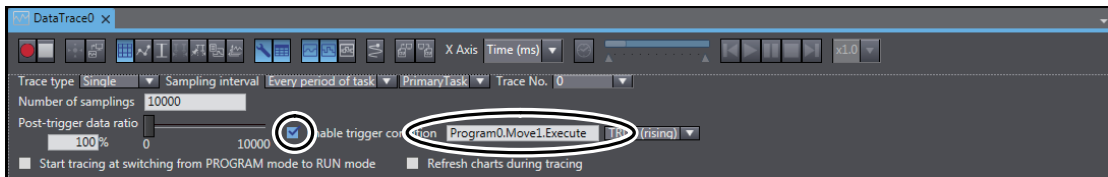

- 4 Click the **Add Target** Button.

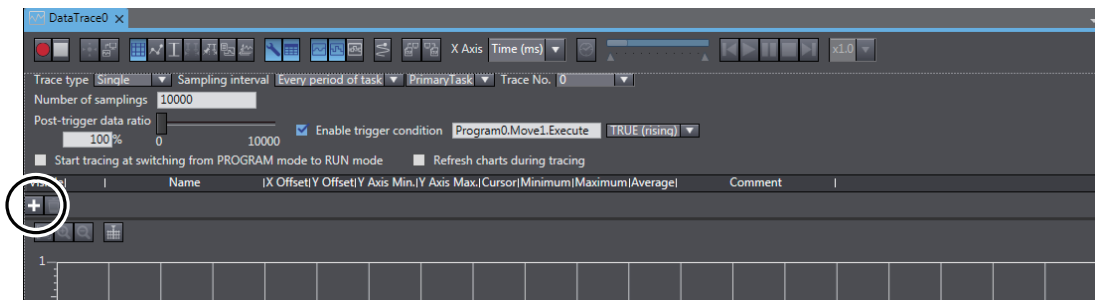

A trace variable line is added to the list.

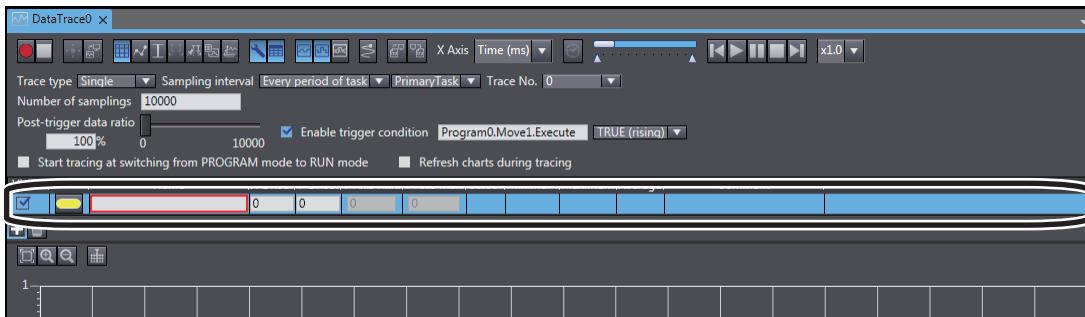

5 Enter *MC_Axis000.Cmd.Vel* for the name of the variable to trace on the new line.

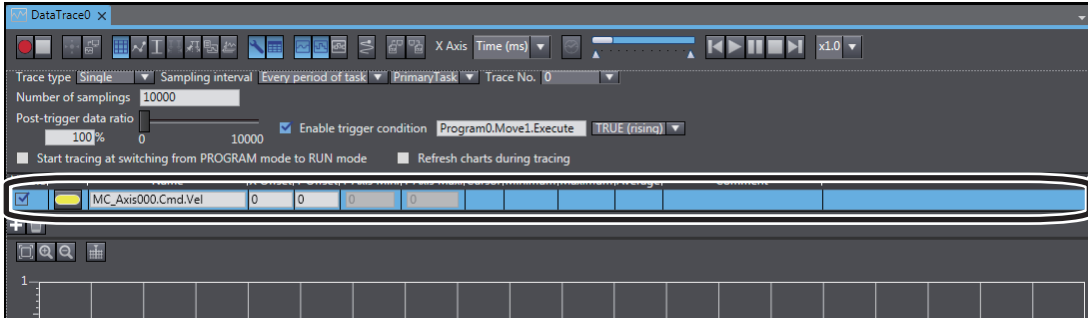

6 Click the **Start Trace** Button.

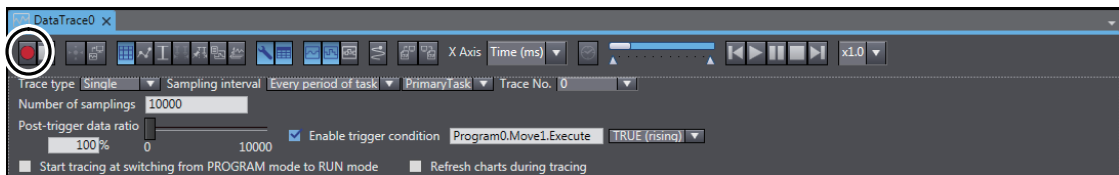

7 Make sure that the status bar at the lower left changes as shown in the following figure.

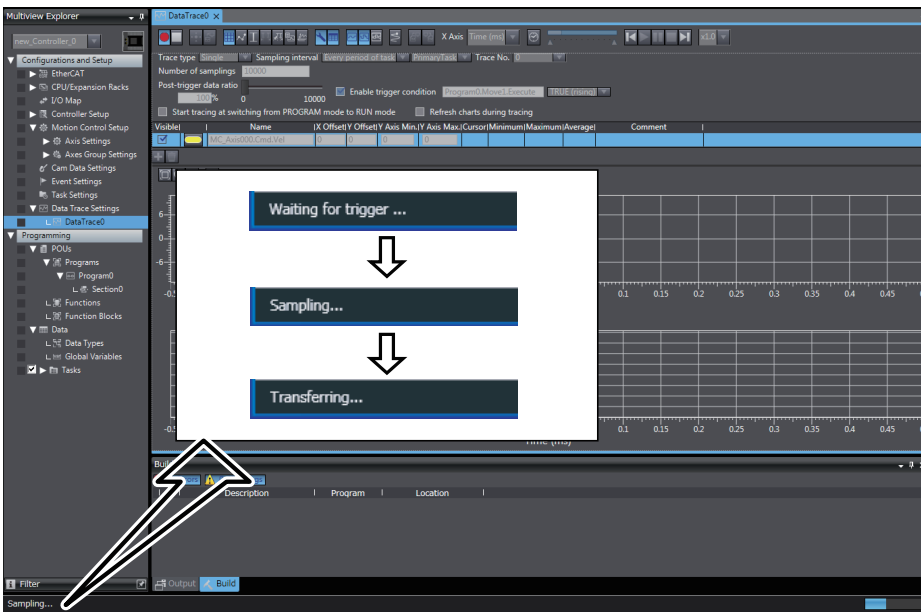

8 Make sure that the results of the data trace are displayed.

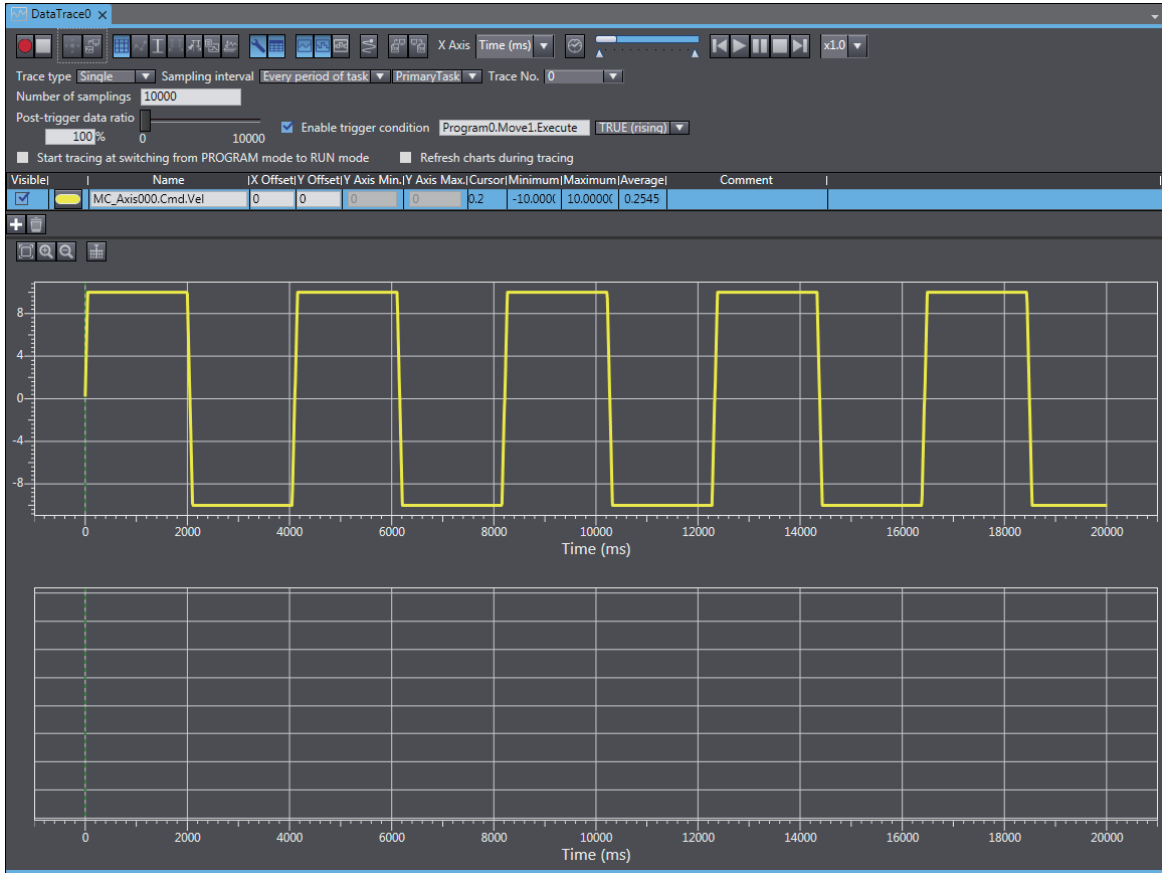

Make sure that the trace results show the same waveform as shown in *3-1 Single-axis Servo System Operation*.

4

Two-axis Linear Interpolation Program

This section describes how to add an axis to the single-axis Servo system constructed in *Section 3* to create a two-axis linear interpolation program.

4

4-1	Two-axis Servo System Operation	4-2
4-2	System Setup Procedures	4-3
4-3	Changing the Program	4-4
4-3-1	Setting Axis 0 to a Motion Control Axis	4-4
4-3-2	Adding a Servo Drive to the EtherCAT Network Configuration	4-5
4-3-3	Adding Axis 1 and Setting an Axes Group	4-7
4-3-4	Adding Instructions and Checking the Program	4-15
4-3-5	Transferring the Project to the CPU Unit	4-21
4-4	Confirming System Operation	4-22
4-4-1	Checking the New Axis 1	4-22
4-4-2	Checking Program Operation	4-22
4-4-3	Using Data Tracing to Check Operation	4-29

4-1 Two-axis Servo System Operation

This section describes the operation of the two-axis Servo system that is set up in this Guide.

In this system, axis 0 and axis 1, which are set up for an XY stage, will repeatedly travel between two points using linear interpolation.

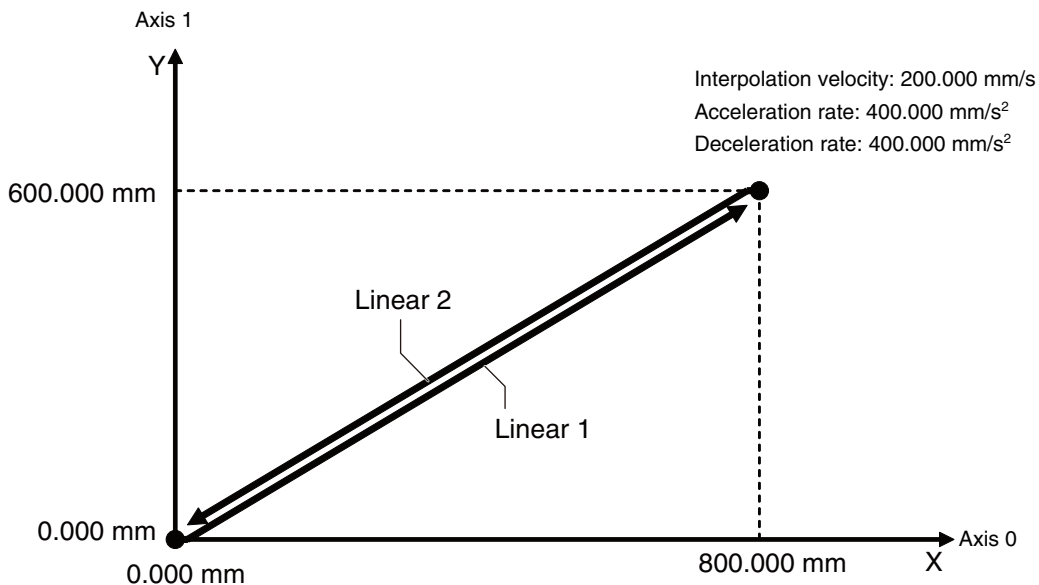

The speed waveforms for axis 0 and axis 1 are shown below.

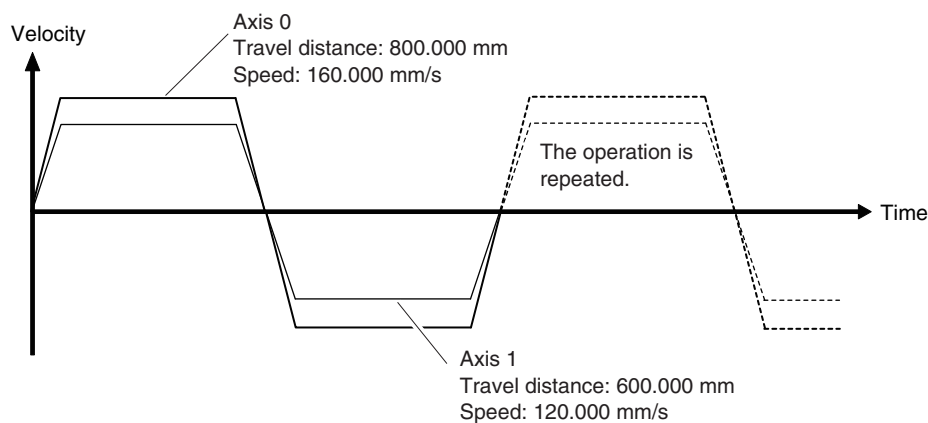

The axis created in *Section 3 Setting Up a Single-axis Servo System* is axis 0. The axis added in this section is axis 1.

The mechanical configuration of axis 1 is the same as that of axis 0. Refer to *3-1 Single-axis Servo System Operation* for the mechanical configuration of axis 0.

4-2 System Setup Procedures

The basic design flow to follow to design a Servo system is shown below.

This section describes how to add a new axis, continuing from the procedures performed in *Section 3 Setting Up a Single-axis Servo System*.

Therefore, any procedures that were completed in *3-2 System Setup Procedures* are not included in this section.

STEP 1. Correct the Program (page 4-4)

Add an axis variable and an axes group variable, and then correct the POU program and check it.

STEP 1-1 Set axis 0 to a motion control axis (page 4-5).

STEP 1-2 Add a Servo Drive to the EtherCAT network configuration (page 4-5).

STEP 1-3 Add axis 1 and set axes group (page 4-7).

STEP 1-4 Add instructions and check the program (page 4-15).

STEP 1-5 Transfer the project to the CPU Unit (page 4-21).



STEP 2. Confirm System Operation (page 4-22)

Perform a check to test system operation. (Use online debugging.)

STEP 2-1 Check program operation (page 4-22).

STEP 2-2 Use data tracing to check operation (page 4-29).

4-3 Changing the Program

Change the program to perform linear interpolation control between two axes.

Correct the program that was created in *Section 3 Setting Up a Single-axis Servo System* as follows:

- Set axis 0 to a motion control axis.
- Add the second Servo Drive to the EtherCAT network configuration.
- Add an axis for the second Servo Drive, and create an axes group that contains axis 0 and axis 1.
- Add programming to perform linear interpolation control.

4-3-1 Setting Axis 0 to a Motion Control Axis

To perform linear interpolation control between two axes, change the setting of axis 0 that was created in *Section 3 Setting Up a Single-axis Servo System* from a single-axis position control axis to a motion control axis.

- 1 Right-click **MC_Axis000** (axis 0) in the Multiview Explorer and select **Edit** from the menu.

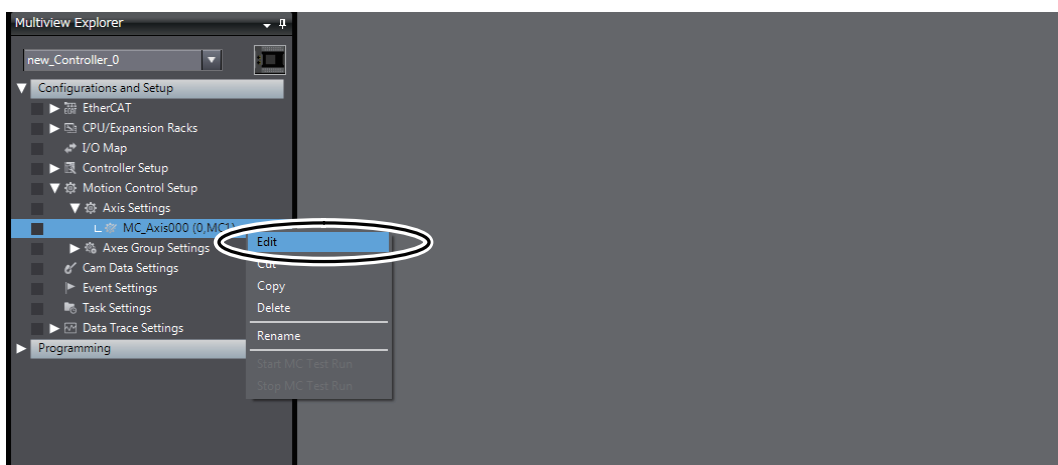

The Axis Basic Settings are displayed on the Axis Parameter Settings Tab Page in the Edit Pane.

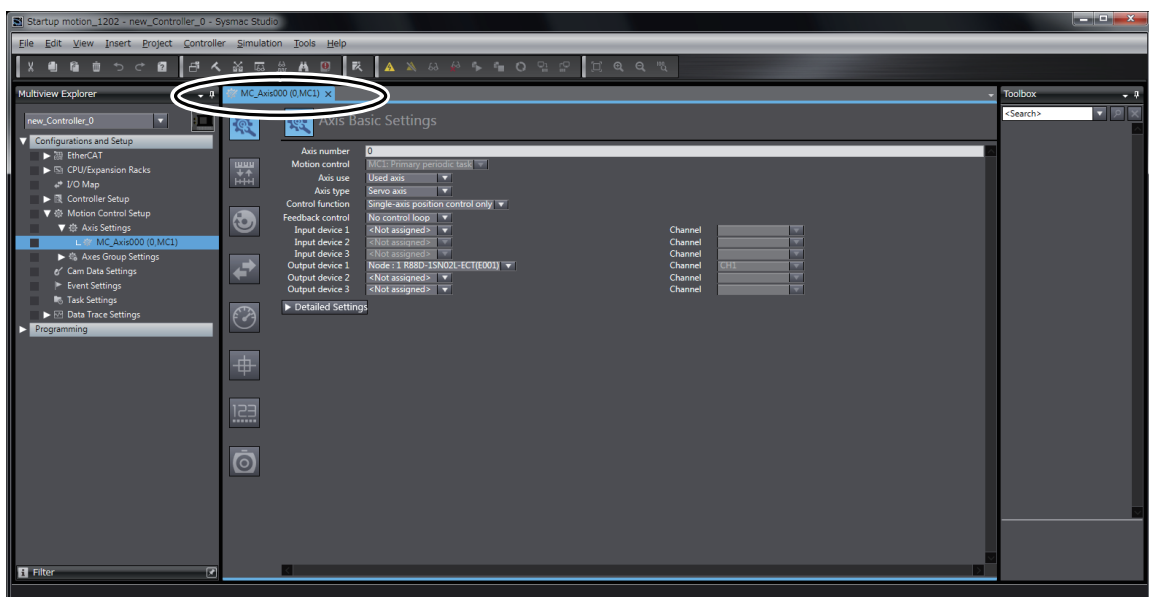

- 2** Select **All** in the *Control function* Box.

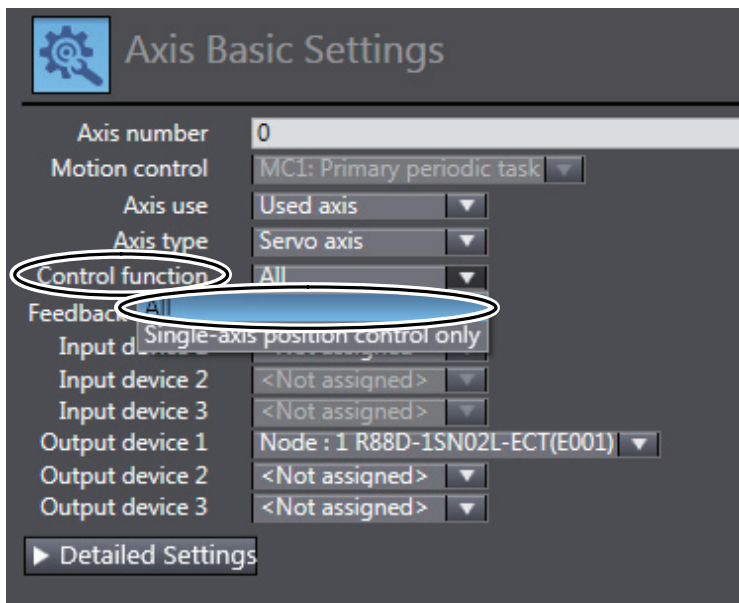

Selecting **All** enables the axis to be used for both single-axis position control and two-axis linear interpolation control.

4-3-2 Adding a Servo Drive to the EtherCAT Network Configuration

A R88D-1SN01L-ECT Servo Drive is added as part of the EtherCAT network configuration that was created in *Section 3 Setting Up a Single-axis Servo System*. This Servo Drive will operate as axis 1.

- 1** Double-click **EtherCAT** under **Configurations and Setups** in the Multiview Explorer.

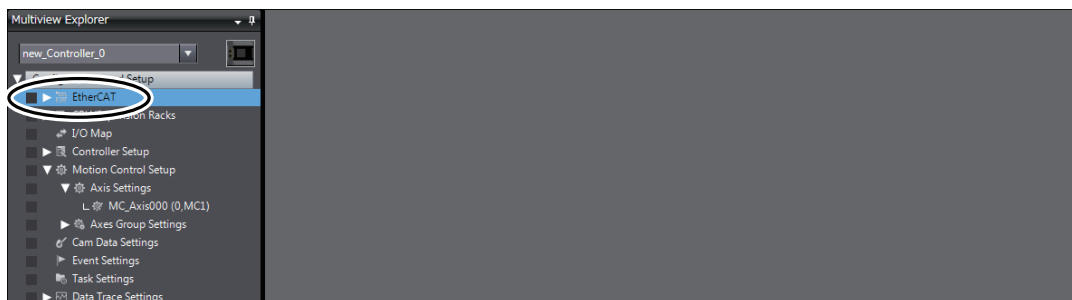

The EtherCAT Tab Page is displayed in the Edit Pane.

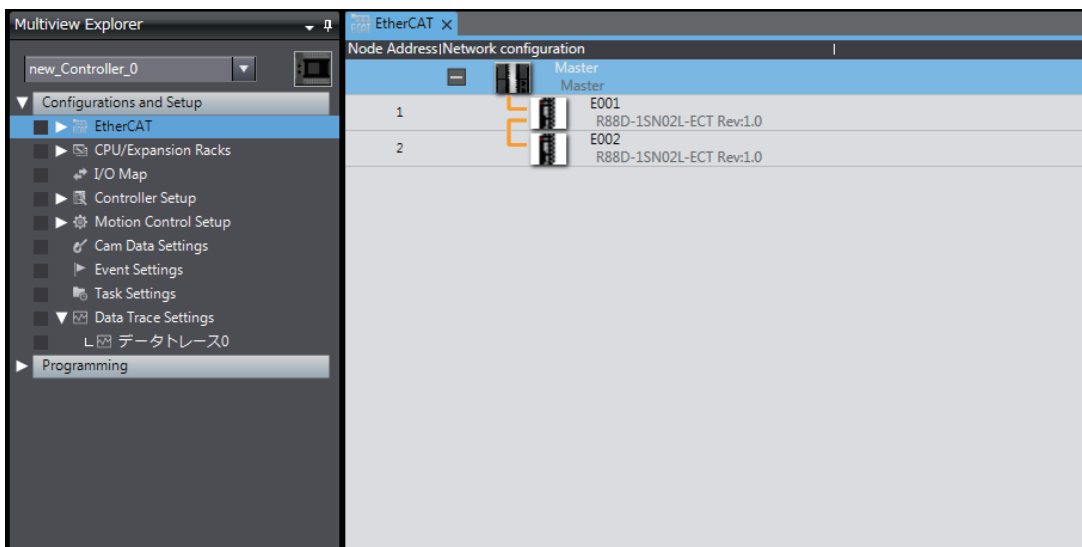

2 Right-click **R88D-1SN01L-ECT** in the Toolbox, and select **Insert** from the menu.

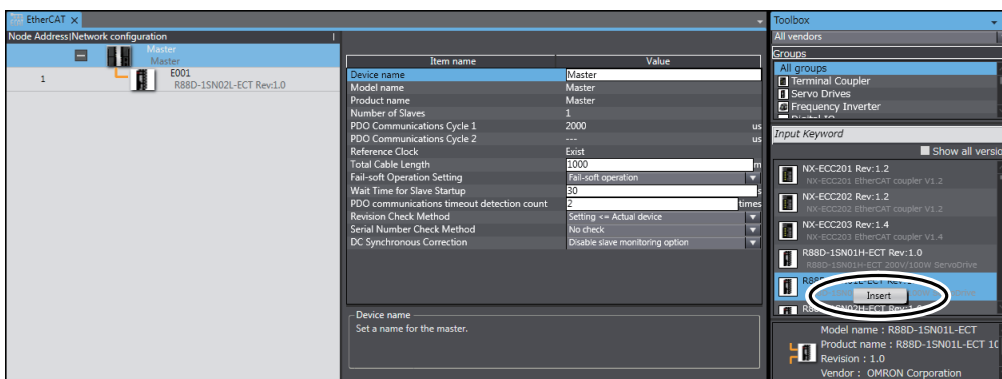

The Servo Drive is added under **E001** with a node address of 2.

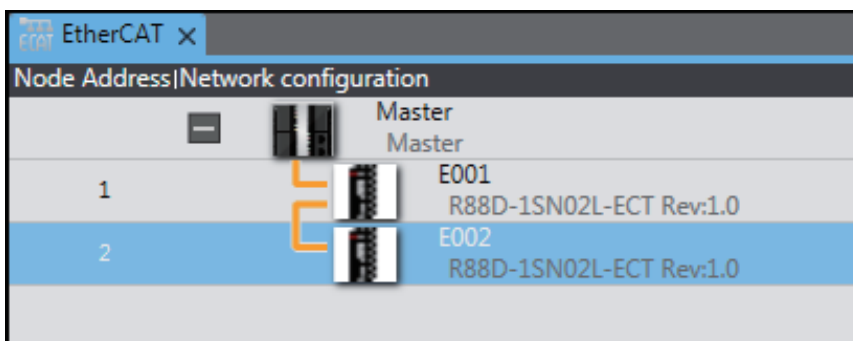

This concludes the creation of the EtherCAT network configuration.

4-3-3 Adding Axis 1 and Setting an Axes Group

Add the axis settings for axis 1, and then set up the axes group to perform interpolation.

● Adding the Axis Settings for Axis 1

- 1 Right-click **Axis Settings** in the Multiview Explorer and select **Add - Motion Control Axis** from the menu.

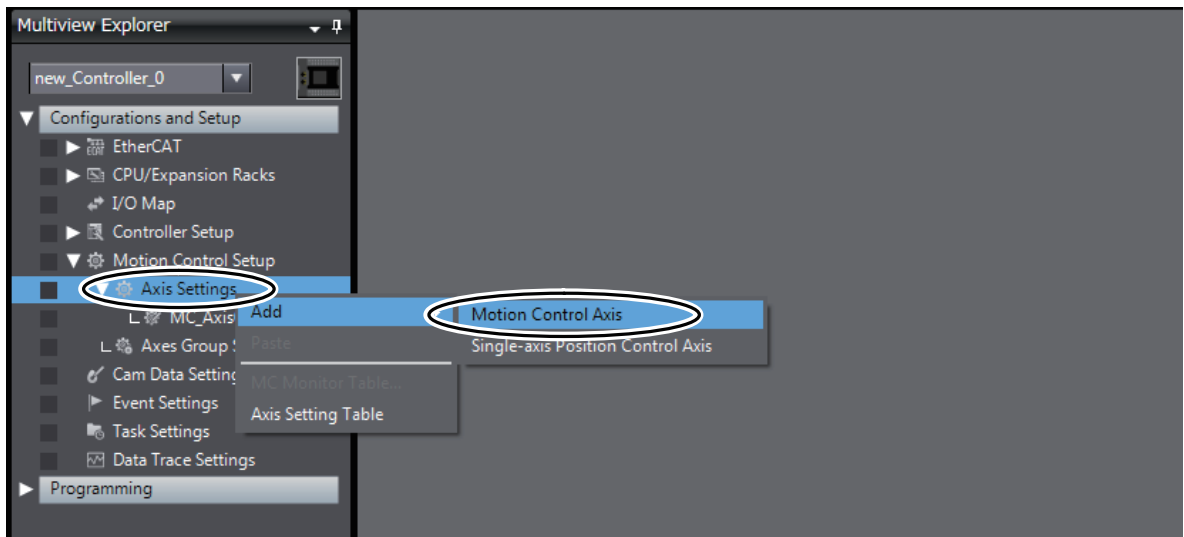

An axis is added to the Multiview Explorer.

The axis is added as *MC_Axis001*. This axis is called axis 1.

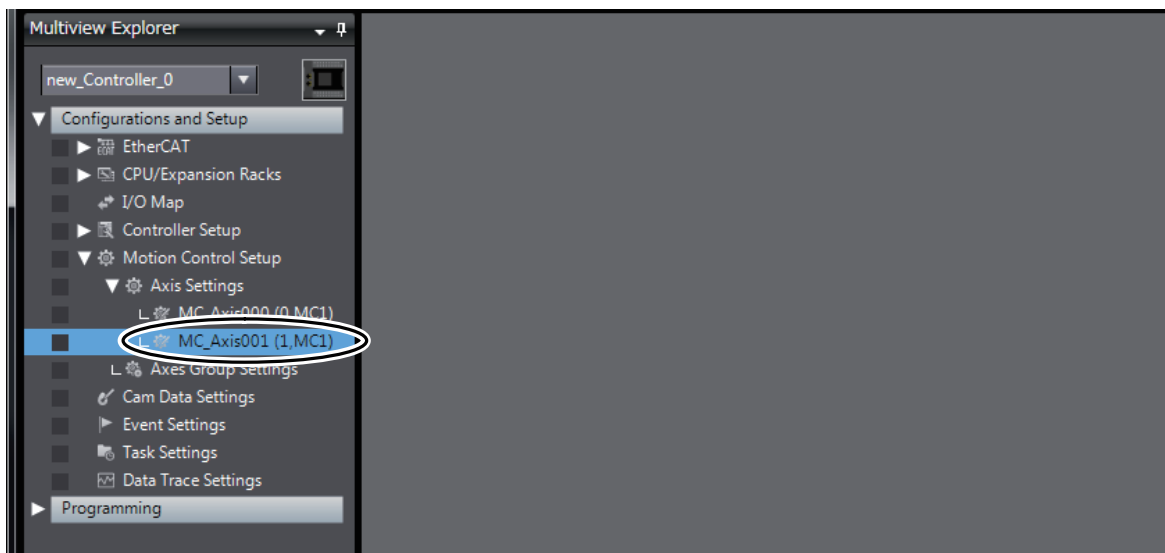

● **Assigning the Axis and Setting the Axis Parameters**

Assign a Servo Drive to *MC_Axis001* (the new axis 1), and set its axis parameters.

You could use the same procedures as described in the *Assigning a Servo Drive to the Axis* on page 3-10 and *Setting the Axis Parameters* on page 3-13 in *3-5-1 Setting the Axis*.

For this example, we will use the Axis Setting Table to copy the settings from axis 0 to axis 1.

- 1 Right-click **Axis Settings** under **Configurations and Setup - Motion Control Setup** in the Multiview Explorer, and select **Axis Setting Table** from the menu.



The Axis Setting Table is displayed in the Edit Pane.

The axis parameters for axis 0 (*1 MC_Axis000(0)*) are already set, but the axis parameters for axis 1 (*2 MC_Axis001(1)*) are still set to their default values.

Axis Name	1 MC_Axis000	2 MC_Axis001
Axis Basic Settings		
Axis number	0	1
Motion control	MC1: Primary periodic task	MC1: Primary periodic task
Axis use	Used axis	Used axis
Axis type	Servo axis	Virtual servo axis
Control function	Single-axis position control only	All
Feedback control	No control loop	No control loop
Input device 1	-	-
Channel	-	-
Input device 2	-	-
Channel	-	-
Input device 3	-	-
Channel	-	-
Output device 1	Node : 1	-
Channel	CH1	-
Output device 2	-	-
Channel	-	-
Output device 3	-	-
Channel	-	-

2 Right-click *1 MC_Axis000(0)* and select **Copy** from the menu.

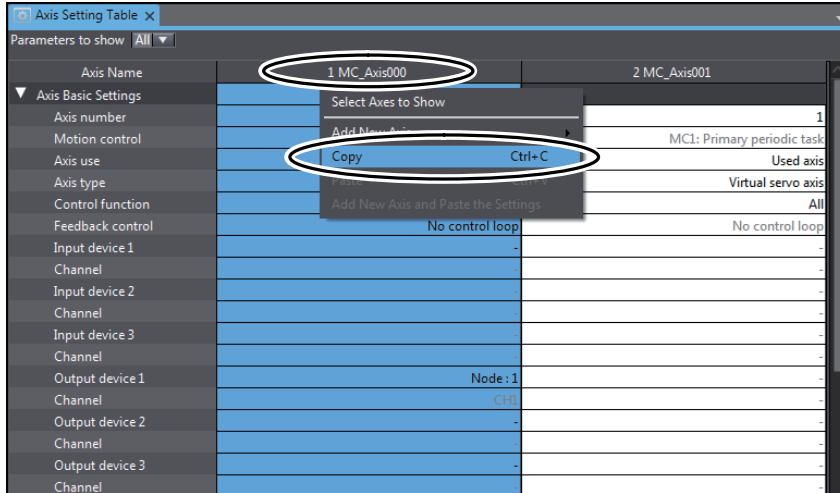

3 Right-click *2 MC_Axis001(1)* and select **Paste** from the menu.

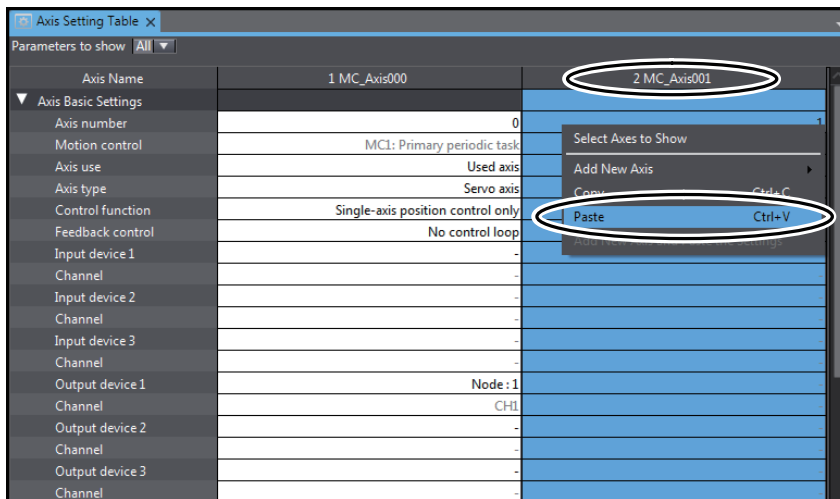

The settings of the axis parameters for axis 0 are copied to axis 1.

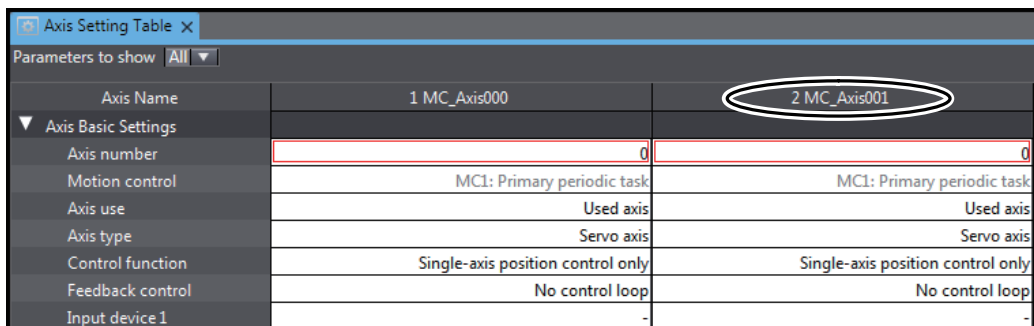

In this state, the input device for axis 1 still needs to be assigned to a Servo Drive.

- 4 Click the *Input device* Cell in the *2 MC_Axis001(1)* column, and select *Node: 2, Device: R88D-1SN01L-ECT*.

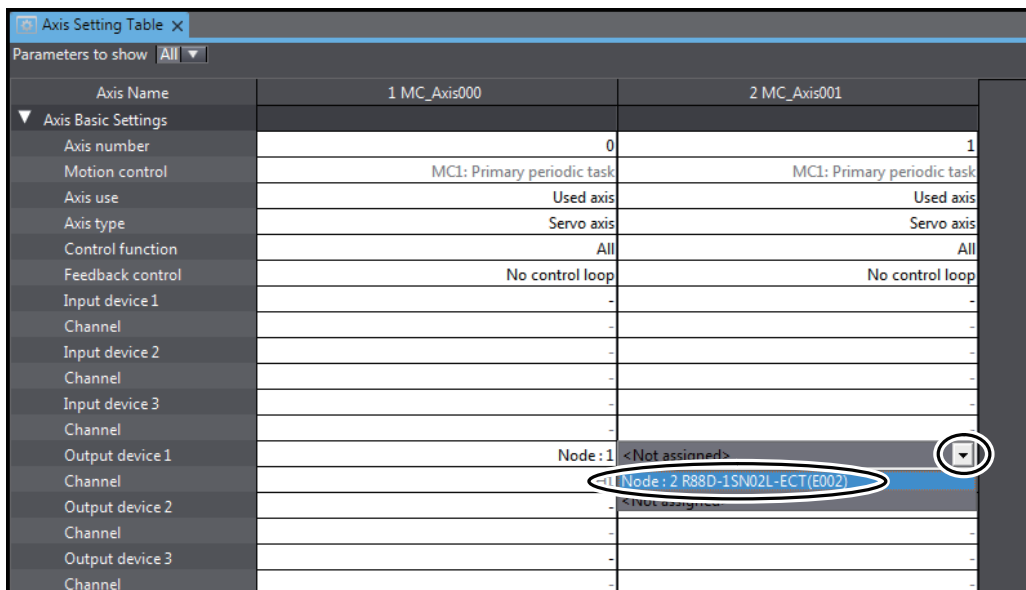

This will assign node 2 and device R88D-1SN01L-ECT as the input device for axis 1.

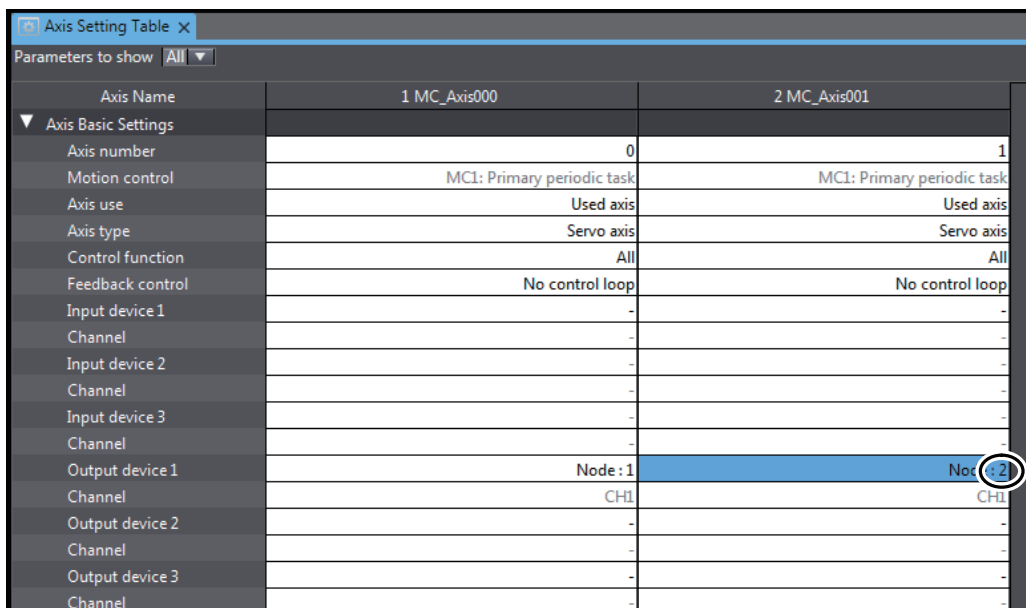

Now, node 2 with device R88D-1SN01L-ECT can be used as an axis in the EtherCAT network configuration.

● Adding Axes Group Settings

- 1 Right-click **Axes Group Settings** under **Configurations and Setup - Motion Control Setup** in the Multiview Explorer and select **Add - Axes Group Settings** from the menu.

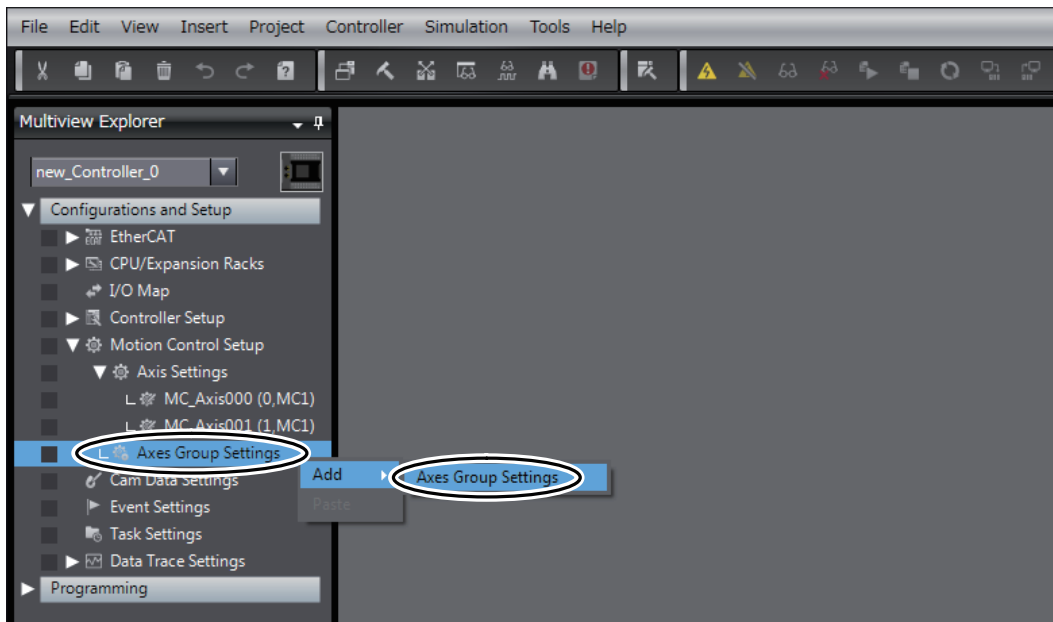

An axes group is added to the Multiview Explorer.

The new axes group is displayed as *MC_Group000*.

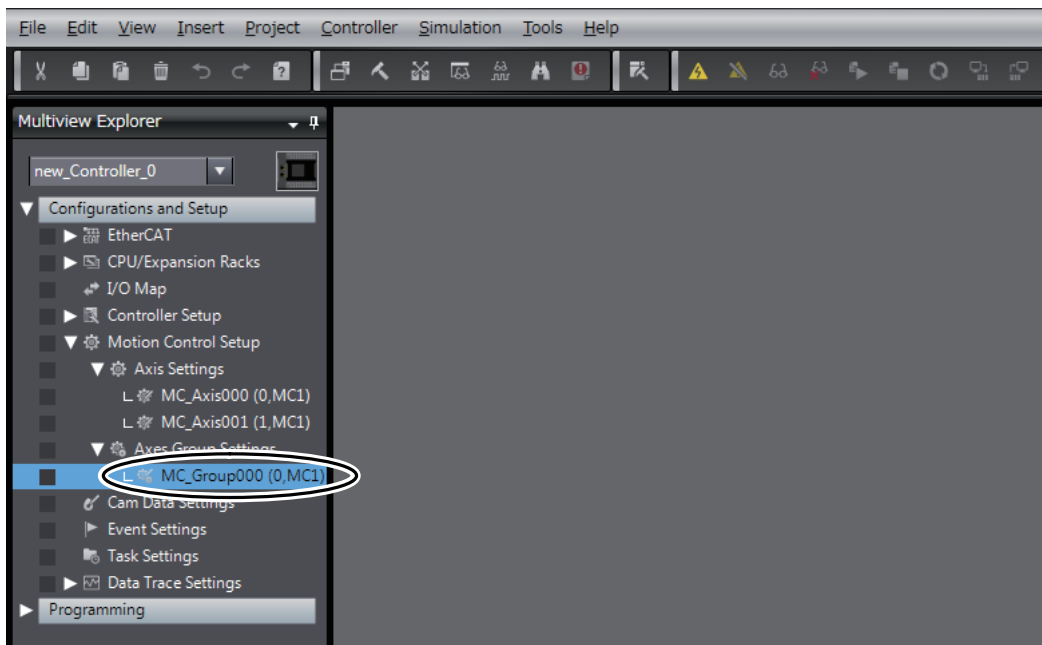

2 Right-click the group that you added in the Multiview Explorer and select **Edit** from the menu.

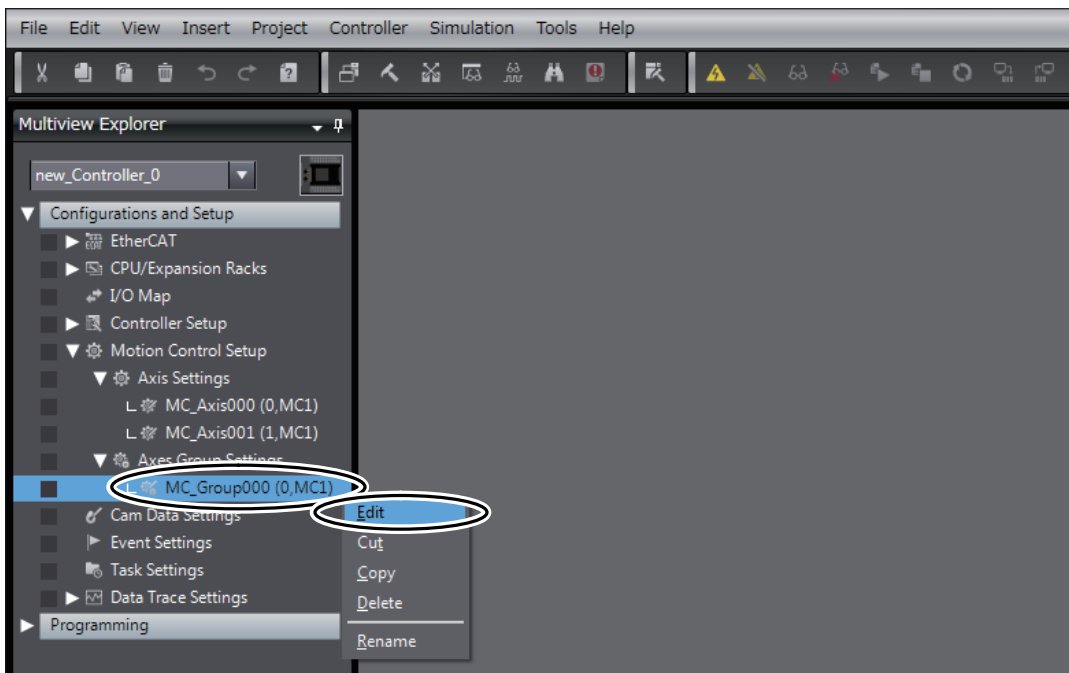

The axes group settings are displayed on the Axes Group Basic Settings Display in the Edit Pane.

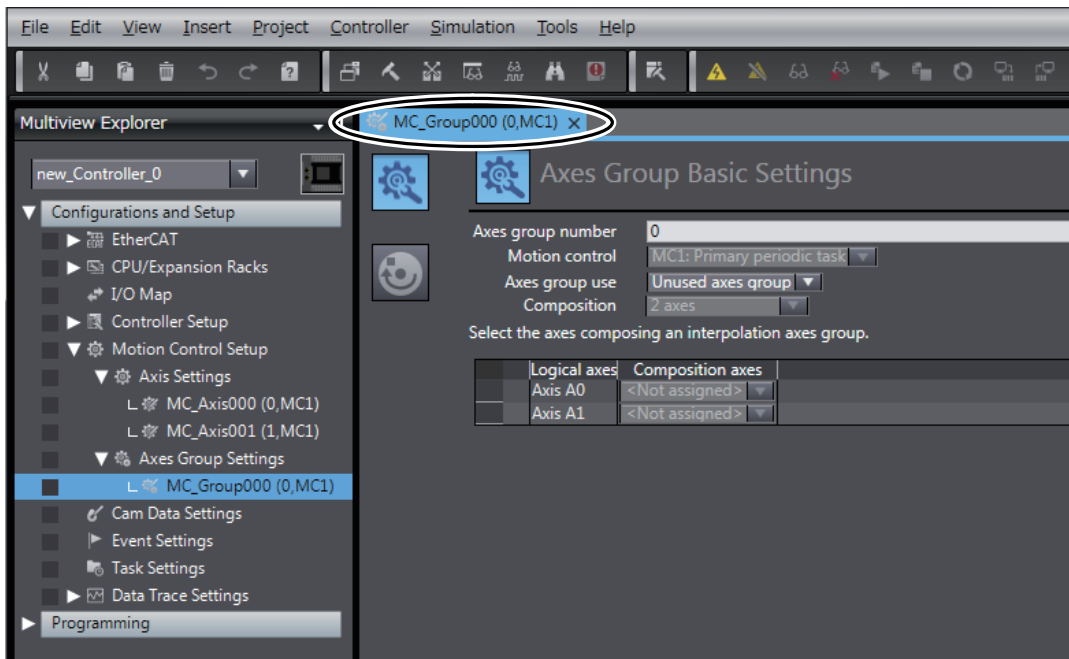

- 3** Set the Axes Group Basic Settings for axes group 0 as shown in the following figure.

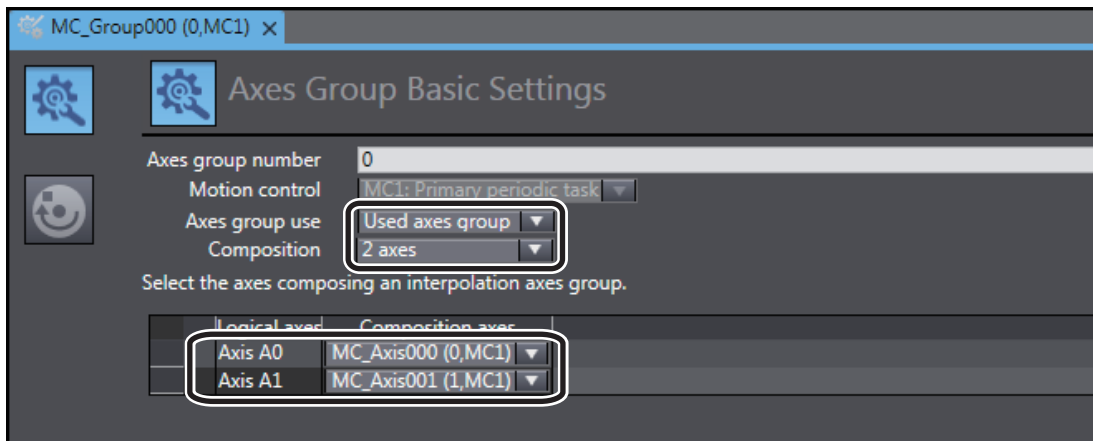

This concludes the axes group settings.

● **Confirming That the Axes Group Variable Is Registered**

System-defined variables for axes groups are called Axes Group Variables.

You can use axes group variables in the user program to enable the execution of axes group motion control instructions or to access the status of the axes groups.

When axes group settings are added, an axes group variable is automatically added to the global variable table.

Use the following procedure to check axes group variables.

- 1 Right-click **Global Variables** under **Programming - Data** in the Multiview Explorer and select **Edit** from the menu.

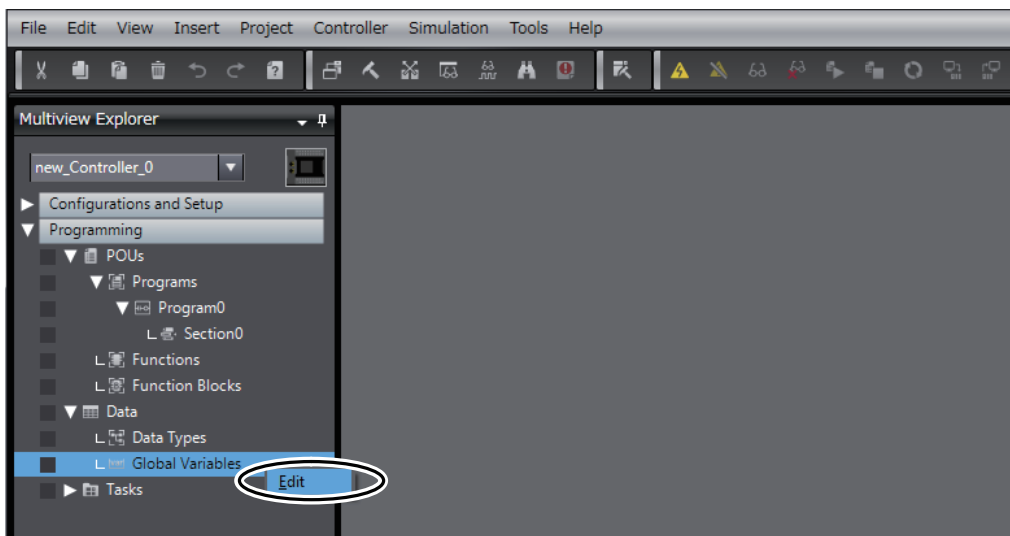

The global variable table where the *MC_Group000* axes group variable was registered is displayed in the Edit Pane.

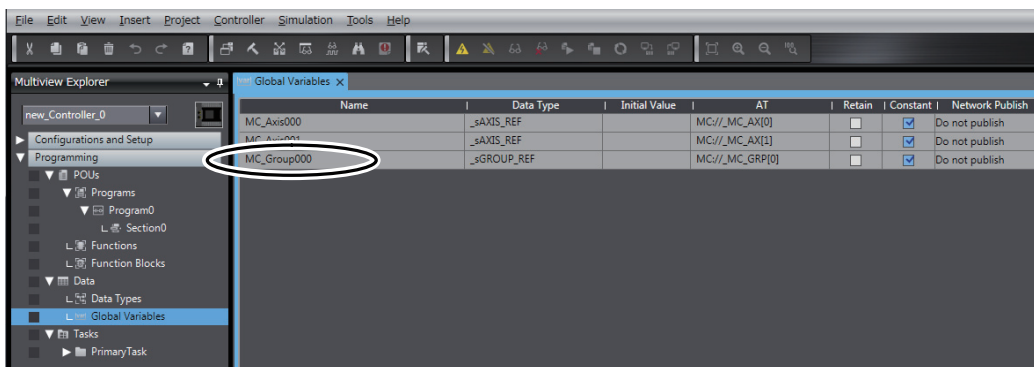

4-3-4 Adding Instructions and Checking the Program

Instructions to perform linear interpolation of the Servo Drives for two axes is added to the program that was created in *Section 3 Setting Up a Single-axis Servo System*, and then the program is checked.

The following instructions are added. To do so, we will use axis variables, an axes group variable, and motion control instructions.

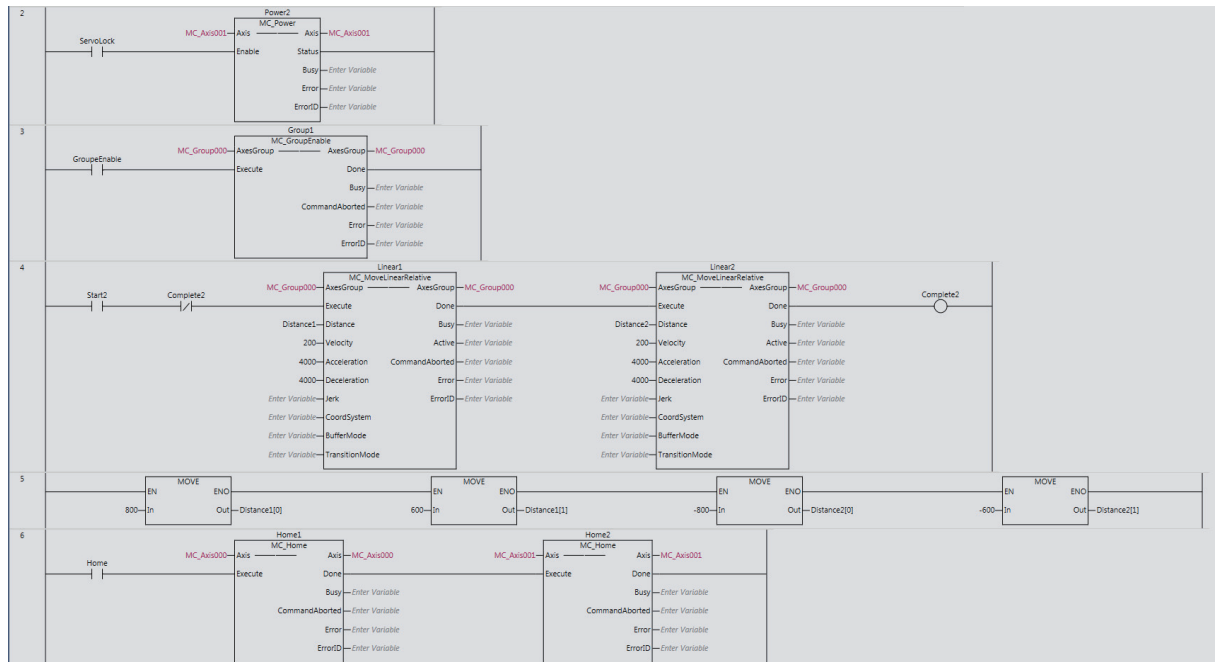

Refer to the *NJ/NX-series Startup Guide for CPU Units* (Cat. No. W513) for details on how to create ladder diagrams.



Precautions for Correct Use

The sample programming that is provided in this Guide includes only the programming that is required to operate the Servomotors. When programming actual applications, also program EtherCAT communications, device interlocks, I/O with other devices, and other control procedures.

Adding Instructions

Add the instructions that control linear interpolation of the Servo Drives for two axes.

● Opening the Ladder Editor

To enter the program, you must start the Ladder Editor and open section 0 of program 0.

- 1 Right-click **Section0** under **Programming – POU's – Programs – Program0** in the Multiview Explorer, and select **Edit** from the menu.

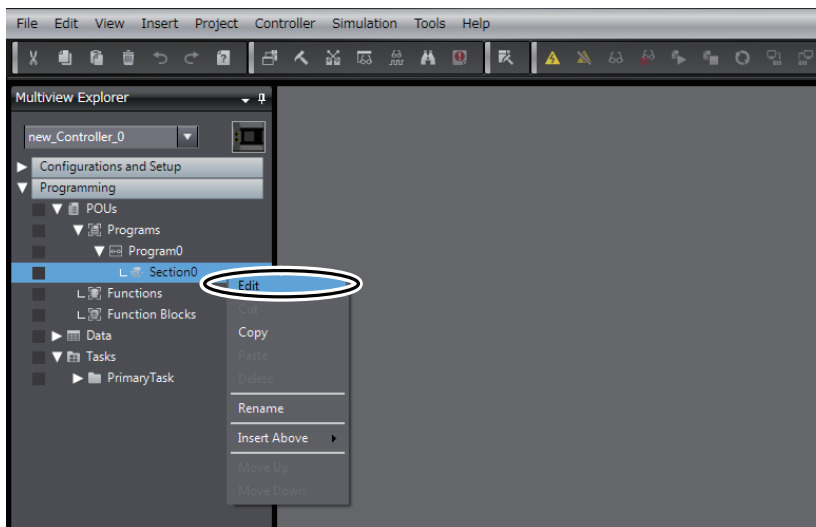

The local variable table and Ladder Editor are displayed in the Edit Pane. From here, you can register local variables and create a ladder diagram.

At this point, the program created in *Section 3 Setting Up a Single-axis Servo System* is displayed.

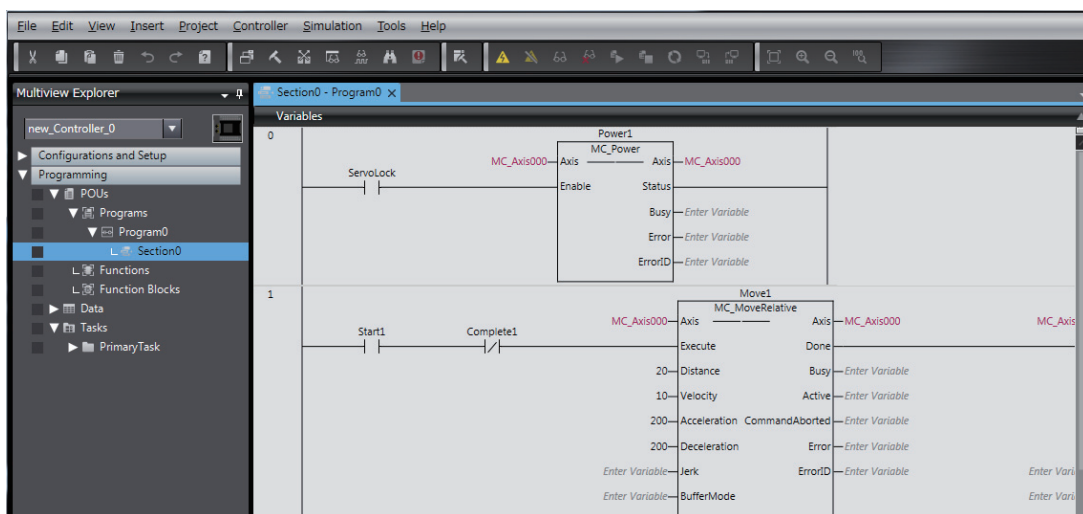

● **Creating the Instructions That Turn the Servo ON and OFF**

You must create the instructions that turn ON the Servo for the Servo Drive for axis 1 in the same way as you did for axis 0.

- 1** Create the following instructions to control turning the Servo ON and OFF for axis 1 (the axis that you added in this section).

The screenshot shows the 'Variables' window with the following table:

Internals	Name	Data Type	Initial Value	AT	Retain	Constant	Comment
Externals	Linear2	MC_MoveLinearRelative					
	Power2	MC_Power					
	Group1	MC_GroupEnable					

The ladder logic shows three rungs:

- Rung 0:** A normally open contact labeled 'ServoLock' is connected to an 'MC_Power' instruction for 'MC_Axis000'. The instruction has 'Enable' and 'Status' inputs, and 'Busy', 'Error', and 'ErrorID' outputs.
- Rung 1:** A normally open contact labeled 'Start1' is connected to an 'MC_Power' instruction for 'MC_Axis001'. This instruction is annotated with callout 'b'.
- Rung 2:** A normally open contact labeled 'ServoLock' is connected to an 'MC_Power' instruction for 'MC_Axis001'. This instruction is annotated with callout 'a'.

Callout boxes provide the following instructions:

- a.** Enter an input for the *ServoLock* variable to control turning the Servo ON and OFF.
- b.** Insert an *MC_Power* (Power Servo) instruction.
- c.** Enter *Power2* as the instance name.
- d.** Enter *MC_Axis001* (the axis variable of axis 1) for the in-out variable.

● **Creating the Instructions That Enable the Axes Group**

To perform linear interpolation for an axes group, the axis group must be enabled. Use the MC_GroupEnable (Enable Axes Group) instruction to enable the axes group.

1 Create the following instructions to enable the axes group.

Internals	Name	Data Type	Initial Value	AT	Retain	Constant	Comment
Externals	Complete1	BOOL			<input type="checkbox"/>	<input type="checkbox"/>	
	Move1	MC_MoveRelative			<input type="checkbox"/>	<input type="checkbox"/>	
	GroupeEnable	BOOL			<input type="checkbox"/>	<input type="checkbox"/>	
	Start2	BOOL			<input type="checkbox"/>	<input type="checkbox"/>	
	Linear1	MC_MoveLinearRelative			<input type="checkbox"/>	<input type="checkbox"/>	

a. Enter an input with the *GroupEnable* variable to perform the homing operations and enable the axes group.

b. Insert the MC_GroupEnable (Enable Axes Group) instruction. Use *Group1* as the instance name and the *MC_Group000* Axes Group Variable as the in-out variable.



Additional Information

Cascade connections are possible for Ladder Diagram Instructions (e.g., LD (Load) and AND (AND)), for FB instructions (e.g., MC_MoveRelative (Relative Positioning)), and for FUN instructions (e.g., MOVE (Move)).

● **Creating the Instructions That Perform Linear Interpolation**

Here, the MC_MoveLinearRelative (Relative Linear Interpolation) instruction is used to perform linear interpolation. We will use two instances of this instruction to repeatedly perform linear interpolation.

- 1** Create the following instructions to repeatedly perform round-trip operation with linear interpolation.

Enter the values that are given in the following table for the input variables for the two instances of the MC_MoveLinearRelative (Relative Linear Interpolation) instruction. The values of the *Distance* input variables are set with the instructions that are entered in the next procedure.

Input variable	Meaning	Set value	
		Linear1	Linear2
Distance	Travel Distance (mm)	Distance1	Distance2
Velocity	Target Velocity (mm/s)	200	200
Acceleration	Acceleration Rate (mm/s ²)	4000	4000
Deceleration	Deceleration Rate (mm/s ²)	4000	4000

a. Enter inputs for the *Start2* and *Completed2* variables to control linear interpolation.

b-1. Insert two MC_MoveLinearRelative (Relative Linear Interpolation) instructions.

b-2. Use Linear1 and Linear2 as the instance names, and use the *MC_Group000* Axes Group Variable as the in-out variables in both instructions.

c. Enter an output for the *Complete2* variable to turn ON when the round-trip operation is completed.

The screenshot shows a variable declaration table with columns: Name, Data Type, Initial Value, AT, Retain, Constant, Comment. Variables include Start2 (BOOL), Linear1 and Linear2 (MC_MoveLinearRelative), Distance1 and Distance2 (ARRAY[0..3] OF LREAL). Below, a ladder logic diagram shows two MC_MoveLinearRelative instructions. The first instruction (Linear1) has inputs: MC_Group000 (AxesGroup), Distance1 (Distance), 200 (Velocity), 4000 (Acceleration), 4000 (Deceleration), Jerk, CoordSystem, BufferMode, and TransitionMode. Its outputs are Done, Busy, Active, CommandAborted, Error, and ErrorID. The second instruction (Linear2) has similar inputs and outputs. A normally open contact labeled 'Complete2' is connected to the Done output of the second instruction.

● **Creating the Instructions to Set the Travel Distances**

Values must be set for the *Distance* input variables to specify the travel distances for the MC_MoveLinearRelative (Relative Linear Interpolation) instructions. A user-defined array variable is used to set the values for the *Distance* variables.

- 1 Create the following instructions to set the travel distances for the linear interpolation operations.

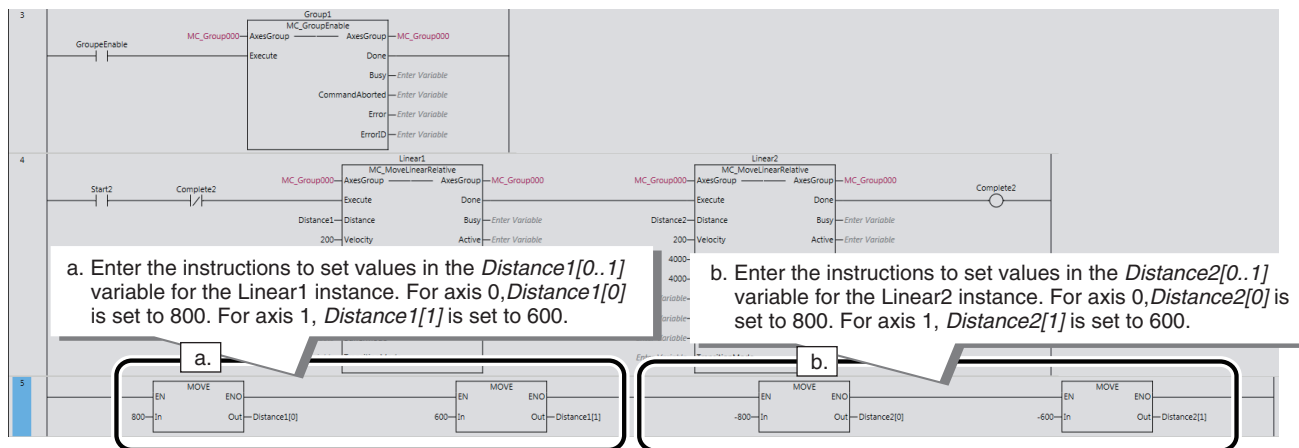

● **How to set for the *Distance* variables**

Because the MC_MoveLinearRelative (Relative Linear Interpolation) instruction performs linear interpolation for up to 4 axes, the data type of the *Distance* variable (Travel Distance) is ARRAY[0..3] OF LREAL.

This is an array that enables four real numbers to be set. The array is expressed by *Distance1[n]*, n = subscript.

As two axes are used for this program, the values shown below are set in *Distance 1* and *Distance 2* for axis 0 and axis 1.

			Distance1	
Linear1	Axis 0	[0]	800	
	Axis 1	[1]	600	
	Not set	[2]	---	
	Not set	[3]	---	

			Distance2	
Linear2	Axis 0	[0]	-800	
	Axis 1	[1]	-600	
	Not set	[2]	---	
	Not set	[3]	---	

Checking the Program

Check the program that you created.
If there are any errors, correct them.

1 Execute *Check All Programs*.

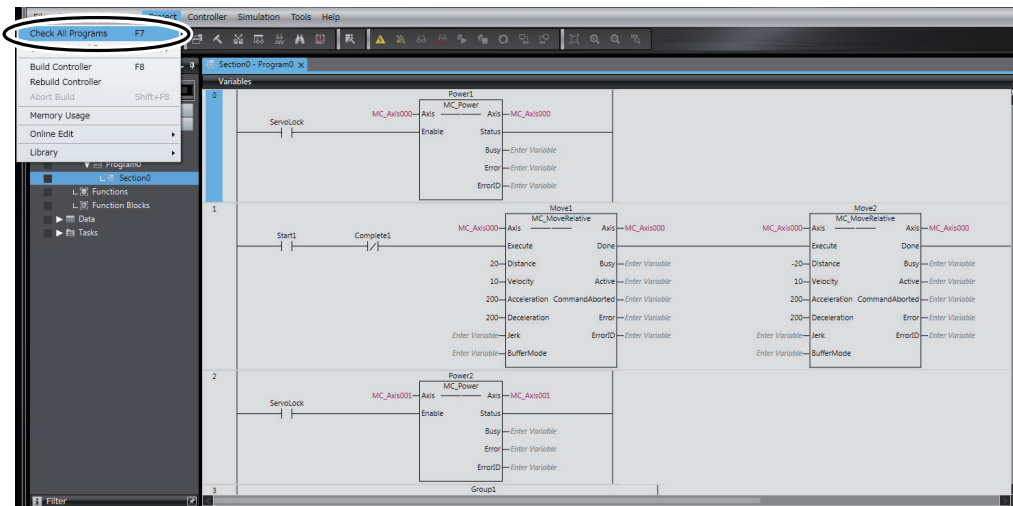

The results of the program check are displayed on the Build Tab Page.
If there are any errors, correct them.

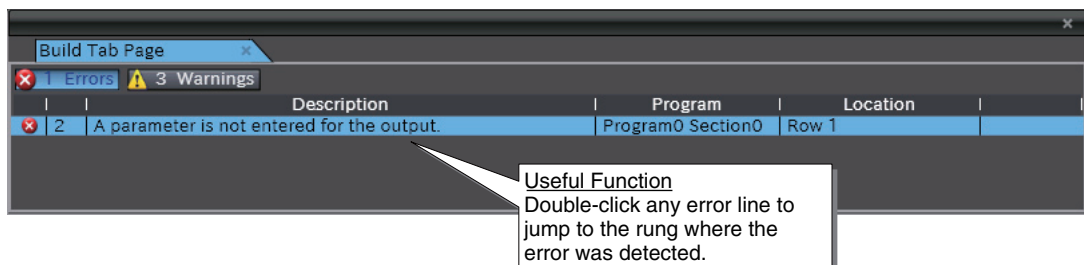

4-3-5 Transferring the Project to the CPU Unit

Use the procedure described in 3-6 *Transferring the Project to the CPU Unit* to transfer the corrected project to the CPU Unit.

Remain in PROGRAM mode at this time.

4-4 Confirming System Operation

Confirm that the system is operating correctly.

Place the CPU Unit online with the Sysmac Studio before you perform the procedures that are given in this section.

4-4-1 Checking the New Axis 1

Before you check the operation of the program, you will check the new axis 1. Use the procedures in *3-7-1 Checking for Controller Errors* and *3-7-3 Checking the Servo Drive Wiring* to check the new axis 1. Axis 1 is checked in PROGRAM mode to prevent a user program for which operation has not been verified from affecting the confirmation results.

4-4-2 Checking Program Operation

You will change the operating mode of the CPU Unit to RUN mode and then use monitoring, control BOOL variables (set/reset), and use the MC Monitor Table in the Ladder Editor to check the operation of the program that you created. Control (set/reset) the status of the inputs to control the motion control instructions, and use the MC Monitor Table to check the results of their execution.

- 1 Double-click **Section0** under **Programming - POUs - Programs - Program0** in the Multiview Explorer.

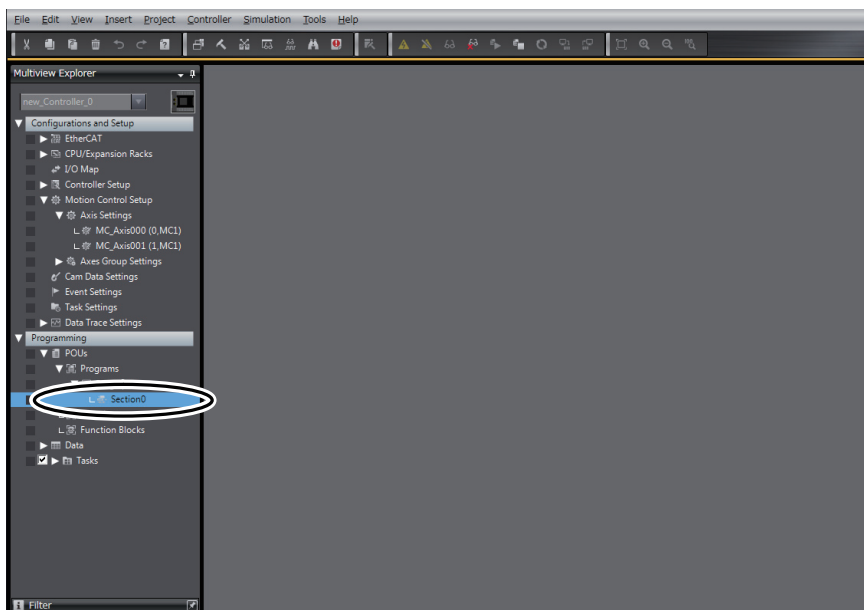

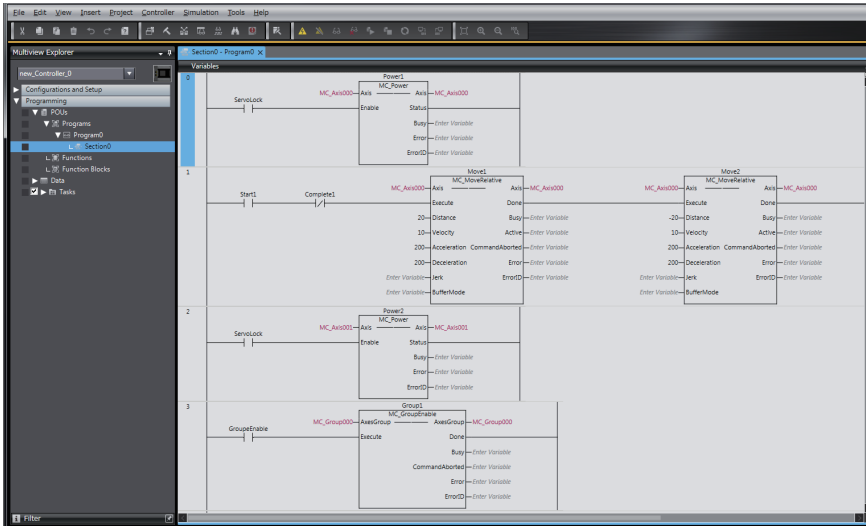

The ladder program is displayed in the monitored state in the Edit Pane.



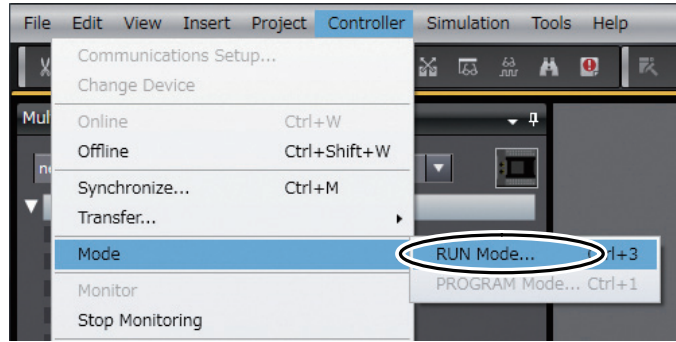

2 Use one of the following methods to change the operating mode to RUN mode.

Method 1: Select **Mode – RUN Mode** from the Controller Menu.



Method 2: Click the  Button on the Toolbar.



Method 3: Press the  **Ctrl +**  **3** Keys.

3 The following dialog box is displayed. Confirm that no problem will occur even if you change the operating mode, and then click the **Yes** Button.

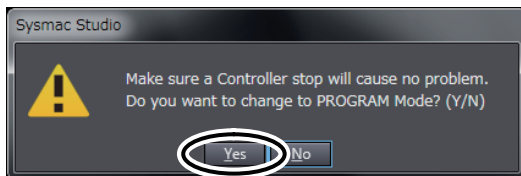

- Right-click *ServoLock* in the program in the Edit Pane, and then select **Set/Reset - Set** from the menu.



ServoLock changes to TRUE, and *Power1* and *Power2* are executed.

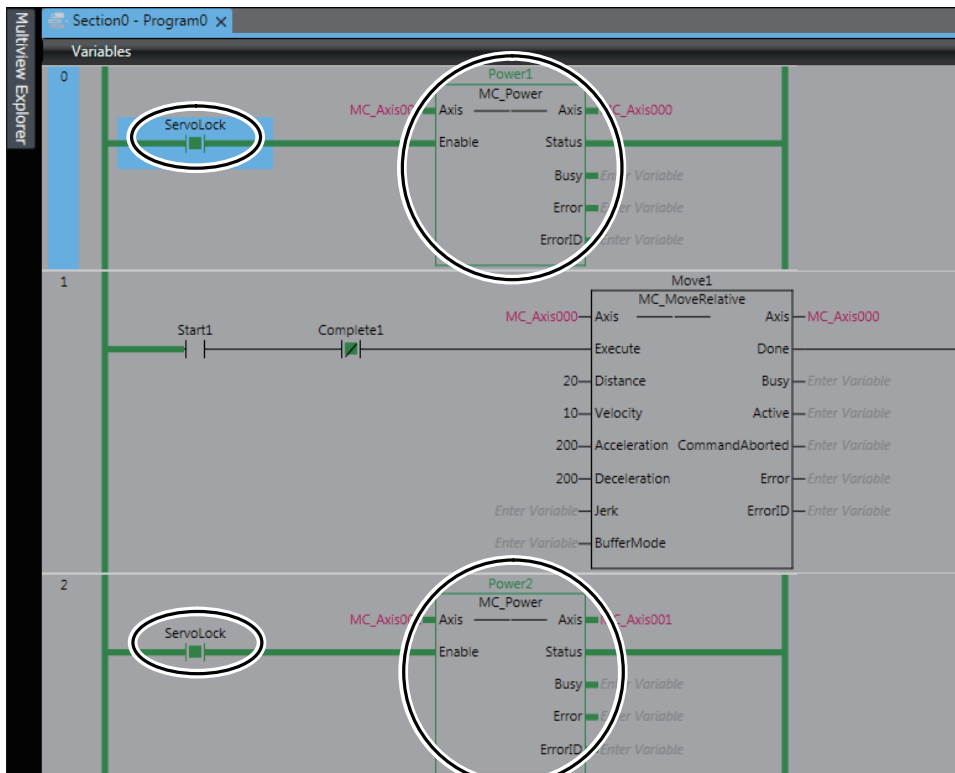

- 5 Right-click *GroupEnable* in the program in the Edit Pane, and then select **Set/Reset - Set** from the menu.

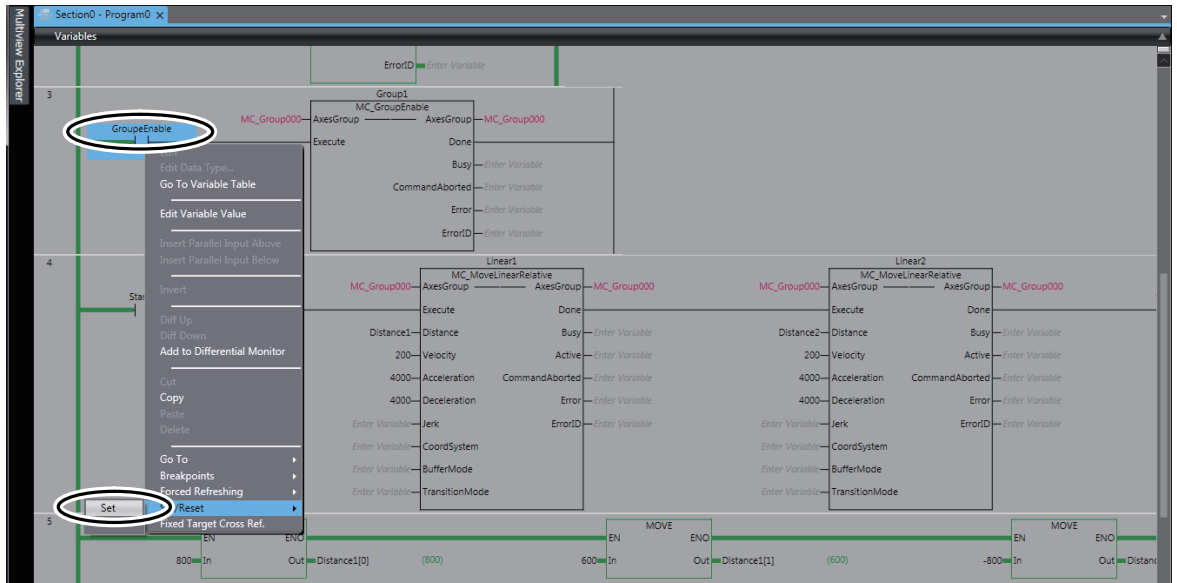

GroupEnable changes to TRUE, and *Group1* is executed.

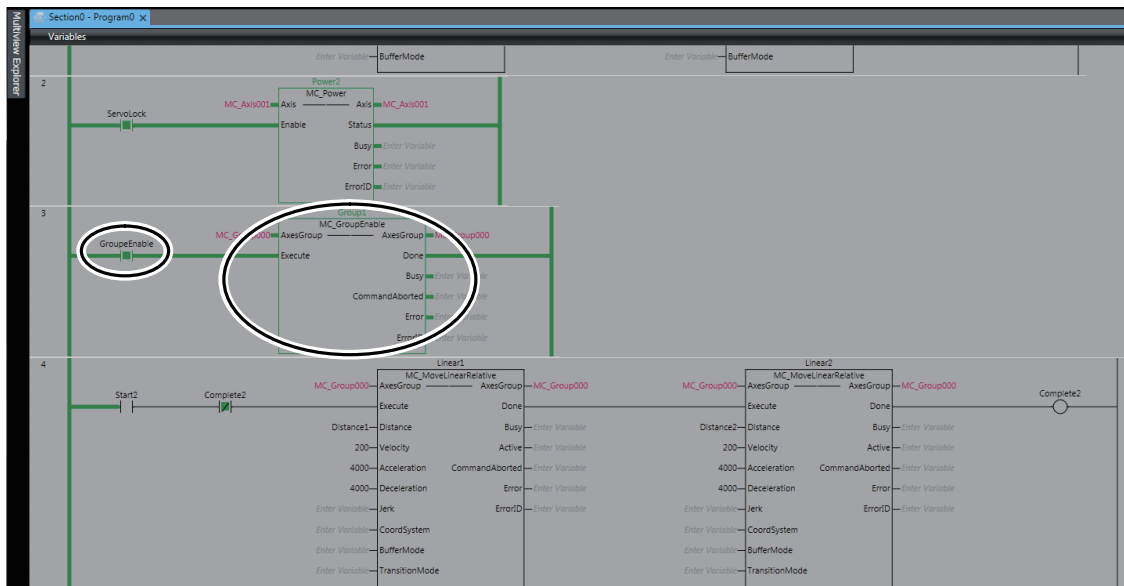

- 6 Right-click *Start2* in the program in the Edit Pane, and then select **Set/Reset - Set** from the menu.

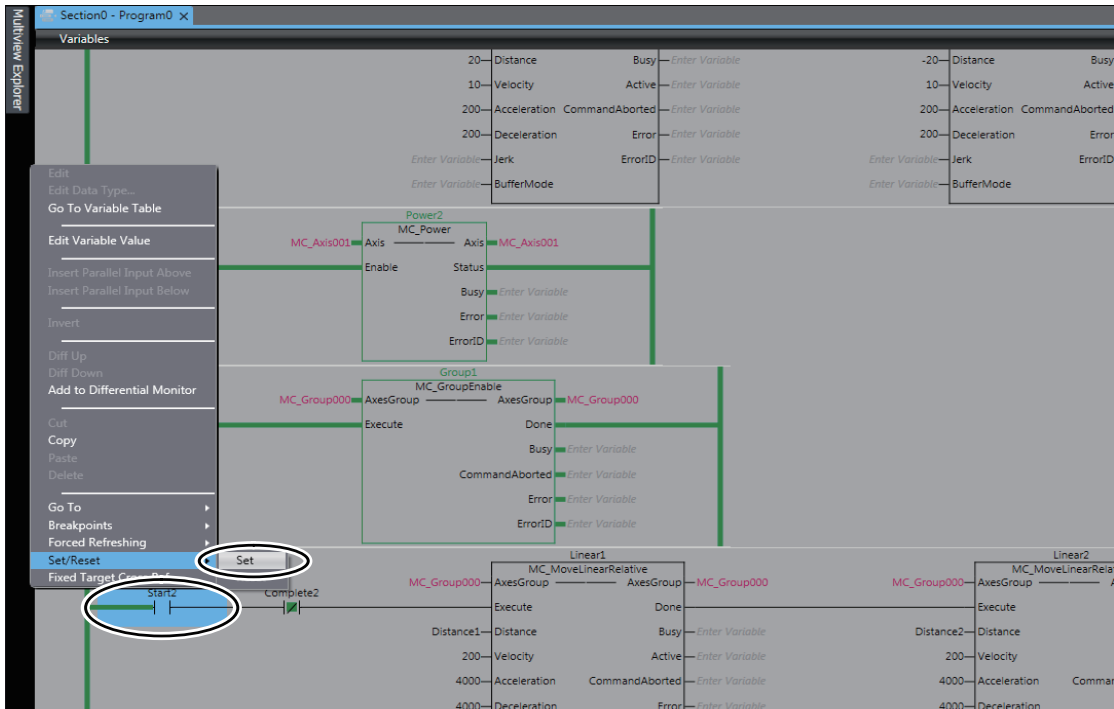

Start2 changes to TRUE.

Linear1 is executed and positioning is started. When the positioning for *Linear1* is completed, *Linear1* execution stops and *Linear2* is executed. This operation is repeated.

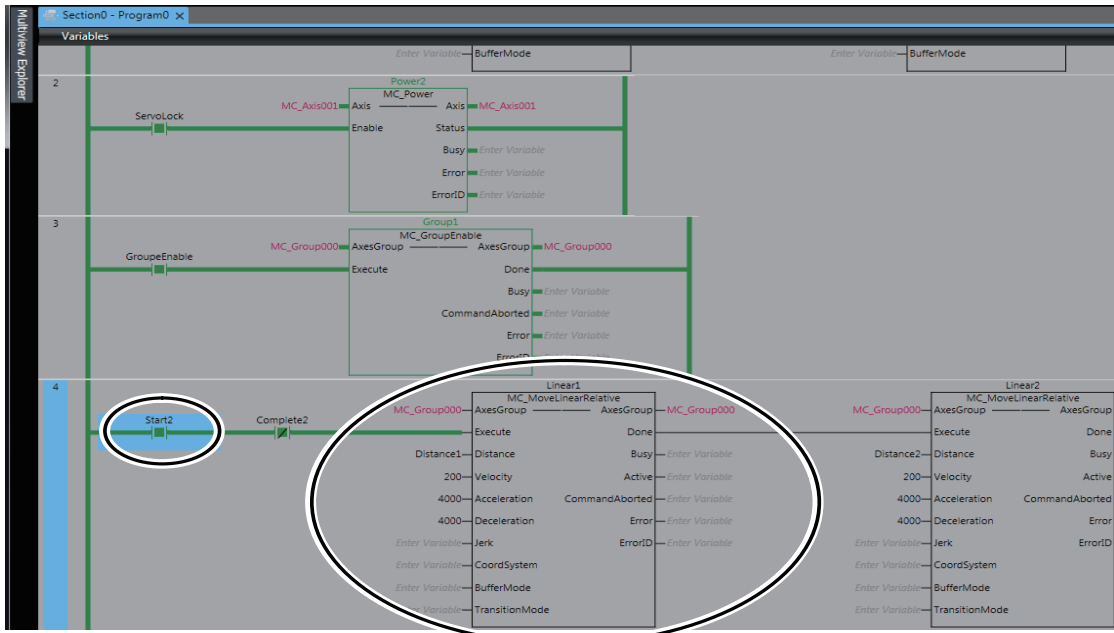

- 7 Right-click **Axis Settings** under **Configurations and Setup - Motion Control Setup** in the Multiview Explorer, and select **MC Monitor Table** from the menu.

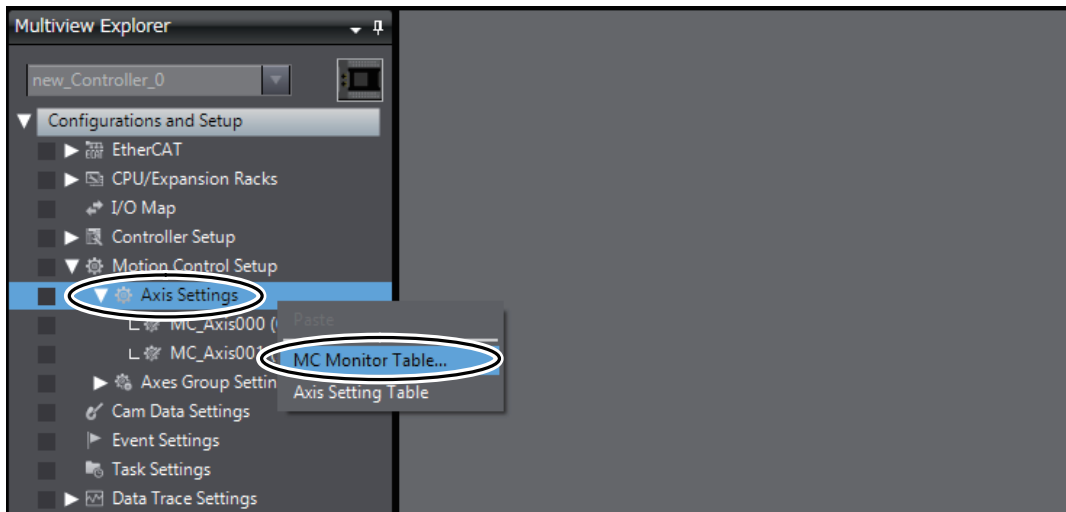

The MC Monitor Table is displayed in the Edit Pane.

MC Monitor Table x			
Axis Name	1 MC_Axis000(0)	2 MC_Axis001(1)	
Disabled	0	0	
Standstill	0	0	
Discrete	0	0	
Continuous	0	0	
Synchronized	0	0	
Homing	0	0	
Stopping	0	0	
ErrorStop	0	0	
Coordinated	1	1	
▼ Details			
Idle	0	0	
InPosWaiting	0	0	
Homed	1	1	
InHome	0	0	
Vellimit	0	0	
▼ Dir			
Posi	1	1	
Nega	0	0	
▼ DrvStatus			
ServoOn	1	1	
Ready	1	1	
MainPower	1	1	
P_OT	0	0	
N_OT	0	0	
HomeSw	0	0	
Home	0	0	
ImdStop	0	0	
Latch1	0	0	
Latch2	0	0	
DrvAlarm	0	0	
DrvWarning	0	0	
ILA	0	0	
CSP	1	1	
CSV	0	0	
CST	0	0	
▼ Cmd			
Pos	259.04 mm	194.28 mm	
Vel	159.999999999997 mm/sec	120.000000000005 mm/sec	
Trq	0	0	
▼ Act			
Pos	258.719999790192 mm	194.039999246597 mm	
Vel	160.000324249268 mm/sec	119.999647140503 mm/sec	
Trq	0	0	
TimeStamp	0	0	
▼ MFaultLvl			
Active	0	0	
Code	0	0	
▼ Obsr			
Active	0	0	
Code	0	0	

8 Use the MC Monitor Table to confirm that the axis 0 and axis 1 are moving. *a* and *b* in the following figure show the information you need to check.

- a: Check that the value of *Pos* under *Cmd* is either increasing or decreasing.
- b: Check that the value of *Pos* under *Act* is either increasing or decreasing.

MC Monitor Table x			
Axis Name	1 MC_Axis000(0)	2 MC_Axis001(1)	
Disabled	0	0	
Standstill	0	0	
Discrete	0	0	
Continuous	0	0	
Synchronized	0	0	
Homing	0	0	
Stopping	0	0	
ErrorStop	0	0	
Coordinated	1	1	
▼ Details			
Idle	0	0	
InPosWaiting	0	0	
Homed	1	1	
InHome	0	0	
VelLimit	0	0	
▼ Dir			
Posi	1	1	
Nega	0	0	
▼ DrvStatus			
ServoOn	1	1	
Ready	1	1	
MainPower	1	1	
P_OT	0	0	
N_OT	0	0	
HomeSw	0	0	
Home	0	0	
ImdStop	0	0	
Latch1	0	0	
Latch2	0	0	
DrvAlarm	0	0	
DrvWarning	0	0	
ILA	0	0	
CSP	1	1	
CSV	0	0	
CST	0	0	
▼ Cmd			
Pos	259.04 mm	194.28 mm	} a
Vel	159.999999999997 mm/sec	120.000000000005 mm/sec	
Trq	0	0	
▼ Act			
Pos	258.719999790192 mm	194.039999246597 mm	} b
Vel	160.000324249268 mm/sec	119.999647140503 mm/sec	
Trq	0	0	
TimeStamp	0	0	
▼ MFaultLvl			
Active	0	0	
Code	0	0	
▼ Obsr			
Active	0	0	
Code	0	0	



Additional Information

- In this program, positioning is performed without using the Home instruction because the 1S-series AC Servo System is equipped standard with an absolute encoder.
- The *Linear1* and *Linear2* instances perform linear interpolation for relative positions from where execution of the *Linear1* instance starts.
To start from 0 mm, execute the *MC_Home* (Home) instruction to define home or execute the *MC_MoveAbsolute* (Absolute Positioning) instruction to move to 0 mm, and then execute the *Linear1* instance.

4-4-3 Using Data Tracing to Check Operation

Use data tracing to check the current operation.

- 1 Double-click **DataTrace0** under **Configurations and Setup – Data Trace Settings** in the Multiview Explorer.

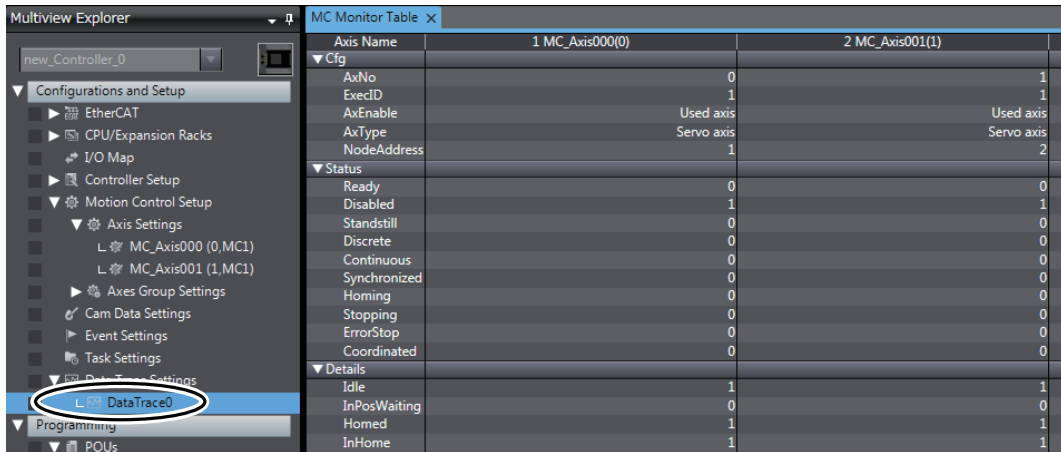

The DataTrace0 Tab Page is displayed in the Edit Pane.

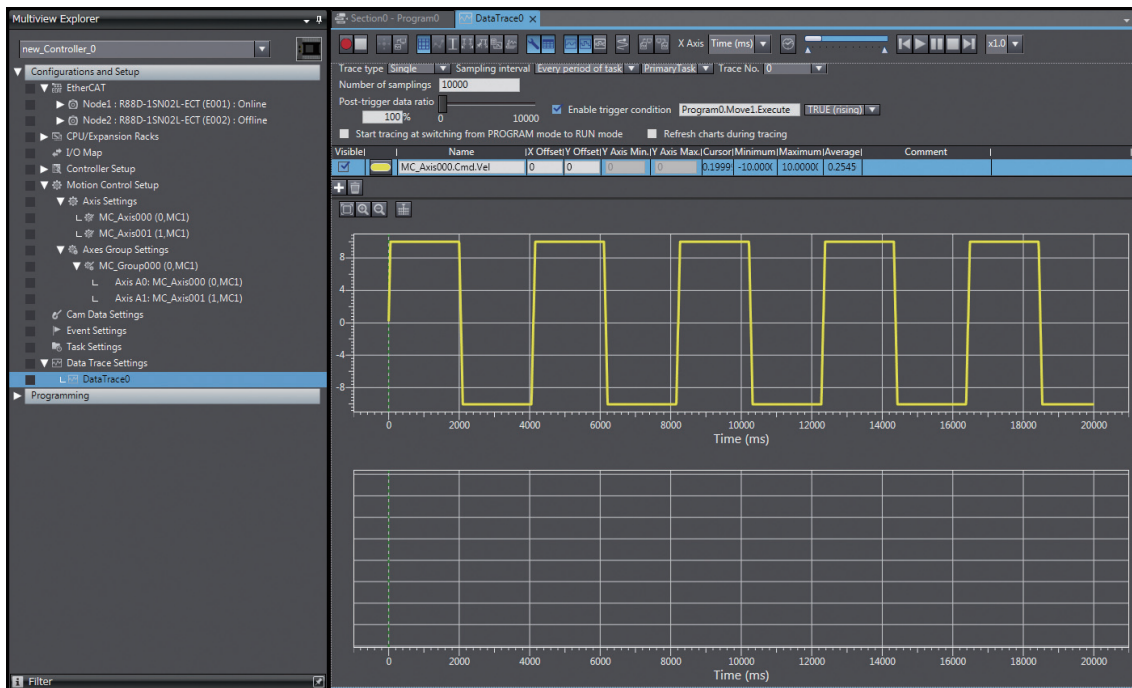

- 2 Select the *Enable trigger condition* Check Box on the DataTrace0 Tab Page and enter the variable to use as the trigger condition. For this example, use *Program0.Linear1.Execute*.

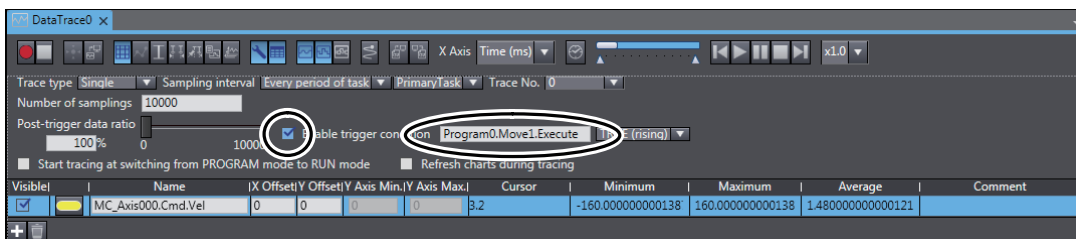

- 3 Click the **Add Target** Button.

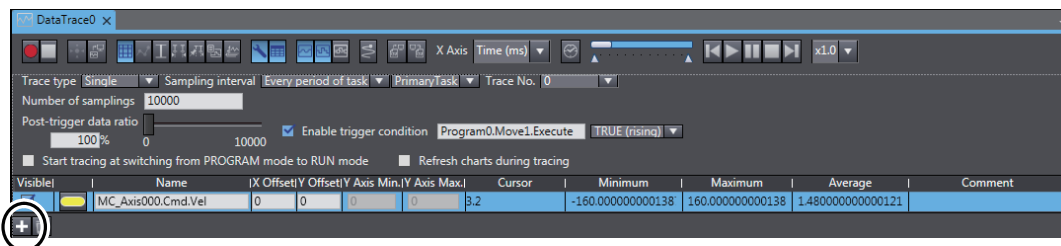

A trace variable line is added to the list.

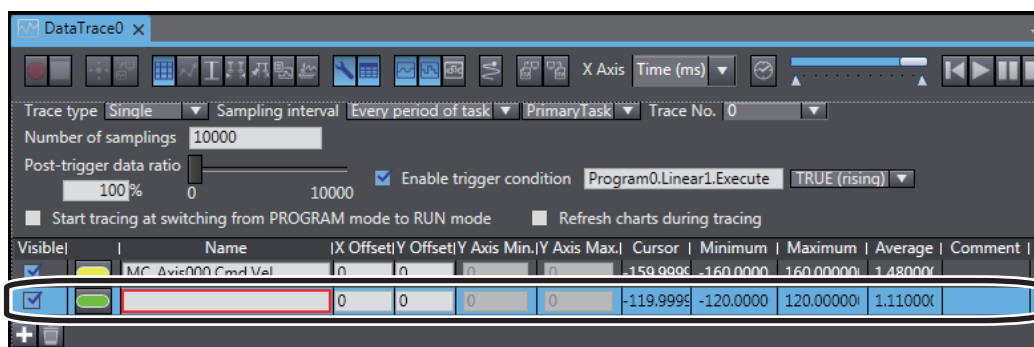

4 Enter *MC_Axis001.Cmd.Vel* for the name of the variable to trace on the new line.

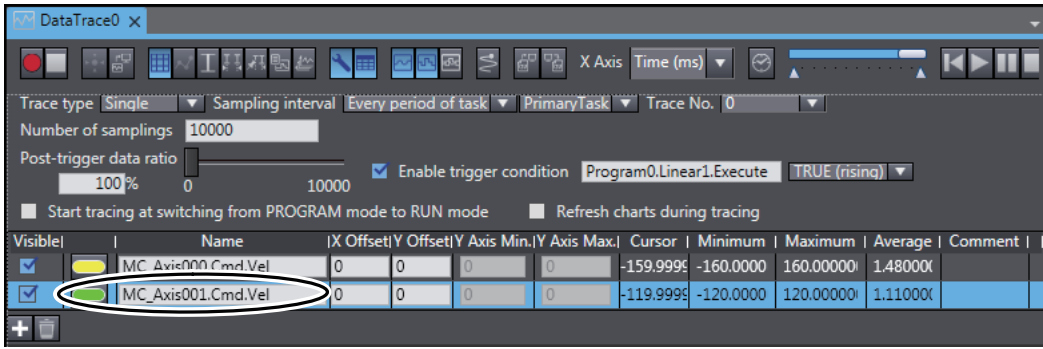

5 Click the **Start Trace Button**.

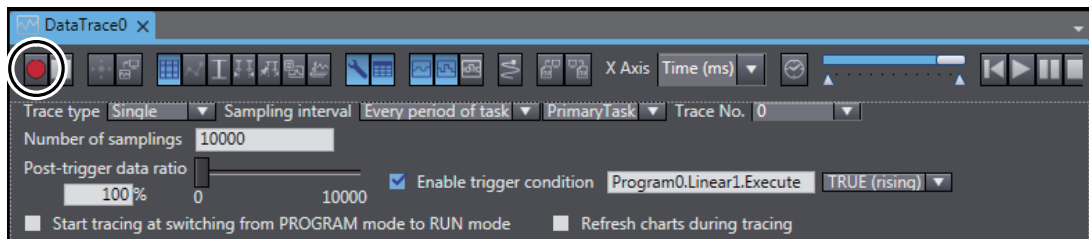

6 Make sure that the status bar at the lower left changes as shown in the following figure.

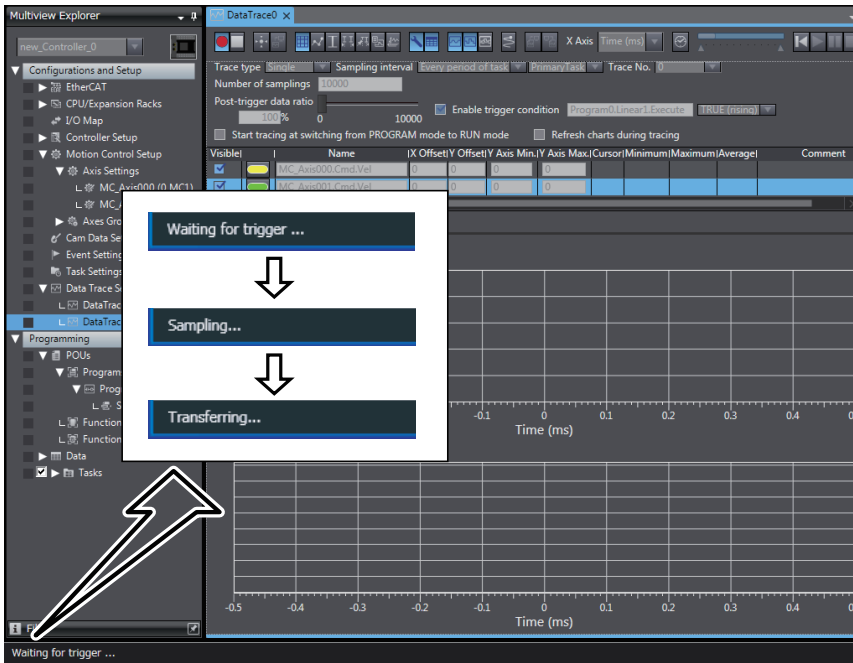

7 Make sure that the results of the data trace are displayed.

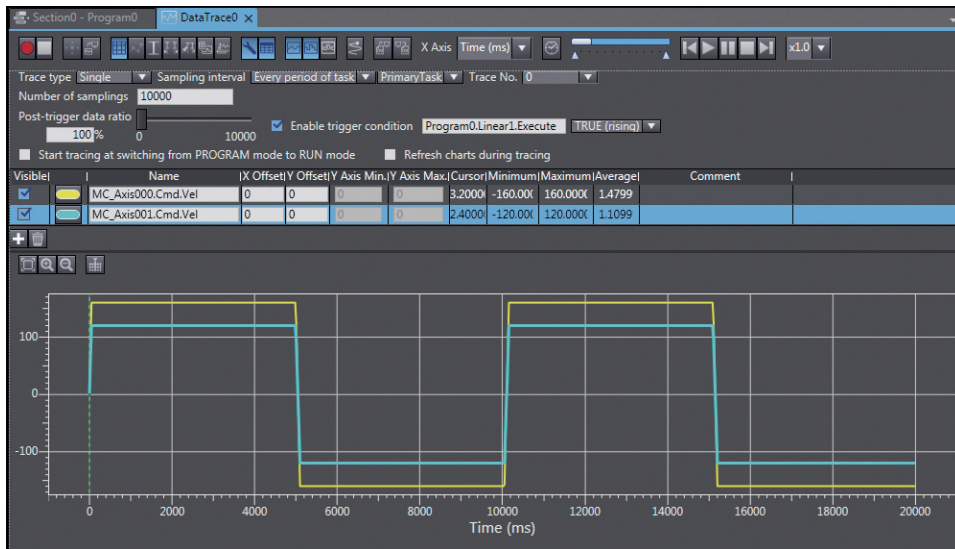

Make sure that the trace results show the same waveform as shown in *4-1 Two-axis Servo System Operation*.



Additional Information

You can use the 3D Motion Trace Display Mode to check program operation. The 3D Motion Trace Display Mode displays the operation of an axes group based on a machine model that assumes an XY stage. This mode allows you to display the trace results in the same coordinate system as the graph that shows the positions of two axes in *4-1 Two-axis Servo System Operation*. Refer to *A-2 Using the 3D Motion Trace Display Mode to Check Operation* for the procedure.

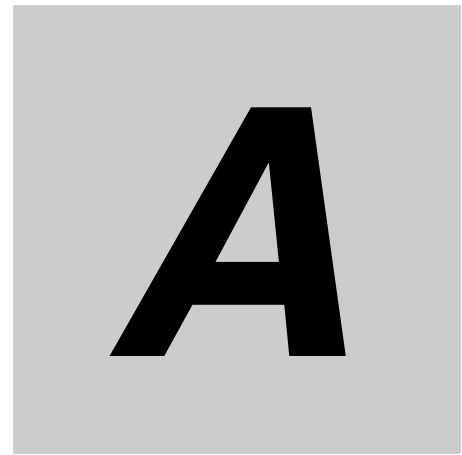

Appendices



A-1 Settings When Control Input Signals Are Not Wired	A-2
A-2 Using the 3D Motion Trace Display Mode to Check Operation	A-7



A-1 Settings When Control Input Signals Are Not Wired

An error will occur in the CPU Unit if the Servo parameters for the Servo Drive are left at their default values when the Servo Drive control input signals are not wired. This is because the CPU Unit stops operation when a drive prohibit or immediate stop signal is detected. The minor fault level Controller errors that occur are as follows:

- Error Stop Input (Event code: 68220000)
- Drive Prohibition Input Error (Event code: 64E30000)

This section describes how to temporarily change the Servo parameters to prevent these errors from occurring in the CPU Unit.

The procedure described here assume that a project with a Servo Drive registered to the EtherCAT network configuration has been transferred to the CPU Unit and that the CPU Unit is currently online.



Precautions for Correct Use

If the control input signals are not wired, it will not be possible to stop operation for limit inputs or immediate stop inputs in the event that unexpected motor operation occurs. Remove the coupling from the motor shaft or take other suitable measures to prevent a hazardous condition from occurring.

Perform the following before you perform the procedures that are given in this section.

- Place the Sysmac Studio online with the CPU Unit.
- Transfer to the CPU Unit the project that contains the EtherCAT network configuration in which the Servo Drives are registered.

- 1 Right-click **Node1: R88D-1SN01L-ECT (E001): Offline** under **Configurations and Setup - EtherCAT** in the Multiview Explorer, and select **Online** from the menu.

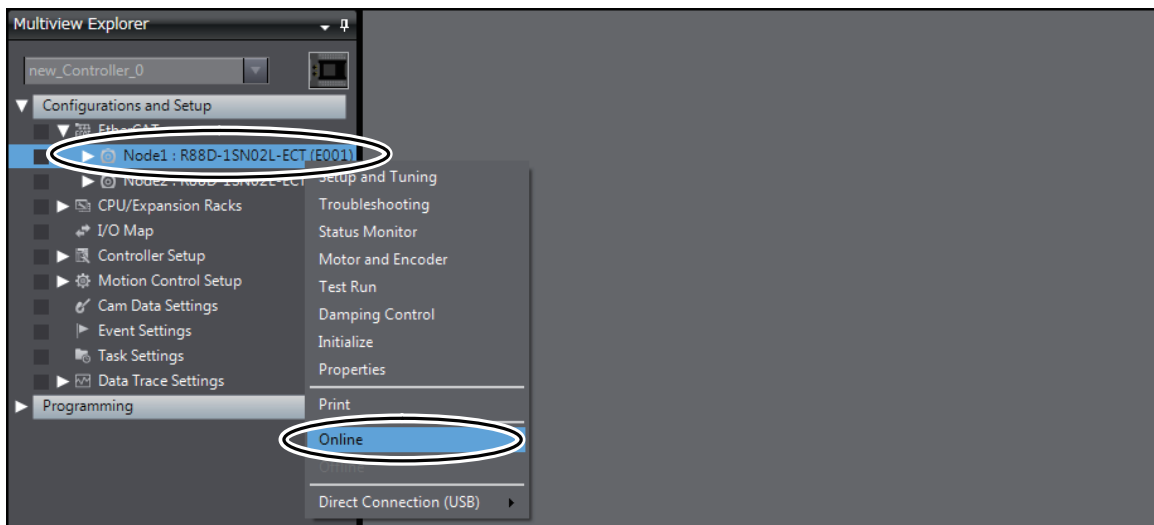

This places *Node1:R88D-1SN01L-ECT(E001)* online.

- 2 Right-click **Node1: R88D-1SN01L-ECT (E001): RUN Mode** under **Configurations and Setup - EtherCAT** in the Multiview Explorer, and select **Setup and Tuning** from the menu.

The Setup and Tuning Portal appears in the Edit Pane.

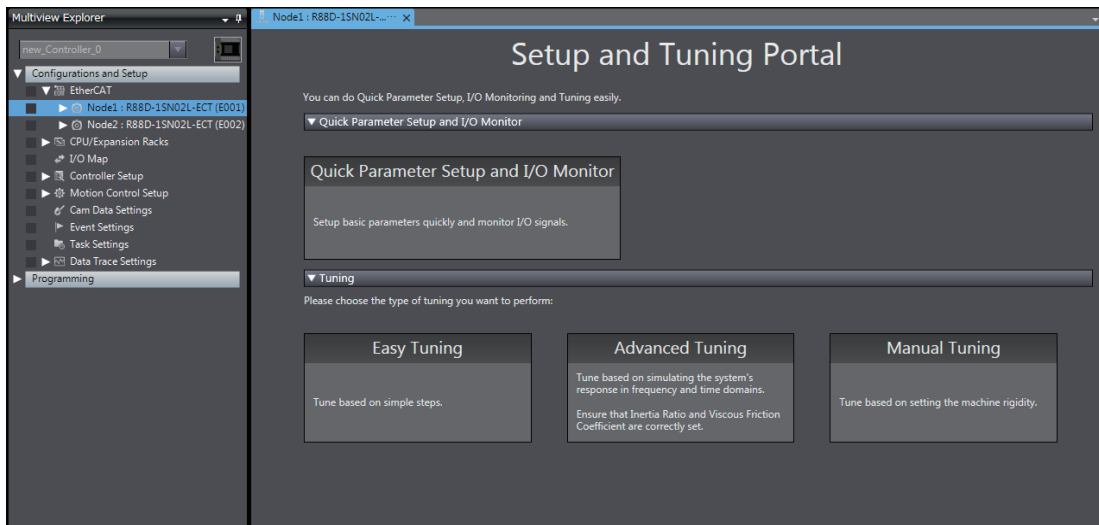

- 3 Click the **Quick Parameter Setup and I/O Monitor** Button.

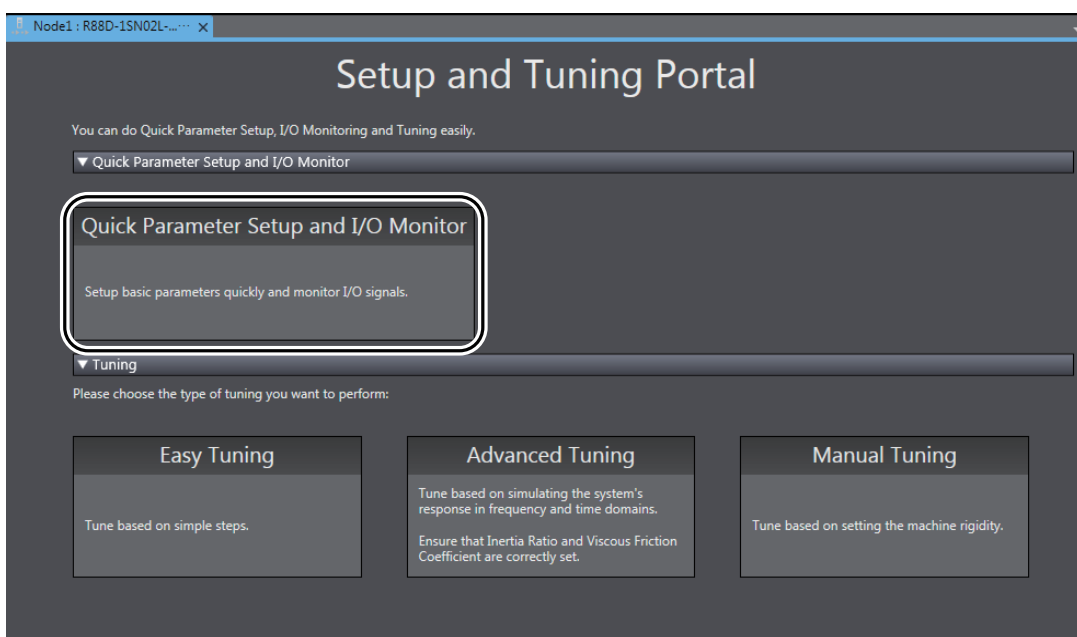

The following dialog box appears. Click the **Yes** Button.

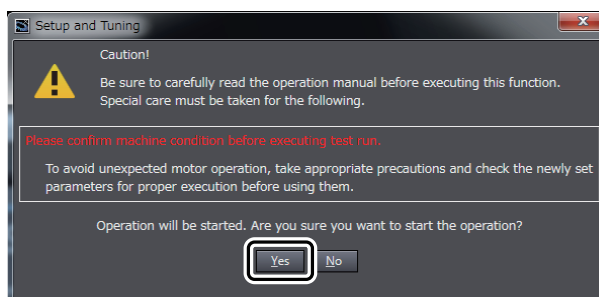

The Motor and Encoder setting Page appears.

4 Click the **Next** Button.

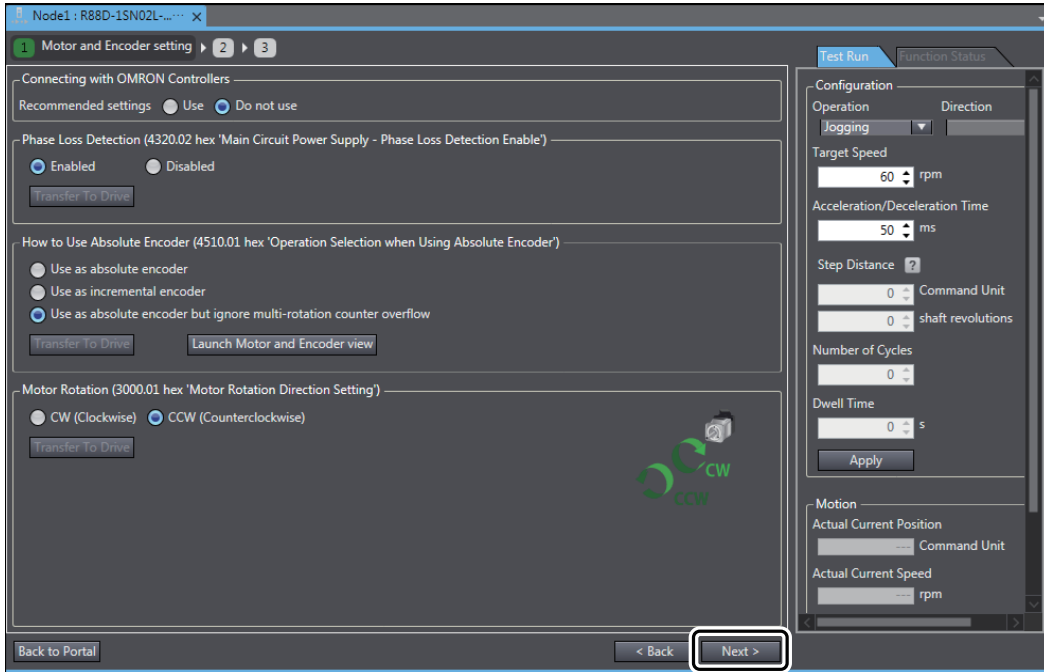

The Input Signals setting Page appears.

5 Change the signal active conditions of the below listed input signals from High to Low, and then click the **Transfer to Drive** Button.

- Error Stop Input
- Positive Drive Prohibit Input
- Negative Drive Prohibit Input

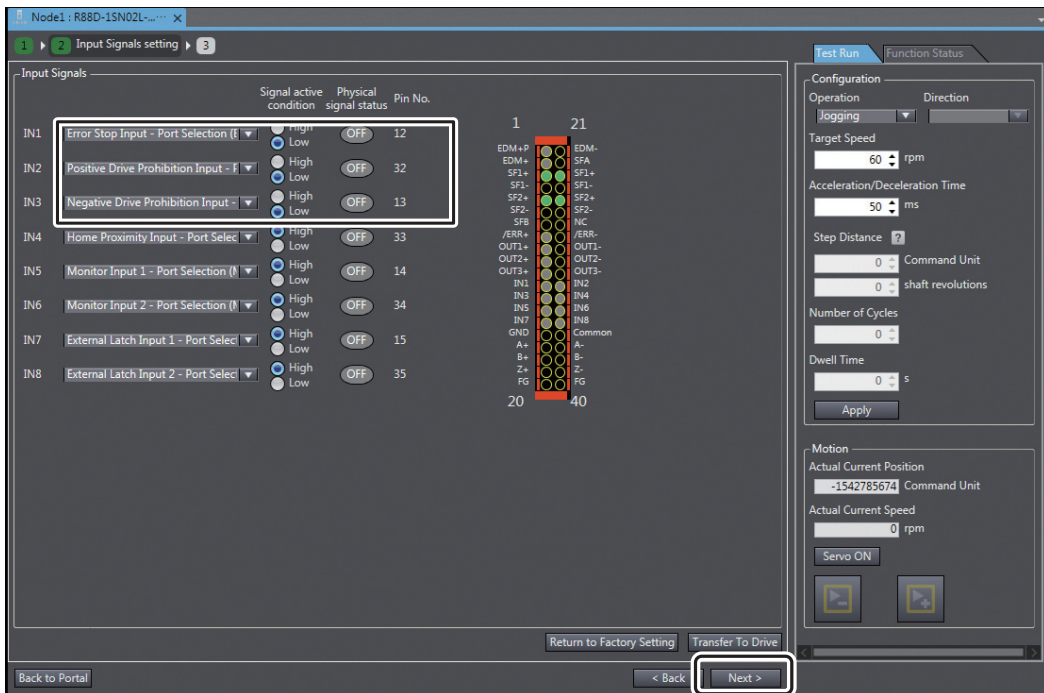

The following dialog box appears. Click the **Yes** Button.

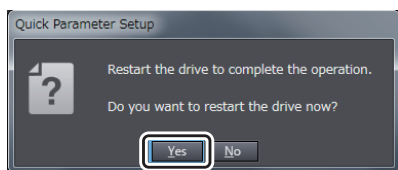

The drive restarts and you return to the Input Signals setting Page.

6 Click the **Next** Button.

The Output Signals setting Page appears.

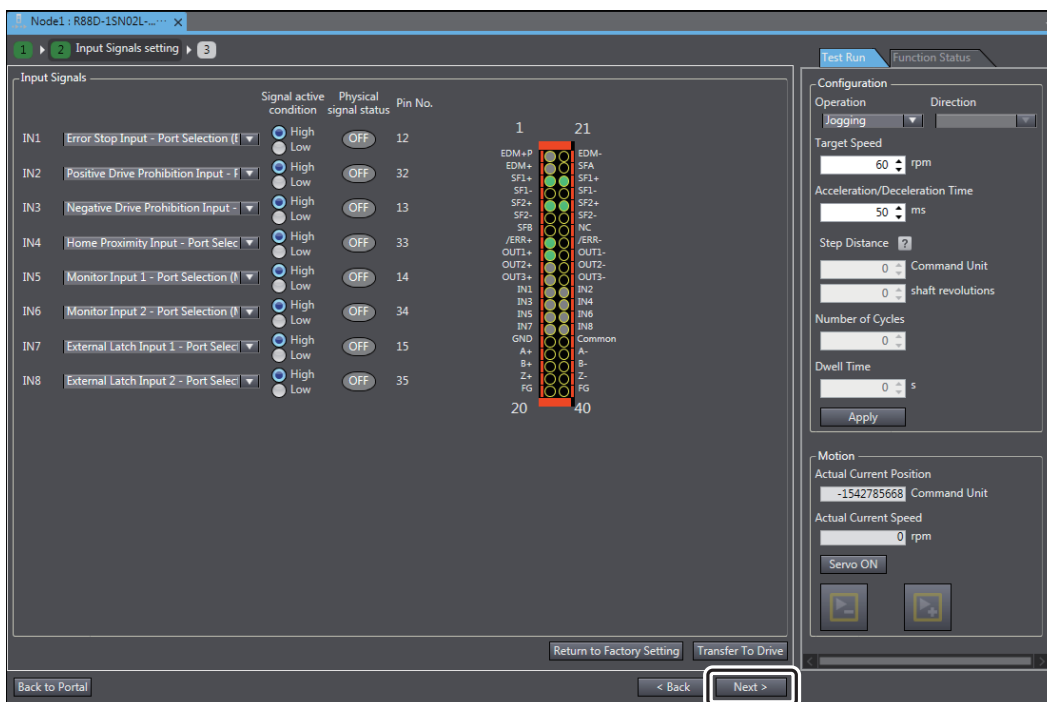

7 Click the **Finish** Button.

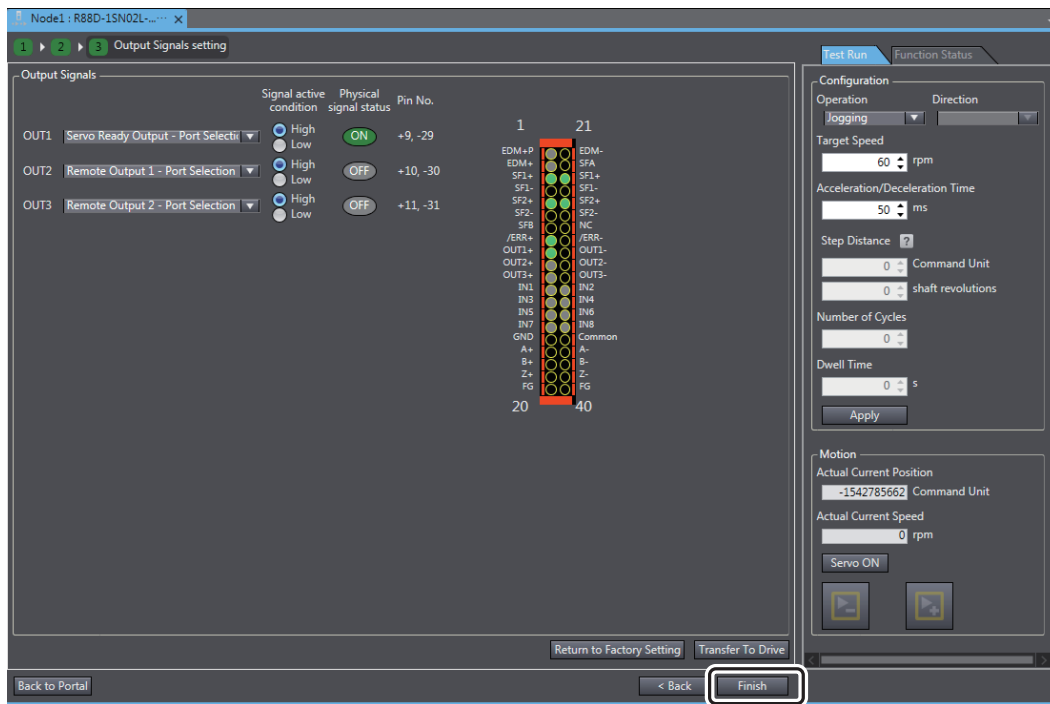

You return to Setup and Tuning Portal.

Servo parameter errors will no longer occur in the CPU Unit.
Set Node2: R88D-1SN01L-ECT(E002) in the same way as Node1.

A-2 Using the 3D Motion Trace Display Mode to Check Operation

In 4-4-3 *Using Data Tracing to Check Operation*, we checked the traced data on a timeline to confirm that the system operation was correct. In this appendix, we will explain how to use the 3D Motion Trace Display Mode to check the current operation. The 3D Motion Trace Display Mode shows a 3D model that moves according to the movements of the axes to allow you to visually confirm the executed operations. It has the following features.

- The display can be linked to a data trace time chart graph.
- You can also display the path of a marker on the 3D Equipment Model at the same time.
- You can display the 2D paths of the markers for the projections in the 3D Equipment Model Display.
- You can simultaneously display the command values to the Servo Drives and the feedback (actual) values from the Servo Drives.

Refer to the *Sysmac Studio Version 1 Operation Manual* (Cat. No. W504) for details on the 3D Motion Trace Display Mode.

- 1 Double-click **DataTrace0** under **Configurations and Setup – Data Trace Settings** in the Multi-view Explorer.

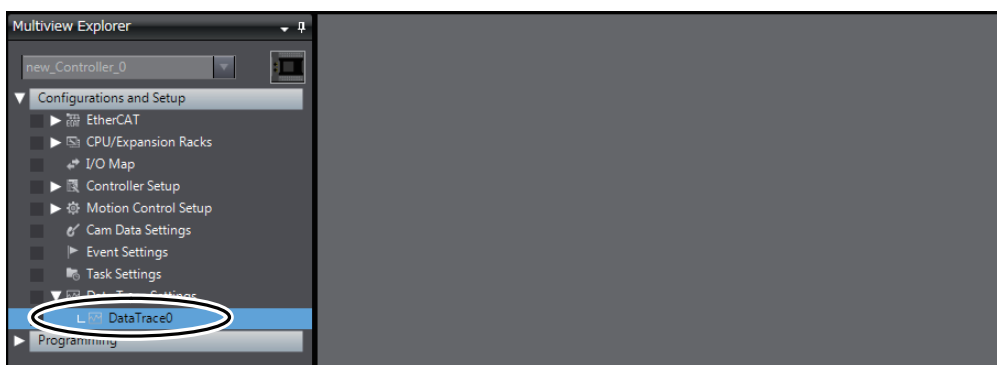

The DataTrace0 Tab Page is displayed in the Edit Pane.

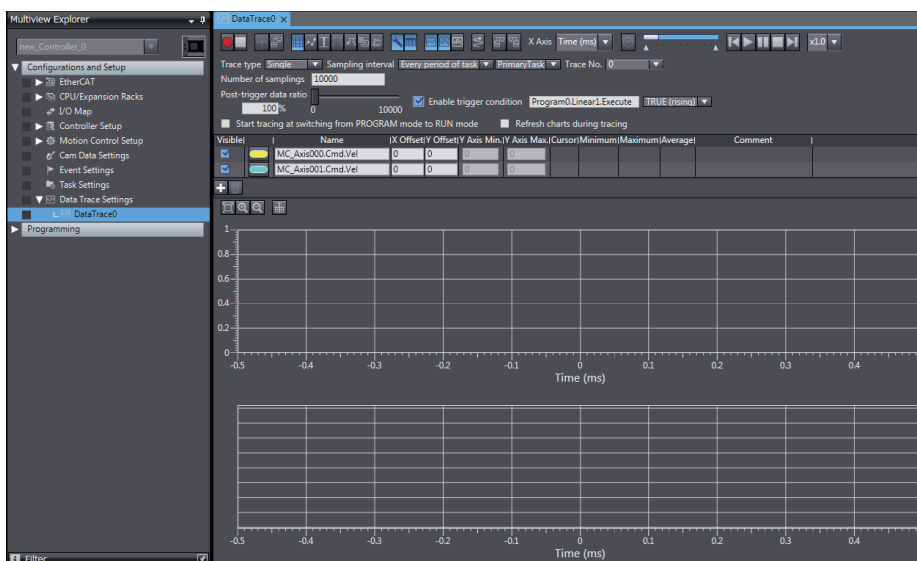

2 Click the **3D** Button in the Edit Pane.

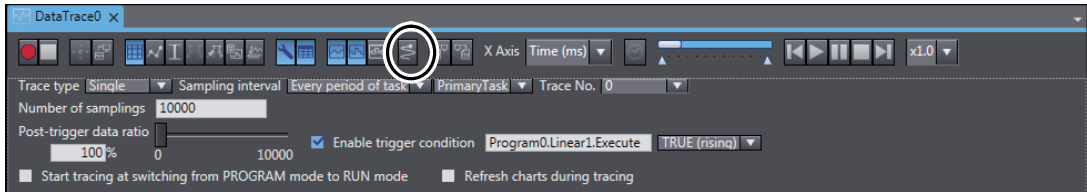

3 Click the **Settings** Button for 3D equipment model and select **Add** from the menu.

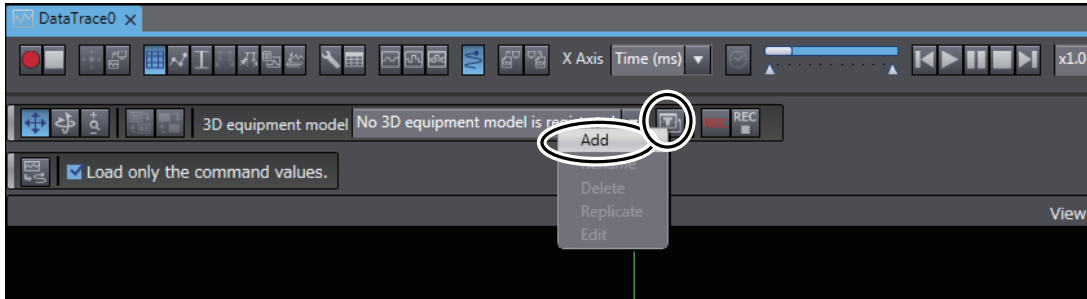

4 When the 3D Equipment Model Display appears, click the **OK** Button.

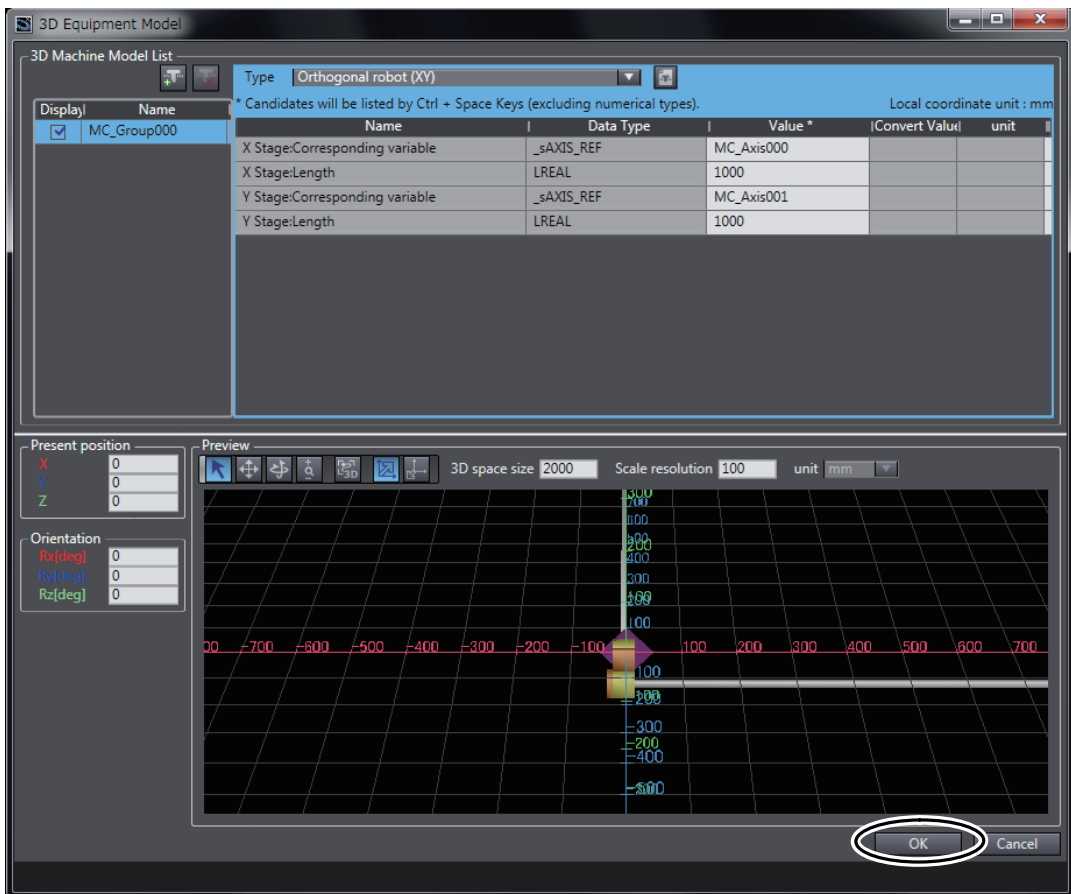

The axis variables that are required for the 3D Motion Trace Display are added to the list of variables to trace.

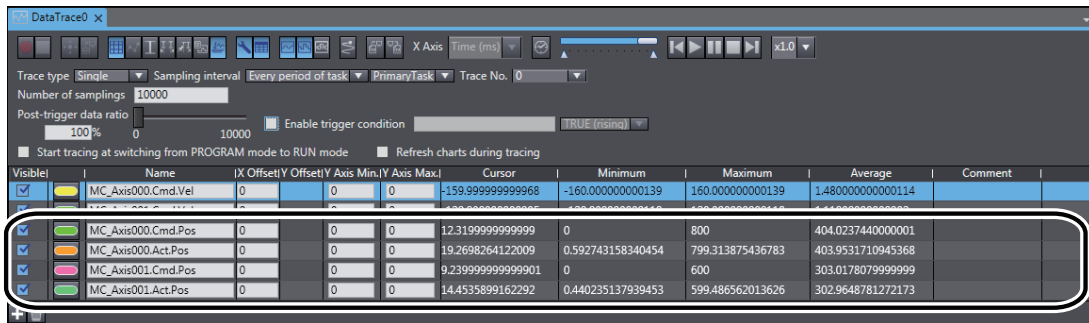

- 5 Select the *Enable trigger condition* Check Box on the DataTrace0 Tab Page and enter the *Program0.Linear1.Execute* variable to use as the trigger condition.

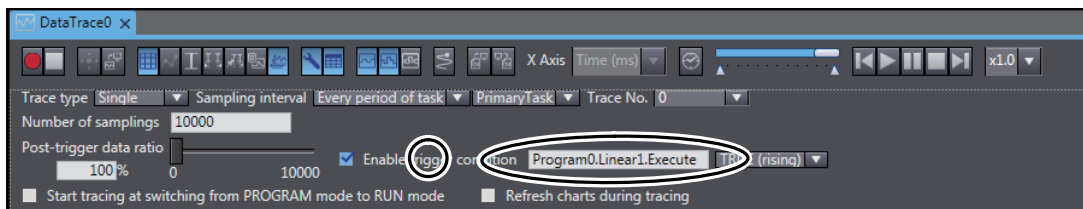

- 6 Click the **Start Trace** Button.

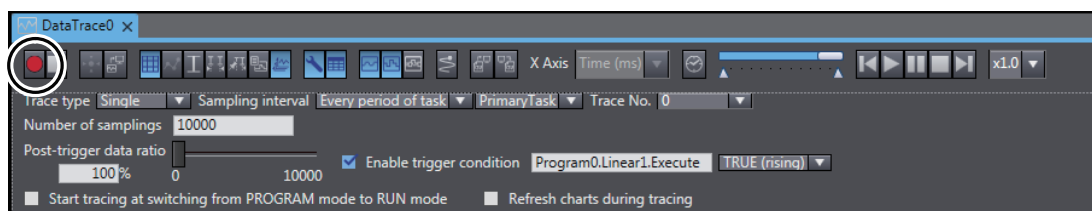

A

7 Make sure that the status bar at the lower left changes as shown in the following figure.

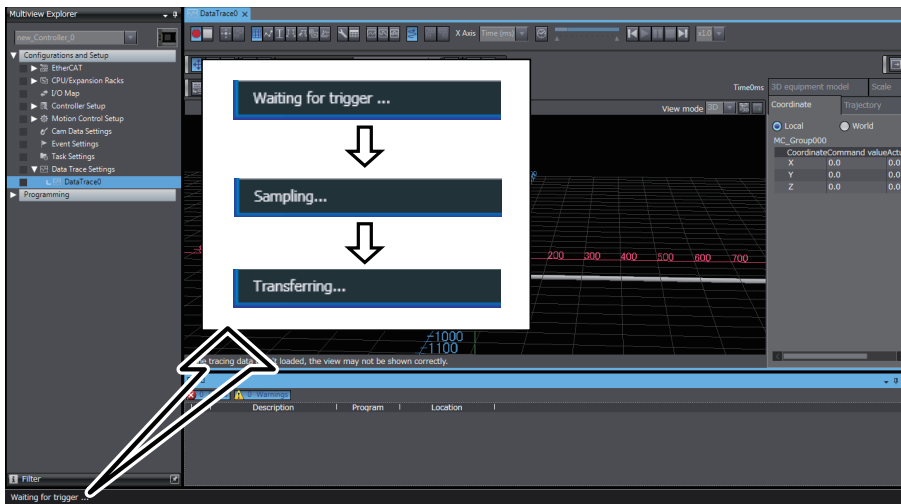

The following dialog box appears. Click the **Yes** Button.

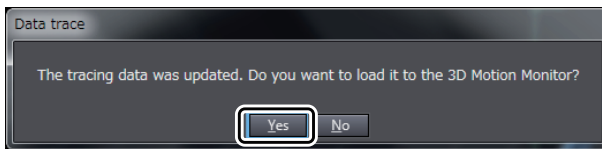

The results of the data trace are displayed on the 3D Motion Trace Display.

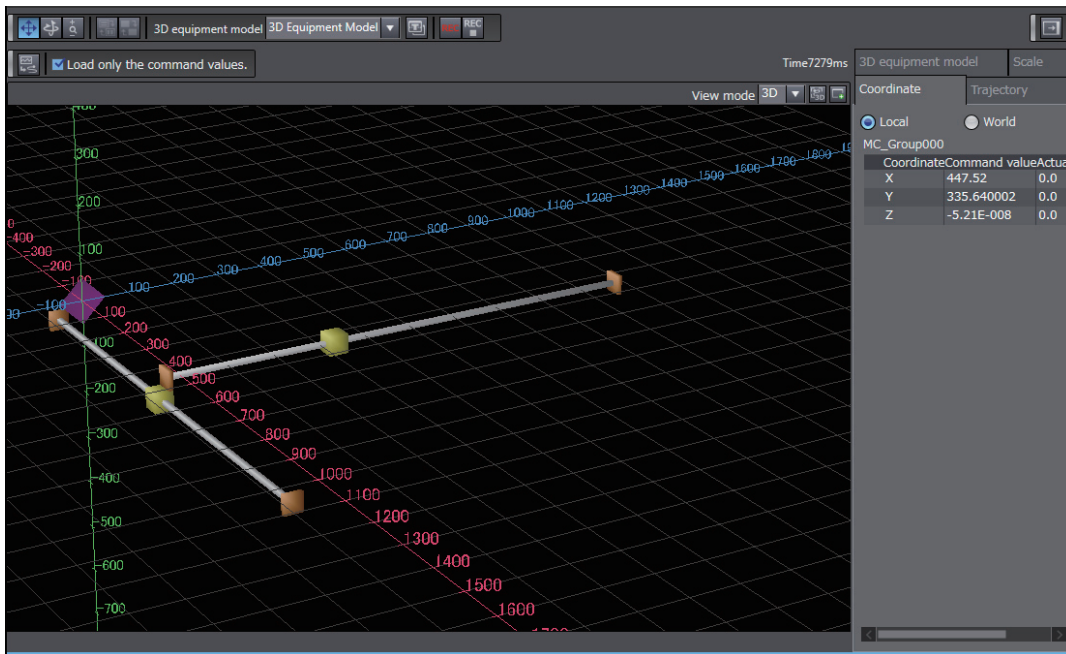

8 Click the *View Mode Box* in the 3D Motion Trace Display and select X-Y from the list.

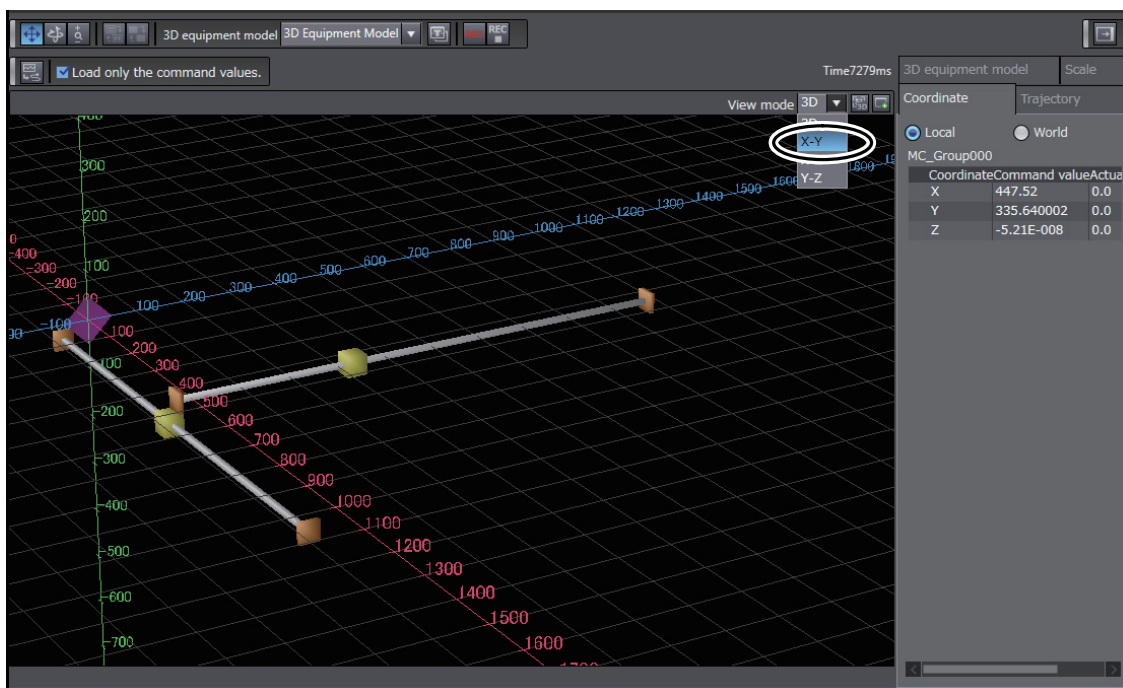

A-2 Using the 3D Motion Trace Display Mode to Check Operation

A

The results of the data trace are displayed in Cartesian coordinates with axis 0 as the X axis and axis 1 as the Y axis.

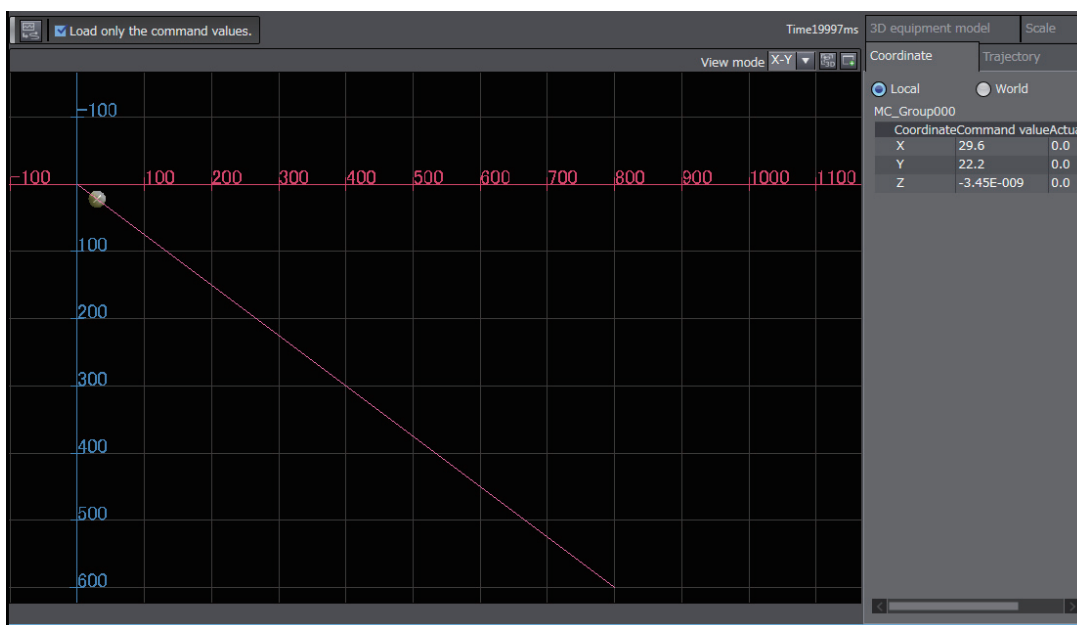

Make sure that the trace results show the same operation as shown in 4-1 *Two-axis Servo System Operation*.

OMRON AUTOMATION AMERICAS HEADQUARTERS • Chicago, IL USA • 847.843.7900 • 800.556.6766 • www.omron247.com

OMRON CANADA, INC. • HEAD OFFICE

Toronto, ON, Canada • 416.286.6465 • 866.986.6766 • www.omron247.com

OMRON ELECTRONICS DE MEXICO • HEAD OFFICE

México DF • 52.55.59.01.43.00 • 01-800-226-6766 • mela@omron.com

OMRON ELECTRONICS DE MEXICO • SALES OFFICE

Apodaca, N.L. • 52.81.11.56.99.20 • 01-800-226-6766 • mela@omron.com

OMRON ELETRÔNICA DO BRASIL LTDA • HEAD OFFICE

São Paulo, SP, Brasil • 55.11.2101.6300 • www.omron.com.br

OMRON ARGENTINA • SALES OFFICE

Cono Sur • 54.11.4783.5300

OMRON CHILE • SALES OFFICE

Santiago • 56.9.9917.3920

OTHER OMRON LATIN AMERICA SALES

54.11.4783.5300

OMRON EUROPE B.V. • Wegalaan 67-69, NL-2132 JD, Hoofddorp, The Netherlands. • +31 (0) 23 568 13 00 • www.industrial.omron.eu

Authorized Distributor:

Controllers & I/O

- Machine Automation Controllers (MAC) • Motion Controllers
- Programmable Logic Controllers (PLC) • Temperature Controllers • Remote I/O

Robotics

- Industrial Robots • Mobile Robots

Operator Interfaces

- Human Machine Interface (HMI)

Motion & Drives

- Machine Automation Controllers (MAC) • Motion Controllers • Servo Systems
- Frequency Inverters

Vision, Measurement & Identification

- Vision Sensors & Systems • Measurement Sensors • Auto Identification Systems

Sensing

- Photoelectric Sensors • Fiber-Optic Sensors • Proximity Sensors
- Rotary Encoders • Ultrasonic Sensors

Safety

- Safety Light Curtains • Safety Laser Scanners • Programmable Safety Systems
- Safety Mats and Edges • Safety Door Switches • Emergency Stop Devices
- Safety Switches & Operator Controls • Safety Monitoring/Force-guided Relays

Control Components

- Power Supplies • Timers • Counters • Programmable Relays
- Digital Panel Meters • Monitoring Products

Switches & Relays

- Limit Switches • Pushbutton Switches • Electromechanical Relays
- Solid State Relays

Software

- Programming & Configuration • Runtime