

Programmable Terminal

NA-series

Hardware

User's Manual

NA5-15□101□

NA5-12□101□

NA5-9□001□

NA5-7□001□



NOTE

All rights reserved. No part of this publication may be reproduced, stored in a retrieval system, or transmitted, in any form, or by any means, mechanical, electronic, photocopying, recording, or otherwise, without the prior written permission of OMRON.

No patent liability is assumed with respect to the use of the information contained herein. Moreover, because OMRON is constantly striving to improve its high-quality products, the information contained in this manual is subject to change without notice. Every precaution has been taken in the preparation of this manual. Nevertheless, OMRON assumes no responsibility for errors or omissions. Neither is any liability assumed for damages resulting from the use of the information contained in this publication.

Trademarks

- Sysmac and SYSMAC are trademarks or registered trademarks of OMRON Corporation in Japan and other countries for OMRON factory automation products.
- Microsoft, Windows, Windows Vista, Excel, and Visual Basic are either registered trademarks or trademarks of Microsoft Corporation in the United States and other countries.
- EtherCAT® is registered trademark and patented technology, licensed by Beckhoff Automation GmbH, Germany.
- ODVA, CIP, CompoNet, DeviceNet, and EtherNet/IP are trademarks of ODVA.
- The SD and SDHC logos are trademarks of SD-3C, LLC. 
- Portions of this software are copyright 2014 The FreeType Project (www.freetype.org). All rights reserved.

Other company names and product names in this document are the trademarks or registered trademarks of their respective companies.

Copyrights

Microsoft product screen shots reprinted with permission from Microsoft Corporation.

Introduction

Thank you for purchasing an NA-series Programmable Terminal.

This manual contains information that is necessary to use the NA-series Programmable Terminal. Please read this manual and make sure you understand the functionality and performance of the NA-series Programmable Terminal before you attempt to use it in a control system.

Keep this manual in a safe place where it will be available for reference during operation.

Intended Audience

This manual is intended for the following personnel, who must also have knowledge of electrical systems (an electrical engineer or the equivalent).

- Personnel in charge of introducing FA systems.
- Personnel in charge of designing FA systems.
- Personnel in charge of installing and maintaining FA systems.
- Personnel in charge of managing FA systems and facilities.

Applicable Products

This manual covers the following products.

- NA-series Programmable Terminals*¹

*1. Unless otherwise specified, the descriptions for the NA5-□□W□□□□ apply to the NA5-□□U□□□□ as well.

Relevant Manuals

The basic information required to use an NA-series PT is provided in the following three manuals.

- *NA-series Programmable Terminal Hardware User's Manual* (Cat. No. V117)
- *NA-series Programmable Terminal Software User's Manual* (Cat. No. V118)
- *NA-series Programmable Terminal Device Connection User's Manual* (Cat. No. V119)

Operations are performed from the Sysmac Studio Automation Software.

Refer to the *Sysmac Studio Version 1 Operation Manual* (Cat. No. W504) for information on the Sysmac Studio.

Other manuals are necessary for specific system configurations and applications.

The following manual is also available to walk you through installations and operations up to starting actual operation using simple examples.

Refer to it as required.

- *NA-series Programmable Terminal Startup Guide Manual* (Cat. No. V120)

Manual Structure

Page Structure and Markings

The following page structure is used in this manual.

The diagram illustrates the structure of a manual page with the following components and annotations:

- Level 1 heading:** 3 Installation and Wiring
- Level 2 heading:** 3-3 Installing NA-series PTs
- Level 3 heading:** 3-3-1 Installation in a Control Panel
- Page tab:** 3
- A step in a procedure:** 1 Open a hole in which to embed the NA-series PT with the following dimensions and insert the NA-series PT from the front side of the panel.
- Special information:** Additional Information. You can use an NS-USBEXT-1M USB Relay Cable to extend the USB slave connector on the back panel of the NA-series PT to the front surface of a control panel. If you use the USB Relay Cable, open a hole with the following dimensions and install the Cable.
- Manual name:** NA Series Programmable Terminal Hardware User's Manual (V117)

Additional annotations include: "Give the current headings." pointing to the Level 2 and 3 headings, and "Indicates a procedure." pointing to the step number '1'.

Note This illustration is provided only as a sample. It may not literally appear in this manual.

Special Information

Special information in this manual is classified as follows:



Precautions for Safe Use

Precautions on what to do and what not to do to ensure safe usage of the product.



Precautions for Correct Use

Indicates precautions on what to do and what not to do to ensure proper operation and performance.



Additional Information

Additional information to read as required.

This information is provided to increase understanding or make operation easier.



Version Information

Information on differences in specifications and functionality with different versions is given.

Sections in this Manual

1	Introduction to the NA-series Programmable Terminals	1
2	Configuration Units	2
3	Installation and Wiring	3
4	System Program	4
5	Troubleshooting	5
6	Maintenance	6
A	Appendices	A
I	Index	I

CONTENTS

Introduction.....	1
Relevant Manuals.....	2
Manual Structure.....	3
Sections in this Manual.....	5
Terms and Conditions Agreement	11
Safety Precautions.....	13
Precautions for Safe Use	15
Precautions for Correct Use	18
Regulations and Standards	19
Conformance to Shipbuilding Standards	21
Related Manuals.....	23
Terminology.....	27
Revision History.....	28

Section 1 Introduction to the NA-series Programmable Terminals

1-1 NA-series Programmable Terminals.....	1-2
1-1-1 Features.....	1-2
1-2 System Configurations	1-4
1-2-1 Connecting to the Support Software.....	1-4
1-2-2 Network Configuration with Other Devices	1-4
1-3 Available Products	1-5
1-3-1 NA Units.....	1-5
1-3-2 Support Software	1-5
1-3-3 Other Optional Products	1-6
1-4 Specifications	1-7
1-4-1 General Specifications	1-7
1-4-2 Performance Specifications	1-10

Section 2 Configuration Units

2-1 NA Units	2-2
2-1-1 Components and Functions.....	2-2
2-2 SD Memory Cards.....	2-9
2-2-1 Models and Specifications	2-9
2-2-2 Applications	2-9
2-2-3 Installing and Removing	2-9

2-3	USB Memory Devices	2-11
2-3-1	Models and Specifications	2-11
2-3-2	Applications.....	2-11
2-3-3	Installing and Removing.....	2-11
2-4	Support Software	2-13
2-4-1	Connection Methods	2-13

Section 3 Installation and Wiring

3-1	Processing at Power ON and Power OFF	3-2
3-1-1	Power ON Operation.....	3-2
3-1-2	Power OFF Operation.....	3-2
3-2	Fail-safe Measures	3-3
3-2-1	Power ON Sequence	3-3
3-3	Installing NA Units	3-4
3-3-1	Installation in a Control Panel	3-4
3-4	Wiring Methods	3-9
3-4-1	Power Supply Wiring.....	3-9
3-4-2	Wiring the Ethernet Port.....	3-13
3-4-3	Wiring the Serial Port.....	3-13
3-5	Control Panel Installation	3-14
3-5-1	Temperature.....	3-14
3-5-2	Humidity	3-15
3-5-3	Vibration and Shock.....	3-16
3-5-4	Atmosphere.....	3-16
3-5-5	Electrical Environment	3-17
3-5-6	Grounding	3-19

Section 4 System Program

4-1	System Program and NA Unit Startup Status	4-2
4-2	System Recovery	4-3
4-3	System Menu Overview	4-6
4-3-1	System Menu Configuration.....	4-6
4-3-2	Using the System Menu	4-9
4-4	System Menu Details	4-11
4-4-1	Display Settings (Project System Menu).....	4-11
4-4-2	Language Settings (Project System Menu).....	4-12
4-4-3	Communications Settings (Project System Menu).....	4-12
4-4-4	User Accounts (Project System Menu)	4-13
4-4-5	NJ/NX Troubleshooter (Project System Menu).....	4-14
4-4-6	Alarm Viewer (Project System Menu)	4-25
4-4-7	Project System Menu Settings (Project System Menu)	4-27
4-4-8	Print Settings (Project System Menu)	4-27
4-4-9	Buzzer Settings (Project System Menu)	4-28
4-4-10	Date & Time Settings (Device System Menu).....	4-29
4-4-11	Language Settings (Device System Menu).....	4-29
4-4-12	Interface Settings (Device System Menu).....	4-30
4-4-13	Brightness Settings (Device System Menu).....	4-35
4-4-14	Transfer Operations (Device System Menu).....	4-36
4-4-15	Hardware Diagnostics (Device System Menu).....	4-41
4-4-16	Production Information (Device System Menu).....	4-44

Section 5 Troubleshooting

5-1	Operation after an Error	5-2
5-1-1	Checking NA Unit Status	5-2
5-1-2	Fatal Errors in the NA Unit	5-2
5-1-3	Nonfatal Errors in the NA Unit	5-3
5-2	Troubleshooting	5-4
5-2-1	Confirming NA Unit Operation	5-4
5-2-2	Correcting Fatal Errors in the NA Unit	5-4
5-2-3	Troubleshooting Non-fatal Errors	5-5
5-2-4	Causes and Correction When You Cannot Go Online from the Sysmac Studio	5-5
5-2-5	Troubleshooting NA Unit Errors	5-9

Section 6 Maintenance

6-1	Periodic Maintenance and Inspection	6-2
6-1-1	Preparations for Problems	6-2
6-1-2	Periodic Inspection	6-2
6-1-3	Precautions When Replacing the NA Unit	6-4
6-1-4	Cleaning	6-4
6-2	Replacing the Battery	6-5
6-2-1	Battery Replacement	6-5
6-2-2	Operation without a Battery	6-6

Appendices

A-1	Dimensions	A-2
A-1-1	NA Units	A-2
A-2	Available Products	A-6
A-2-1	Optional Products	A-6

Index

Terms and Conditions Agreement

Warranty, Limitations of Liability

Warranties

- **Exclusive Warranty**

Omron's exclusive warranty is that the Products will be free from defects in materials and workmanship for a period of twelve months from the date of sale by Omron (or such other period expressed in writing by Omron). Omron disclaims all other warranties, express or implied.

- **Limitations**

OMRON MAKES NO WARRANTY OR REPRESENTATION, EXPRESS OR IMPLIED, ABOUT NON-INFRINGEMENT, MERCHANTABILITY OR FITNESS FOR A PARTICULAR PURPOSE OF THE PRODUCTS. BUYER ACKNOWLEDGES THAT IT ALONE HAS DETERMINED THAT THE PRODUCTS WILL SUITABLY MEET THE REQUIREMENTS OF THEIR INTENDED USE.

Omron further disclaims all warranties and responsibility of any type for claims or expenses based on infringement by the Products or otherwise of any intellectual property right.

- **Buyer Remedy**

Omron's sole obligation hereunder shall be, at Omron's election, to (i) replace (in the form originally shipped with Buyer responsible for labor charges for removal or replacement thereof) the non-complying Product, (ii) repair the non-complying Product, or (iii) repay or credit Buyer an amount equal to the purchase price of the non-complying Product; provided that in no event shall Omron be responsible for warranty, repair, indemnity or any other claims or expenses regarding the Products unless Omron's analysis confirms that the Products were properly handled, stored, installed and maintained and not subject to contamination, abuse, misuse or inappropriate modification. Return of any Products by Buyer must be approved in writing by Omron before shipment. Omron Companies shall not be liable for the suitability or unsuitability or the results from the use of Products in combination with any electrical or electronic components, circuits, system assemblies or any other materials or substances or environments. Any advice, recommendations or information given orally or in writing, are not to be construed as an amendment or addition to the above warranty.

See <http://www.omron.com/global/> or contact your Omron representative for published information.

Limitation on Liability; Etc

OMRON COMPANIES SHALL NOT BE LIABLE FOR SPECIAL, INDIRECT, INCIDENTAL, OR CONSEQUENTIAL DAMAGES, LOSS OF PROFITS OR PRODUCTION OR COMMERCIAL LOSS IN ANY WAY CONNECTED WITH THE PRODUCTS, WHETHER SUCH CLAIM IS BASED IN CONTRACT, WARRANTY, NEGLIGENCE OR STRICT LIABILITY.

Further, in no event shall liability of Omron Companies exceed the individual price of the Product on which liability is asserted.

Application Considerations

Suitability of Use

Omron Companies shall not be responsible for conformity with any standards, codes or regulations which apply to the combination of the Product in the Buyer's application or use of the Product. At Buyer's request, Omron will provide applicable third party certification documents identifying ratings and limitations of use which apply to the Product. This information by itself is not sufficient for a complete determination of the suitability of the Product in combination with the end product, machine, system, or other application or use. Buyer shall be solely responsible for determining appropriateness of the particular Product with respect to Buyer's application, product or system. Buyer shall take application responsibility in all cases.

NEVER USE THE PRODUCT FOR AN APPLICATION INVOLVING SERIOUS RISK TO LIFE OR PROPERTY WITHOUT ENSURING THAT THE SYSTEM AS A WHOLE HAS BEEN DESIGNED TO ADDRESS THE RISKS, AND THAT THE OMRON PRODUCT(S) IS PROPERLY RATED AND INSTALLED FOR THE INTENDED USE WITHIN THE OVERALL EQUIPMENT OR SYSTEM.

Programmable Products

Omron Companies shall not be responsible for the user's programming of a programmable Product, or any consequence thereof.

Disclaimers

Performance Data

Data presented in Omron Company websites, catalogs and other materials is provided as a guide for the user in determining suitability and does not constitute a warranty. It may represent the result of Omron's test conditions, and the user must correlate it to actual application requirements. Actual performance is subject to the Omron's Warranty and Limitations of Liability.

Change in Specifications

Product specifications and accessories may be changed at any time based on improvements and other reasons. It is our practice to change part numbers when published ratings or features are changed, or when significant construction changes are made. However, some specifications of the Product may be changed without any notice. When in doubt, special part numbers may be assigned to fix or establish key specifications for your application. Please consult with your Omron's representative at any time to confirm actual specifications of purchased Product.

Errors and Omissions

Information presented by Omron Companies has been checked and is believed to be accurate; however, no responsibility is assumed for clerical, typographical or proofreading errors or omissions.

Safety Precautions

Definition of Precautionary Information

The following notation is used in this manual to provide precautions required to ensure safe usage of the NA-series Programmable Terminal. The safety precautions that are provided are extremely important to safety. Always read and heed the information provided in all safety precautions.

The following notation is used.



WARNING

Indicates a potentially hazardous situation which, if not avoided, could result in mild or moderate injury or at the worst, serious injury or death. Additionally, there may be severe property damage.



Caution

Indicates a potentially hazardous situation which, if not avoided, may result in minor or moderate injury, or property damage.



Precautions for Safe Use

Indicates precautions on what to do and what not to do to ensure safe usage of the product.



Precautions for Correct Use

Indicates precautions on what to do and what not to do to ensure proper operation and performance.

Symbols











The circle and slash symbol indicates operations that you must not do.
The specific operation is shown in the circle and explained in text.
This example indicates prohibiting disassembly.



The triangle symbol indicates precautions (including warnings).
The specific operation is shown in the triangle and explained in text.
This example indicates a general precaution.

Warnings

 WARNING	
Do not attempt to take the NA Unit apart and do not touch the product inside while the power is being supplied. Otherwise it may result in electric shock.	
Always ensure that the personnel in charge confirm that installation, inspection, and maintenance were properly performed for the NA Unit. "Personnel in charge" refers to individuals qualified and responsible for ensuring safety during machine design, installation, operation, maintenance, and disposal.	
Ensure that installation and post-installation checks are performed by personnel in charge who possess a thorough understanding of the machinery to be installed.	
Do not use the input functions such as the touch panel or function keys of the NA Unit, in applications that involve human life, in applications that may result in serious injury, or for emergency stop switches.	
Do not attempt to disassemble, repair, or modify the NA Unit. It may cause NA Unit to lose its safety function.	
Never press two points or more on the touch panel of the NA Unit at a time. Touching two points or more interrupts normal touch panel operations.	
To conform to UL Type 4X standards, always use the NA5-□□W□□□□ with a High-pressure Waterproof Attachment (PWA). If you do not use a PWA, there is a risk of water entry, which may cause severe equipment damage.	
Always pay attention to the inside dimensions when you mount a PWA on the NA5-□□W□□□□. If you do not mount the PWA correctly, there is a risk of water entry, which may cause severe equipment damage.	

Precautions for Safe Use

- When unpacking the NA Unit, check carefully for any external scratches or other damages. Also, shake the NA Unit gently and check for any abnormal sound.
- The NA Unit must be installed in a control panel.
- To conform to UL Type 1 standards, the mounting panel thickness must be 1.6 to 6.0 mm. To conform to UL Type 4X standards, the thickness must be 1.6 to 4.5 mm. To conform to UL Type 4X standards, always use the NA5-□□W□□□□ with a High-pressure Waterproof Attachment (PWA). If you do not use a PWA, there is a risk of water entry, which may cause severe equipment damage. Do not use the NA Unit outdoors. Tighten the Mounting Brackets evenly to a torque of between 0.5 and 0.6 N·m to maintain water and dust resistance. If the tightening torque exceeds the specified value, or the tightening is not even, deformation of the front panel may occur. What is more, make sure the panel is not dirty or warped, that the front surface is smooth, and that the panel is strong enough to hold the NA Unit.
- Do not let metal particles enter the NA Unit when preparing the panel.
- Turn OFF the power supply before connecting or disconnecting cables.
- Periodically check the installation conditions in applications where the NA Unit is subject to contact with oil or water.
- Be certain to use the cables with lock mechanism such as serial cable or the Ethernet cable after confirming if it is securely locked.
- Do not touch the packaging part of the circuit board with your bare hands. Discharge any static electricity from your body before handling the board.
- Do not use volatile solvents such as benzene and thinners or chemical cloths.
- Water and oil resistance will be lost if the front sheet is torn or is peeling off. Do not use the NA Unit, if the front sheet is torn or is peeling off.
- As the rubber packing will deteriorate, shrink, or harden depending on the operating environment, periodical inspection is necessary.
- Confirm the safety of the system before turning ON or OFF the power supply, or pressing the reset switch.
- The whole system may stop depending on how the power supply is turned ON or OFF. Turn ON/OFF the power supply according to the specified procedure.
- Operate DIP switch according to the following way.

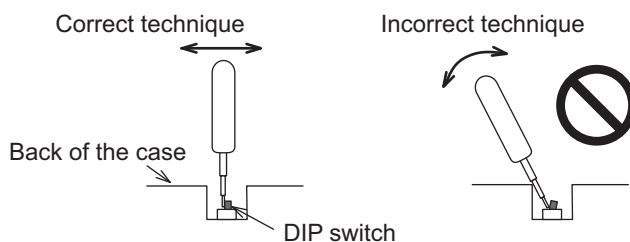

The DIP switch may break if it is levered with a tool against the case as shown in the figure.

- Once the DIP switch settings are changed, reset by pressing the reset switch, or restart the power supply.
- Initialize the project, after confirming that existing project is backed up at the Sysmac Studio.
- When changing the password, do not reset or turn OFF the power supply until the writing is completed. A failure to store the password may cause the project to fail to function.
- While uploading or downloading a project or a system program, do not perform the operations as follows. Such operations may corrupt the project or the system program:
 - Turning OFF the power supply of the NA Unit.
 - Resetting the NA Unit.
 - Removing the USB devices or SD card.

- Disconnecting the cable between a support tool and the NA Unit.
- Do not connect an AC power supply to the DC power terminals.
- Do not perform a dielectric strength test.
- Use a DC power with a slight voltage fluctuation and that will provide a stable output even if the input is momentarily interrupted for 10 ms. Also use the one with reinforced insulation or double insulation.
Rated Power Supply Voltage: 24VDC (Allowable range 19.2 to 28.8VDC)
- Use a power cable with AWG#12 to #22 thick (0.35mm² to 3.31mm²). Peel the coating 7mm length and tighten the terminal screw with the torque in the range of 0.5 to 0.6 N·m. Also confirm if the terminal screw is tighten appropriately.
- To prevent malfunctions caused by noise, ground the NA Unit correctly.
- Do not use any battery if strong impact is applied to it (e.g. by dropping on the floor) because such a battery may cause a leakage.
- Confirm the type of the battery to install the battery properly.
- Apply power for at least five minutes before changing the battery. Mount a new battery within five minutes after turning OFF the power supply. If power is not supplied for at least five minutes, the clock data may be lost. Check the clock data after changing the battery.
- Do not dismantle a battery nor let it short-circuit.
- Do not apply an impact with the lithium battery, charge it, dispose it into a fire, or heat it. Doing either of them may cause an ignition or a bursting.
- Dispose of the NA Units and batteries according to local ordinances as they apply.



廢電池請回收

- The following precaution must be displayed on all products containing lithium primary batteries with a perchlorate content of 6ppb or higher when exporting them to or shipping them through California, USA.

Perchlorate Material - special handling may apply.

See www.dtsc.ca.gov/hazardouswaste/perchlorate

The NA-Series contains a lithium primary battery with a perchlorate content of 6ppb or higher. When exporting a product containing the NA-Series to or shipping such a product through California, USA, label all packing and shipping containers appropriately.

- Do not connect the USB devices in the environment subject to the strong vibration.
- Do not connect USB devices which are not allowed to connect to NA Unit.
- Start actual system application only after checking normal operation of the system including storage devices such as USB memory and SD card.
- When connecting peripheral devices which do not meet the performance level of the NA Unit for noise and static electricity, ensure sufficient countermeasures against noise and static electricity during installation of the peripheral devices to the NA Unit.
- Do not carry out the following operations when accessing USB devices or SD card:
 - Turning OFF the power supply of the NA Unit
 - Press the Reset switch of the NA Unit
 - Pull out the USB devices or SD card
- When using the No. 6 pin of the serial port connector for a voltage of DC+5V, make sure the supply equipment's current capacity is below 250mA before using it. The DC+5V voltage output of the NA Unit is +5V±5%, and the maximum current is 250mA.
- To ensure the system's safety, make sure to incorporate a program that call periodically signals during the operation at connected device side and can confirm the normal functionality of the NA Unit before running the system.
- Start actual system application only after sufficiently checking project, subroutine and the operation of the program at the connected device side.
- To execute a subroutine with multiple threads, fully check the operation of the program that takes multithreads into consideration, before starting actual system application.

- To use numeric input functions safely, always make maximum and minimum limit settings.
- Do not press the touch panel with a force greater than 30 N.
- Do not use hard or pointed objects to operate or scrub the screen, otherwise the surface of the screen may be damaged.
- The deterioration over time may cause the touch points to move on the touch panel. Calibrate the touch panel periodically.
- A touch position detection error of approximately 20 pixels may occur due to the precision of the touch panel. Always take this into account when positioning objects on the panel so adjoining objects will not be activated by mistake.
- Confirm the safety of the system before pressing the touch panel.
- Do not accidentally press the touch panel when the backlight is not lit or when the display does not appear or is too dark to identify visually.
- You can change the brightness by changing the setting such as in the system menu or by downloading project.
If the brightness is set to very dark, it causes flickering or unreadable screen. Additionally, the brightness can be restored by transferring the project again after setting the property of the brightness appropriately.
In a case of the applications where end users can control the brightness, create the applications so as keeping on operations by such as assigning the function which restores the brightness to one of function keys, if necessary.
- Signals from the touch panel may not be entered if the touch panel is pressed consecutively at high speed. Make sure to go on the next operation after confirming that the NA Unit has detected the input of the touch panel.
- The function keys have the restrictions as follows:
 - When you use gloves or others, the function keys may not work correctly depending on the material and thickness of the gloves. Take actual conditions of the gloves usage into considerations prior to the system startup to perform the confirmation.
 - The function keys do not work when covered with water. Remove the water completely before use.

Precautions for Correct Use

- **Do not install or store the NA Unit in any of the following locations:**
 - Locations subject to severe changes in temperature
 - Locations subject to temperatures or humidity outside the range specified in the specifications
 - Locations subject to condensation as the result of high humidity
 - Locations subject to corrosive or flammable gases
 - Locations subject to strong shock or vibration
 - Locations outdoors subject to direct wind and rain
 - Locations subject to strong ultraviolet light
 - Locations subject to dust
 - Locations subject to direct sunlight
 - Locations subject to splashing oil or chemicals

- **Take appropriate and sufficient countermeasures when installing systems in the following locations:**
 - Locations subject to static electricity or other forms of noise
 - Locations subject to strong electric field or magnetic field
 - Locations close to power supply lines
 - Locations subject to possible exposure to radioactivity

- **Mounting Panel**
 - To conform to UL Type 1 standards, the mounting panel thickness must be 1.6 to 6.0 mm.
 - To conform to UL Type 4X standards, the thickness must be 1.6 to 4.5 mm.
To conform to UL Type 4X standards, always use the NA5-□□W□□□□ with a High-pressure Waterproof Attachment (PWA). If you do not use a PWA, there is a risk of water entry, which may cause severe equipment damage.
 - Tighten the Mounting Brackets evenly to a torque of between 0.5 and 0.6 N·m to maintain water and dust resistance. If the tightening torque exceeds the specified range or the tightening is not even, deformation of the front panel may occur. Make sure the panel is not dirty or warped, that the front surface is smooth, and that the panel is strong enough to hold the NA Unit.

Regulations and Standards

Conformance to EC Directives

Applicable Directives

- EMC Directive

Concepts

● EMC Directive

OMRON devices that comply with EC Directives also conform to the related EMC standards so that they can be more easily built into other devices or the overall machine. The actual products have been checked for conformity to EMC standards.*

Whether the products conform to the standards in the system used by the customer, however, must be checked by the customer. EMC-related performance of the OMRON devices that comply with EC Directives will vary depending on the configuration, wiring, and other conditions of the equipment or control panel on which the OMRON devices are installed. The customer must, therefore, perform the final check to confirm that devices and the overall machine conform to EMC standards.

- * Applicable EMC (Electromagnetic Compatibility) standards are as follows:
EMS (Electromagnetic Susceptibility): EN 61131-2:2007
EMI (Electromagnetic Interference): EN 61131-2:2007

● Conformance to EC Directives

The NA-series PTs comply with EC Directives. To ensure that the machine or device in which the NA-series PT is used complies with EC Directives, the NA-series PT must be installed as follows:

- The NA Unit must be installed in a control panel.
- You must use reinforced insulation or double insulation for the DC power supplies connected to the NA Unit.
- NA-series PTs that comply with EC Directives also conform to the Common Emission Standard (EN 61000-6-4). Radiated emission characteristics (10-m regulations) may vary depending on the configuration of the control panel used, other devices connected to the control panel, wiring, and other conditions.
You must therefore confirm that the overall machine or equipment complies with EC Directives.
- This is a Class A product (for industrial environments). In a residential environment, it may cause radio interference, in which case the user may be required to take appropriate measures.

Conformance to KC Standards

Observe the following precaution if you use NA-series PTs in Korea.

A 급 기기 (업무용 방송통신기자재)

이 기기는 업무용(A 급) 전자파적합기기로서 판매자 또는 사용자는 이 점을 주의하시기 바라며, 가정외의 지역에서 사용하는 것을 목적으로 합니다.

Class A Device (Broadcasting Communications Device for Business Use)

This device obtained EMC registration for office use (Class A), and it is intended to be used in places other than homes. Sellers and/or users need to take note of this.

Conformance to Shipbuilding Standards

The NA-series Programmable Terminals comply with shipping standards. Application conditions are set for compliance for individual shipping standards, and it may not be possible to use the product in some installation locations. Contact an OMRON sales representative before using the product.

● International Shipping Standards

Shipping Standards of Various Countries

Abbreviation	Country	Name
NK	Japan	Nippon Kaiji Kyokai
LR	Great Britain	Lloyd's Register of Shipping
DNV	Norway	Det Norske Veritas
RINA	Italy	Registro Italiano Navale
BV	France	Bureau Veritas
GL	Germany	Germanischer Lloyd
ABS	USA	American Bureau of Shipping
KR	South Korea	Korean Register of Shipping
CR	Taiwan	China Corporation Register of Shipping

● Certification Status for NA Units

The following table shows the certification status with shipping standards for NA Units as of October 2015.

Abbreviation	NA5W-15□□□□	NA5W-12□□□□	NA5W-9□□□□	NA5W-7□□□□
NK	Certified	Certified	Certified	Certified
LR	Certified	Certified	Certified	Certified
DNV	Certified	Certified	Certified	Certified
RINA	Uncertified	Uncertified	Uncertified	Uncertified
BV	Uncertified	Uncertified	Uncertified	Uncertified
GL	Uncertified	Uncertified	Uncertified	Uncertified
ABS	Uncertified	Uncertified	Uncertified	Uncertified
KR	Uncertified	Uncertified	Uncertified	Uncertified
CR	Uncertified	Uncertified	Uncertified	Uncertified

Abbreviation	NA5-15U□□□□	NA5-12U□□□□	NA5-9U□□□□	NA5-7U□□□□
NK	Uncertified ^{*1}	Uncertified ^{*1}	Uncertified ^{*1}	Uncertified ^{*1}
LR	Certified	Certified	Certified	Certified
DNV	Uncertified ^{*1}	Uncertified ^{*1}	Uncertified ^{*1}	Uncertified ^{*1}
RINA	Uncertified	Uncertified	Uncertified	Uncertified
BV	Uncertified	Uncertified	Uncertified	Uncertified
GL	Uncertified	Uncertified	Uncertified	Uncertified
ABS	Uncertified	Uncertified	Uncertified	Uncertified
KR	Uncertified	Uncertified	Uncertified	Uncertified
CR	Uncertified	Uncertified	Uncertified	Uncertified

*1. The criteria in the relevant standards have been met but certification is pending.

● **Certification Zones for Shipping Standards**

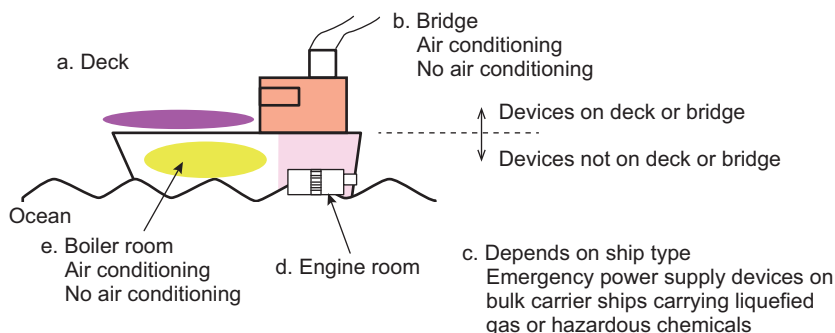

- a. Deck zone
- b. Zones with and without air conditioning on the bridge (e.g., helm room)
- c. Depends on the ship type. Emergency power supply devices on bulk carrier ships carrying liquefied gas or hazardous chemicals.
- d. Engine room zone (devices mounted on machinery that has strict vibration conditions, such as diesel engines or air compressors)
- e. Zones with and without air conditioning not on the bridge or deck (e.g., boiler room)

● **NA Unit Certification Zones for Shipping Standards**

Standards	a. Deck	b. Bridge		c. Ship type (e.g., bulk ship with liquefied gas)	d. Engine (e.g.)	e. Not on deck or bridge	
		No air conditioning	With air conditioning			No air conditioning	With air conditioning
NK	Uncertified	Certified	Certified	Uncertified	Uncertified	Certified	Certified
LR	Uncertified	Certified	Certified	Uncertified	Uncertified	Certified	Certified
DNV	Uncertified	Certified	Certified	Uncertified	Uncertified	Certified	Certified
RINA	Uncertified	Uncertified	Uncertified	Uncertified	Uncertified	Uncertified	Uncertified
BV	Uncertified	Uncertified	Uncertified	Uncertified	Uncertified	Uncertified	Uncertified
GL	Uncertified	Uncertified	Uncertified	Uncertified	Uncertified	Uncertified	Uncertified
ABS	Uncertified	Uncertified	Uncertified	Uncertified	Uncertified	Uncertified	Uncertified
KR	Uncertified	Uncertified	Uncertified	Uncertified	Uncertified	Uncertified	Uncertified
CR	Uncertified	Uncertified	Uncertified	Uncertified	Uncertified	Uncertified	Uncertified

● **Precautions for Compliance with Shipping Standards**

1. Always install the NA Unit in a control panel.
2. Install the NA Unit in a control panel that has air conditioning.
3. Completely shield the gap at openings in the control panel or operation panel with a gasket.
4. The following noise filter must be connected to the 0-VDC to 24-VDC power supply line.

Manufacturer	Schaffner
Model	FN-2080-XX

Related Manuals

The following manuals are related to the NA-series PTs. Use these manuals for reference.

Manual name	Cat. No.	Models	Applications	Description
NA-series Programmable Terminal Hardware User's Manual	V117	NA5-□W□□□□	Learning the specifications and settings required to install an NA-series PT and connect peripheral devices.	Information is provided on NA-series PT specifications, part names, installation procedures, and procedures to connect an NA Unit to peripheral devices. Information is also provided on maintenance after operation and troubleshooting.
NA-series Programmable Terminal Software User's Manual	V118	NA5-□W□□□□	Learning about NA-series PT pages and object functions.	NA-series PT pages and object functions are described.
NA-series Programmable Terminal Device Connection User's Manual	V119	NA5-□W□□□□	Learning the specifications required to connect devices to an NA-series PT.	Information is provided on connection procedures and setting procedures to connect an NA-series PT to a Controller or other device.
NA-series Programmable Terminal Startup Guide	V120	NA5-□W□□□□	Learning in concrete terms information required to install and start the operation of an NA-series PT.	The part names and installation procedures are described followed by page creation and transfer procedures with the Sysmac Studio. Also operation, maintenance, and inspection procedures after the project is transferred are described. Sample screen captures are provided as examples.
NX-series CPU Unit Hardware User's Manual	W535	NX701-□□□□	Learning the basic specifications of the NX-series CPU Units, including introductory information, designing, installation, and maintenance. Mainly hardware information is provided.	An introduction to the entire NX-series system is provided along with the following information on the CPU Unit. <ul style="list-style-type: none"> • Features and system configuration • Introduction • Part names and functions • General specifications • Installation and wiring • Maintenance and inspection Use this manual together with the <i>NJ/NX-series CPU Unit Software User's Manual</i> (Cat. No.W501).

Manual name	Cat. No.	Models	Applications	Description
NJ-series CPU Unit Hardware User's Manual	W500	NJ501-□□□□ NJ301-□□□□ NJ101-□□□□	Learning the basic specifications of the NJ-series CPU Units, including introductory information, designing, installation, and maintenance. Mainly hardware information is provided.	An introduction to the entire NJ-series system is provided along with the following information on a Controller built with a CPU Unit. <ul style="list-style-type: none"> • Features and system configuration • Introduction • Part names and functions • General specifications • Installation and wiring • Inspection and maintenance Use this manual together with the <i>NJ-series CPU Unit Software User's Manual</i> (Cat. No. W501).
NJ/NX-series CPU Unit Software User's Manual	W501	NX701-□□□□ NJ501-□□□□ NJ301-□□□□ NJ101-□□□□	Learning how to program and set up an NJ/NX-series CPU Unit. Mainly software information is provided.	Provides the following information on a Controller built with an NJ/NX-series CPU Unit. <ul style="list-style-type: none"> • CPU Unit operation • CPU Unit features • Initial settings • Programming based on IEC 61131-3 language specifications Use this manual together with the <i>NJ/NX-series CPU Unit Hardware User's Manual</i> (NJ Series: W500, NX Series: W535).
CJ Series Programmable Controllers Operation Manual	W393	CJ1H-CPU□□H-R CJ1G/H-CPU□□H CJ1G-CPU□□P CJ1M-CPU□□ CJ1G-CPU□□	Learning the basic specifications of the CJ-series PLCs, including introductory information, designing, installation, and maintenance.	The following information is provided on a CJ-series PLC. <ul style="list-style-type: none"> • Introduction and features • System configuration design • Installation and wiring • I/O memory allocation • Troubleshooting Use this manual together with the <i>Programming Manual</i> (Cat. No. W394).
CS/CJ/NSJ Series Programmable Controllers Operation Manual	W394	CS1G/H-CPU□□H CS1G/H-CPU□□-V1 CS1D-CPU□□H CS1D-CPU□□S CJ1H-CPU□□H-R CJ1G/H-CPU□□H CJ1G-CPU□□P CJ1M-CPU□□ CJ1G-CPU□□ NSJ□-□□□□(B)-G5D NSJ□-□□□□(B)-M3D	Learning about the functions of the CS/CJ-series and NSJ-series PLCs.	The following information is provided on a CS/CJ-series or NSJ-series PLC. <ul style="list-style-type: none"> • Programming • Master function • File memory • Other functions Use this manual together with the <i>Operation Manual</i> (CS-series PLCs: W339, CJ-series PLCs: W393).

Manual name	Cat. No.	Models	Applications	Description
CS/CJ/NSJ Series Instructions Reference Manual	W340	CS1□-CPU-□□□-□□ CJ1□-CPU-□□□-□□□ CJ2H-CPU-□□□-□□□ NSJ□□-□□□□□-□□□	Learning detailed information on programming instructions.	Instructions are described in detail. When programming, use this manual together with the <i>Operation Manual</i> (CS-series PLCs: W339, CJ-series PLCs: W393) and the <i>Programming Manual</i> (W394).
CS/CJ Series Programming Consoles Operation Manual	W341	CQM1H-PRO01 CQM1-PRO01 C200H-PRO27 +CS1W-KS001	Learning the operating procedures of the Programming Consoles.	The operating procedures of the Programming Consoles are described. When programming, use this manual together with the <i>Operation Manual</i> (CS-series PLCs: W339, CJ-series PLCs: W393), the <i>Programming Manual</i> (W394), and the <i>Instructions Reference Manual</i> (W340).
CS/CJ/NSJ Series Communications Commands Reference Manual	W342	CS1G/H-CPU□□H CS1G/H-CPU□□-V1 CS1D-CPU□□H CS1D-CPU□□S CS1W-SCU□□-V1 CS1W-SCB□□-V1 CJ1G/H-CPU□□H CJ1G-CPU□□P CJ1M-CPU□□ CJ1G-CPU□□ CJ1W-SCU□□-V1	Learning detailed specifications on the communications instructions addressed to CS/CJ-series CPU Units and NSJ-series PLCs.	1) C-mode commands and 2) FINS commands are described in detail. Refer to this manual for information on communications commands (C-mode commands and FINS commands) addressed to CPU Units. Note This manual describes communications commands that are addressed to a CPU Unit. The communications path is not relevant. (The communications commands can be sent through the serial communications port of the CPU Unit, the communications port of a Serial Communications Board/Unit, or a communications port on another Communications Unit.)
CJ-series CJ2 CPU Unit Hardware User's Manual	W472	CJ2H-CPU6□-EIP CJ2H-CPU6□ CJ2M-CPU□□	Learning the hardware specifications of CJ2 CPU Units.	The following information is provided on a CJ2 CPU Unit. <ul style="list-style-type: none"> • Introduction and features • Basic system configuration • Part names and functions • Installation and setting procedures • Troubleshooting Use this manual together with the <i>Software User's Manual</i> (Cat. No. W473).
CJ-series CJ2 CPU Unit Software User's Manual	W473	CJ2H-CPU6□-EIP CJ2H-CPU6□ CJ2M-CPU□□	Learning the software specifications of CJ2 CPU Units.	The following information is provided on a CJ2 CPU Unit. <ul style="list-style-type: none"> • CPU Unit operation • Internal memory • Programming • Settings • Functions built into the CPU Unit Use this manual together with the <i>Hardware User's Manual</i> (Cat. No. W472).

Manual name	Cat. No.	Models	Applications	Description
Ethernet Units Operation Manual Construction of Networks	W420	CS1W-ETN21 CJ1W-ETN21	Learning how to use an Ethernet Unit.	Information is provided on the Ethernet Units. Information is provided on the basic setup and FINS communications. Refer to the <i>Communications Commands Reference Manual</i> (Cat. No. W342) for details on FINS commands that can be sent to CS/CJ-series CPU Units when using the FINS communications service.
Ethernet Units Operation Manual Construction of Applications	W421	CS1W-ETN21 CJ1W-ETN21	Learning how to use an Ethernet Unit.	Information is provided on constructing host applications, including functions for sending/receiving mail, socket service, automatic clock adjustment, FTP server functions, and FINS communications.
CS/CJ-series EtherNet/IP™ Units Operation Manual	W465	CJ2H-CPU6□-EIP CJ2M-CPU3□ CS1W-EIP21 CJ1W-EIP21	Learning how to use the built-in EtherNet/IP port of the CJ2 CPU Units.	Information is provided on the built-in EtherNet/IP port and EtherNet/IP Units. Basic settings, tag data links, FINS communications, and other functions are described.
Sysmac Studio Version 1 Operation Manual	W504	SYSMAC-SE2□□□	Learning about the operating procedures and functions of the Sysmac Studio.	The operating procedures of the Sysmac Studio are described.
CX-Programmer Operation Manual	W446	CXONE-AL□□C-V4 CXONE-AL□□D-V4	Learning about the CX-Programmer except for information on function blocks, ST programming, and SFC programming.	The operating procedures of the CX-Programmer are described.

Terminology

Term	Description
HMI	A general term for interface devices that indicates both hardware and software elements. In this manual, "HMI" refers to an OMRON Sysmac-brand product unless otherwise specified.
PT	The hardware elements of the HMI.
NA Series	The NA Series of Programmable Terminals and peripheral devices.
HMI Project	A Sysmac Studio project for an HMI.
NA Unit	An NA-series Programmable Terminal.
Download	Transferring data from the Sysmac Studio to an HMI.
Upload	Transferring the project from an HMI to the Sysmac Studio.
IAG collection	When you provide IAGs, you provide them as IAG collections. IAGs are also imported as IAG collections. An IAG collection contains one or more IAGs.

Revision History

A manual revision code appears as a suffix to the catalog number on the front and back covers of the manual.

Cat. No. V117-E1-06

↑
Revision code

Revision code	Date	Revised content
01	June 2014	Original production
02	October 2014	Made revisions accompanying version upgrade.
03	February 2015	Made revisions accompanying support of HMI Edition.
04	April 2015	Made revisions accompanying support of the NJ/NX Troubleshooter.
05	October 2015	Made revisions accompanying version upgrade.
06	December 2015	Made revisions accompanying version upgrade.

1

Introduction to the NA-series Programmable Terminals

This section describes the features, basic system configuration, specifications, and overall operating procedure of the NA-series Programmable Terminals.

1-1 NA-series Programmable Terminals	1-2
1-1-1 Features	1-2
1-2 System Configurations	1-4
1-2-1 Connecting to the Support Software	1-4
1-2-2 Network Configuration with Other Devices	1-4
1-3 Available Products	1-5
1-3-1 NA Units	1-5
1-3-2 Support Software	1-5
1-3-3 Other Optional Products	1-6
1-4 Specifications	1-7
1-4-1 General Specifications	1-7
1-4-2 Performance Specifications	1-10

1-1 NA-series Programmable Terminals

The NA-series Programmable Terminals represent the next generation of HMIs for industrial applications. They display information on FA manufacturing sites and function as control interfaces while providing safety, reliability, and maintainability. They provide all of the functions of traditional programmable terminals with a clearer, easy-to-use interface.

OMRON offers the new Sysmac Series of control devices designed with unified communications specifications and user interface specifications.

The NA-series Programmable Terminals are Sysmac devices that you can use together with the NJ/NX-series Machine Automation Controllers and the Sysmac Studio Automation Software to achieve optimum functionality and ease of operation.

If you connect an NA-series Programmable Terminal to an NJ/NX-series Controller, all you have to do to specify memory in the Controller is to specify the Controller variables for the objects on the Programmable Terminal screens. This allows you to create screens without being concerned with the memory map of the Controller.

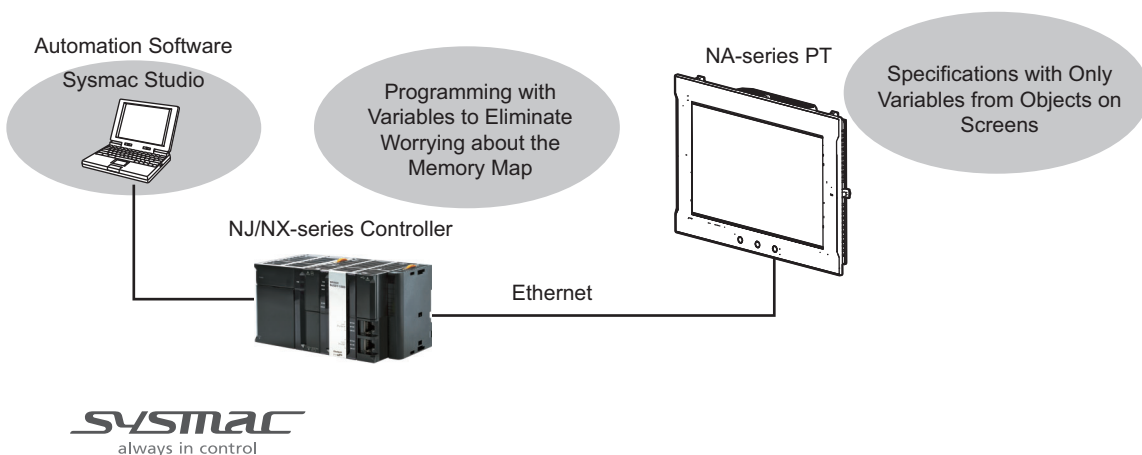

1-1-1 Features

Hardware Features

- **High-resolution Display Panels**

High-resolution display panels are used to more clearly display large amounts of information than was possible with previous OMRON products.

- **Two Ethernet Ports (Standard Feature)**

You can use both Ethernet ports to separate the segment attached to control devices from the segment attached to maintenance devices. Access is possible from both segments at the same time.

You can connect the following devices.

- NJ/NX-series Controllers
- PLCs
- Computers
- Sysmac Studio

- **Standard-feature SD Memory Card Slot**

You can use an SD Memory Card inserted in the NA Unit to automatically transfer the project you created on the Sysmac Studio to the NA Unit, to update the system program in the NA Unit, or to save the log data from the NA Unit.

Software Features

- **Specifications with Variables for Superior Reusability**

If you connect to an NJ/NX-series Controller, all you have to do to specify memory in the Controller is to specify the Controller variables. This allows you to create objects that are not dependent on specific devices or memory maps. This in turn makes the objects much more reusable than they were with previous PTs.

- **Program with Visual Basic**

You can use Microsoft's Visual Basic to program advanced functions that you cannot achieve with standard objects.

- **A Wealth of Security Features**

The many security features of the NA-series PTs include operation authority settings and execution restrictions with IDs.

- **Use the Integrated Development Environment of Sysmac Studio Automation Software**

You use the Sysmac Studio to create applications for the NA-series Programmable Terminals.

The Sysmac Studio provides an integrated development environment that covers not only the NA-series Programmable Terminal, but also the Controller and devices on EtherCAT as well.

You can use consistent procedures for all devices regardless of differences in the devices. The Sysmac Studio supports all phases of Controller application, from page creation and sequence design through debugging, simulations, commissioning, and changes during operation.

- **A Wealth of Simulation Features**

You can perform simulations using a virtual HMI on the Sysmac Studio. And you can also perform online debugging with a virtual NJ/NX-series Controller.

1-2 System Configurations

The section describes the system configurations of an NA-series PT.

1-2-1 Connecting to the Support Software

You can connect the Sysmac Studio to a USB port on the NA Unit with a commercially available USB cable. You can also connect it through an Ethernet cable that is connected to Ethernet port 2 on the NA Unit. Refer to the *NA-series Programmable Terminal Software User's Manual (V118)* for details on the connection configuration with the Sysmac Studio.

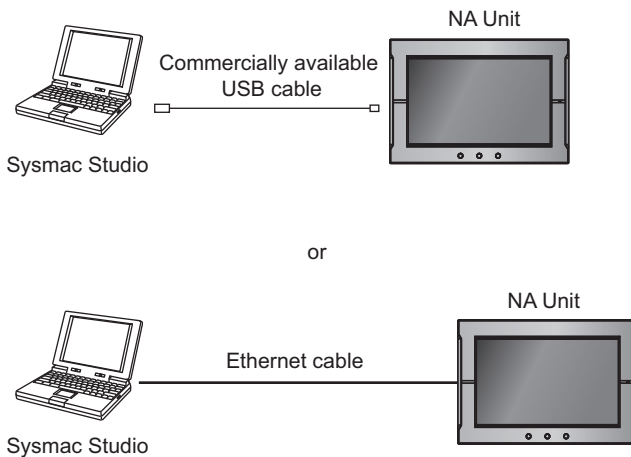

1-2-2 Network Configuration with Other Devices

With an NA-series PT, you use Ethernet to connect to connected devices.



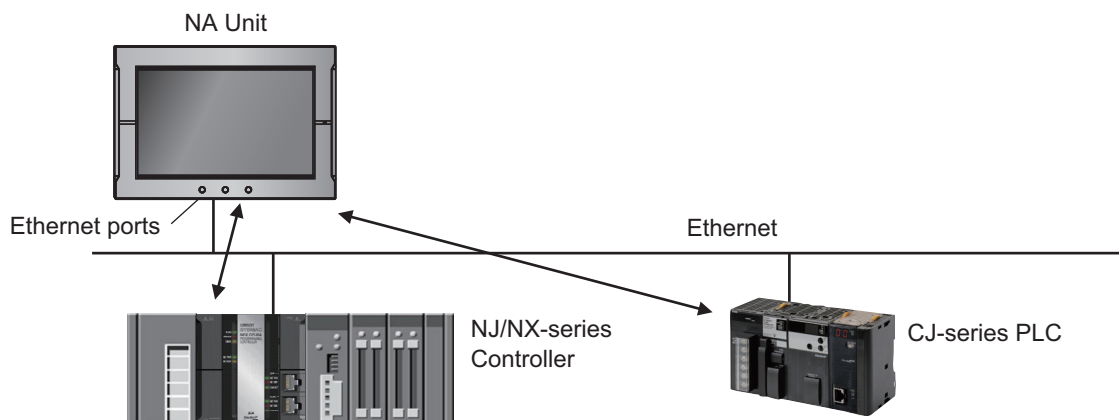

You can connect an NJ/NX-series Controller, PLC, or other device to Ethernet port 1 on the NA Unit with an Ethernet cable.



1-3 Available Products

This section provides tables of the NA Units and optional products. Refer to *1-4 Specifications* on page 1-7 for detailed specifications.

1-3-1 NA Units

Model	Case		Display panel	Data capacity	Power consumption	Weight
	Appearance	Color				
NA5-15W101S NA5-15U101S		Silver	15.4 inches	256 MB	47 W max.	3.2 kg max.
NA5-15W101B NA5-15U101B		Black				
NA5-12W101S NA5-12U101S		Silver	12.1 inches		45 W max.	2.3 kg max.
NA5-12W101B NA5-12U101B		Black				
NA5-9W001S NA5-9U001S		Silver	9.0 inches		40 W max.	1.7 kg max.
NA5-9W001B NA5-9U001B		Black				
NA5-7W001S NA5-7U001S		Silver	7.0 inches		35 W max.	1.3 kg max.
NA5-7W001B NA5-7U001B		Black				

1-3-2 Support Software

You use the Sysmac Studio to create applications for NA-series PTs and to debug them.

Name	Model	Specifications
Sysmac Studio Standard Edition	SYSMAC-SE□□□	This software is used to create and debug applications for NA-series PTs. You can also use the Sysmac Studio to perform programming and simulations for NJ/NX-series Controllers because it provides an integrated development environment for all Sysmac devices.
Sysmac Studio HMI Edition	SYSMAC-HE001L	You can use this edition only for the NA-series PTs.

1-3-3 Other Optional Products

SD Memory Cards

Model	Appearance	Capacity
HMC-SD291		2 GB
HMC-SD491		4 GB

USB Memory Devices

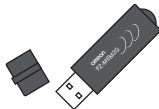
Model	Appearance	Capacity
FZ-MEM2G		2 GB
FZ-MEM8G		8 GB

Other Products

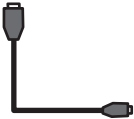
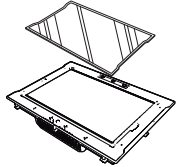
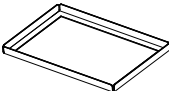
Name	Model	Appearance	Specifications
Battery Set	CJ1W-BAT01		This is the battery for backup. This Battery is provided as an accessory. It is used to back up the clock information in the NA Unit.
Cable for USB port (to connect the Sysmac Studio)	Commercially available USB cable		USB 2.0 (or 1.1) cable (A connector - B connector), 5.0 m max.
Anti-reflection Sheets	NA-15WKBA04 NA-12WKBA04 NA-9WKBA04 NA-7WKBA04		Attach a Sheet to the screen to suppress the diffused reflections and protect against damage and dirt.
High-pressure Waterproof Attachment (PWA)	NA-15WATW01 NA-12WATW01 NA-9WATW01 NA-7WATW01		This metal frame is for high-pressure waterproofing. Install it to conform to UL Type 4X standards.

1-4 Specifications

This section gives the hardware specifications of the NA-series PTs.

1-4-1 General Specifications

Item	Specification			
	NA5-15W□□□□ NA5-15U□□□□	NA5-12W□□□□ NA5-12U□□□□	NA5-9W□□□□ NA5-9U□□□□	NA5-7W□□□□ NA5-7U□□□□
Rated supply voltage	24 VDC			
Allowable power supply voltage range	19.2 to 28.8 VDC (24 VDC ±20%)			
Allowable momentary power interruption time	Operation for momentary power interruption is not specified.			
Power consumption	47 W max.	45 W max.	40 W max.	35 W max.
Ambient operating temperature	0 to 50°C ^{*1*2}			
Ambient storage temperature	-20 to 60°C ^{*3}			
Ambient operating humidity	10 to 90% ^{*2} Must be no condensation.			
Atmosphere	Must be free from corrosive gases.			
Pollution degree	2 or less: JIS B 3502, IEC 61131-2			
Noise immunity	2 kV on power supply line (Conforms to IEC 61000-4-4.)			
Vibration resistance (during operation)	Conforms to IEC 60068-2-6. 5 to 8.4 Hz with 3.5-mm half amplitude and 8.4 to 150 Hz with 9.8 m/s ² for 100 minutes each in X, Y, and Z directions (Time coefficient of 10 minutes × coefficient factor of 10 = total time of 100 min.)			
Shock resistance (during operation)	Conforms to IEC 60028-2-27. 147 m/s ² 3 times each in X, Y, and Z directions			
Dimensions	420 × 291 × 69 mm (W × H × D)	340 × 244 × 69 mm (W × H × D)	290 × 190 × 69 mm (W × H × D)	236 × 165 × 69 mm (W × H × D)
Panel cutout dimensions	392 ⁺¹ ₀ × 268 ⁺¹ ₀ mm (horizontal × vertical) Panel thickness: 1.6 to 6.0 mm	310 ⁺¹ ₀ × 221 ⁺¹ ₀ mm (horizontal × vertical) Panel thickness: 1.6 to 6.0 mm	261 ⁺¹ ₀ × 166 ⁺¹ ₀ mm (horizontal × vertical) Panel thickness: 1.6 to 6.0 mm	197 ^{+0.5} ₀ × 141 ^{+0.5} ₀ mm (horizontal × vertical) Panel thickness: 1.6 to 6.0 mm
Weight	3.2 kg max.	2.3 kg max.	1.7 kg max.	1.3 kg max.
Degree of protection	Front-panel controls: IP65 oil-proof type, UL Type 4X (at initial state) To reinstall the NA Unit in a panel, contact your OMRON representative for replacement of the rubber packing.			
Battery life	Battery life: 5 years at 25°C The RTC will be backed up for 5 days after the battery runs low. The RTC will be backed up by a super capacitor for 5 minutes after removing the old battery. (This assumes that the power is first turned ON for at least 5 minutes and then turned OFF.)			

Item	Specification			
	NA5-15W□□□□ NA5-15U□□□□	NA5-12W□□□□ NA5-12U□□□□	NA5-9W□□□□ NA5-9U□□□□	NA5-7W□□□□ NA5-7U□□□□
International standards*4	UL 508/CSA standard C22.2 No.142*5 EMC Directive (2004/108/EC) EN 61131-2:2007 Shipbuilding standards LR, DNV, and NK IP65 oil-proof, UL Type 4X (front panel only) ANSI 12.12.01 Class 1 Division 2/CSA standard C22.2 No. 213-M1987 (R2013) RoHS Directive (2002/95/EC) KC Standards KN 61000-6-2:2012-06 for EMS and KN 61000-6-4:2012-06 for EMI RCM			

- *1. The ambient operating temperature is subject to the following restrictions, depending on the mounting angle.
- The ambient operating temperature is 0° to 40°C when the mounting angle is 0° or more and less than 45° to the horizontal.
 - The ambient operating temperature is 0° to 50°C when the mounting angle is 45° or more and 90° or less to the horizontal.
 - The ambient operating temperature is 0° to 50°C when the mounting angle is 90° or more and 135° or less to the horizontal.

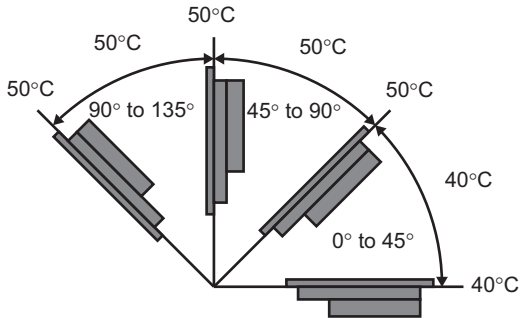

- *2. Use the PT within the following temperature and humidity ranges.

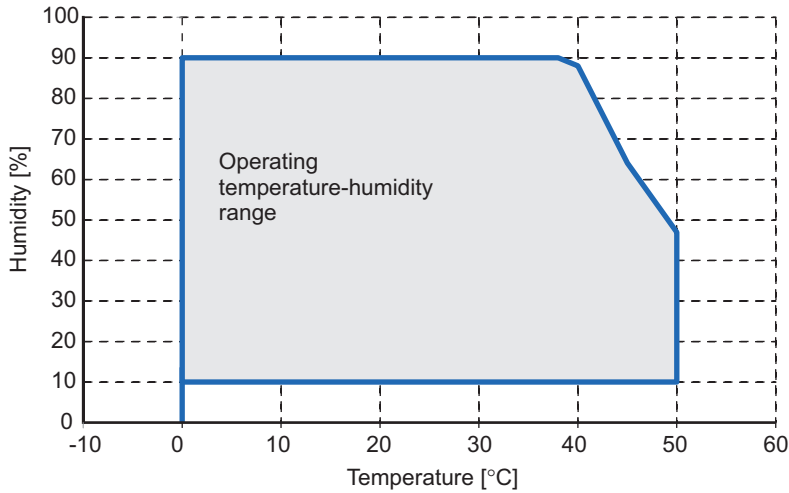

*3. Store the PT within the following temperature and humidity ranges.

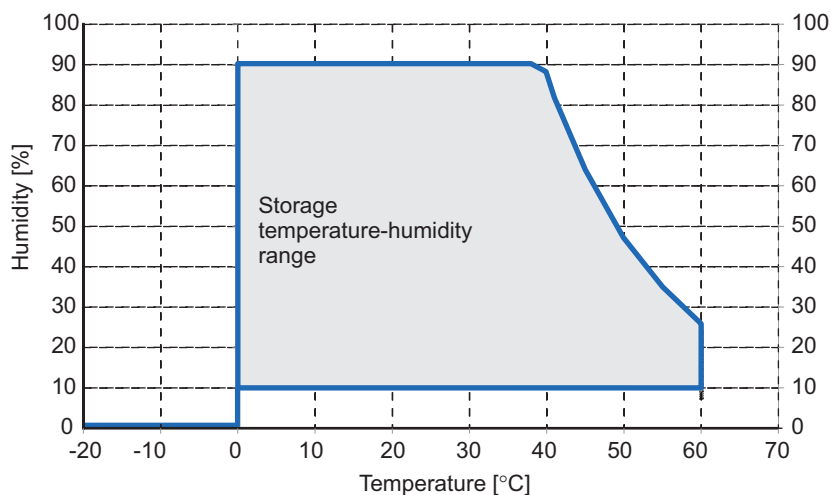

*4. Check with your OMRON representative or refer to the following OMRON website for the latest information on the applicable standards for each model: www.ia.omron.com.

*5. Use power supply Class 2 to conform to UL Standards.

1-4-2 Performance Specifications

Display

Item		Specification			
		NA5-15W□□□□	NA5-12W□□□□	NA5-9W□□□□	NA5-7W□□□□
Display panel ^{*1}	Display device	TFT LCD			
	Screen size	15.4 inches	12.1 inches	9.0 inches	7.0 inches
	Resolution	1,280 × 800 dots (horizontal × vertical)		800 × 480 dots (horizontal × vertical)	
	Colors	16,770,000 colors			
	Effective display area	331 × 207 mm (horizontal × vertical)	261 × 163 mm (horizontal × vertical)	197 × 118 mm (horizontal × vertical)	152 × 91 mm (horizontal × vertical)
	View angles	Left: 60°, Right: 60°, Top: 60°, Bottom: 60°			
Backlight ^{*2}	Life	50,000 hours min. ^{*3}			
	Brightness adjustment	200 levels			
Front panel indicators ^{*4}	RUN	Lit green: Normal operation			
		Lit red: Error			

*1. There may be some defective pixels in the display. This is not a fault as long as the numbers of defective light and dark pixels fall within the following standard ranges.

Model	Standard range
NA5-15W□□□□	Number of light and dark pixels: 10 or less. (There must not be 3 consecutive light/dark pixels.)
NA5-12W□□□□	
NA5-9W□□□□	
NA5-7W□□□□	

*2. The backlight can be replaced at an OMRON maintenance base.

*3. This is the estimated time before brightness is reduced by half at room temperature and humidity. The life expectancy is drastically shortened if PT is used at high temperatures.

*4. The brightness of the front panel indicators is also adjustable when you adjust the brightness of the backlight.

Operation

Item		Specification			
		NA5-15W□□□□	NA5-12W□□□□	NA5-9W□□□□	NA5-7W□□□□
Touch panel	Method: Analog resistance membrane (pressure sensitive)				
	Resolution: 16,384 × 16,384				
	Life: 1,000,000 operations				
Function keys ^{*1}	3 inputs (capacitance inputs)				

*1. Each function key has blue indicator. The brightness of the function key indicators is also adjustable when you adjust the brightness of the backlight.

Data Capacity

Item		Specification			
		NA5-15W□□□□	NA5-12W□□□□	NA5-9W□□□□	NA5-7W□□□□
User data capacity	256 MB				

External Interfaces

Item		Specifications (Same for all models.)
Ethernet ports	Applications	Port 1: Connecting to anything other than the Sysmac Studio, e.g., device connections and VNC clients Port 2: Connecting to the Sysmac Studio in addition to the applications of port 1.
	Number of ports	2 ports
	Compliant standards	IEEE 802.3i (10BASE-T), IEEE 802.3u (100BASE-TX), and IEEE 802.3ab (1000Base-T)
	Transmission media	Shielded twisted-pair (STP) cable: Category 5, 5e, or higher
	Transmission distance	100 m
	Connector	RJ-45 8P8C modular connector
USB host ports	Applications	USB Memory Device, keyboard, or mouse
	Number of ports	2 ports
	Compliant standards	USB 2.0
	Transmission distance	5 m max.
	Connector	Type-A connector
USB slave port	Applications	Sysmac Studio connection
	Number of ports	1 port
	Compliant standards	USB 2.0
	Transmission distance	5 m max.
	Connector	Type-B connector
Serial port ^{*1}	Applications	Device Connection
	Number of ports	1 port
	Compliant standards	RS-232C
	Transmission distance	15 m max.
	Connector	D-SUB 9-pin female connector
SD Memory Card slot	Applications	To transfer or store the project or to store log data.
	Number of slots	1 slot
	Compliant standards	SD/SDHC
Expansion Unit connector ^{*1}	Applications	Expansion Unit
	Quantity	1

*1. The serial port and Expansion Unit connector are for future expansion.

2

Configuration Units

This section describes the basic system configuration and devices used for NA-series Programmable Terminals.

2-1 NA Units	2-2
2-1-1 Components and Functions	2-2
2-2 SD Memory Cards	2-9
2-2-1 Models and Specifications	2-9
2-2-2 Applications	2-9
2-2-3 Installing and Removing	2-9
2-3 USB Memory Devices	2-11
2-3-1 Models and Specifications	2-11
2-3-2 Applications	2-11
2-3-3 Installing and Removing	2-11
2-4 Support Software	2-13
2-4-1 Connection Methods	2-13



2-1 NA Units

This section describes the names and functions of NA Unit parts and installation methods and provides other information.

2-1-1 Components and Functions

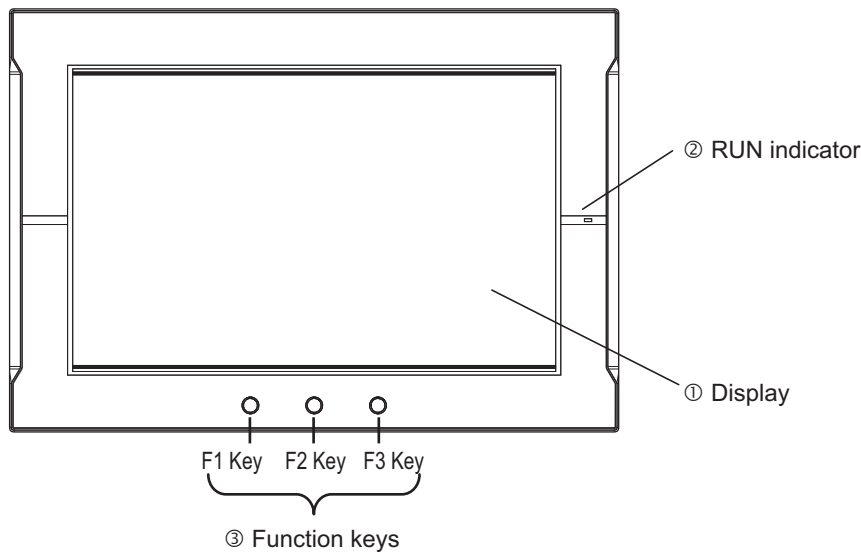
Front Panel



No.	Name	Description
①	Display	The entire display is a touch panel that also functions as an input device.
②	RUN indicator	The status of the indicator changes according to the status of the NA Unit.
③	Function keys	<p>There are three function keys: F1, F2, and F3.</p> <p>  : F1 Key,  : F2 Key,  : F3 Key </p> <p>You can use the function keys as execution conditions for the actions for global or page events.</p> <p>You can also use the function keys for interlocks.</p>

● Display

You can perform input operations with the touch panel on the front surface of the NA Unit. You can tap buttons on the touch panel to change the display or to send data to connected devices.

WARNING

Never press two points or more on the touch panel of the NA Unit at a time. Touching two points or more interrupts normal touch panel operations.





Precautions for Safe Use

- Do not press the touch panel with a force greater than 30 N.
 - The deterioration over time may cause the touch points to move on the touch panel. Calibrate the touch panel periodically.
 - A touch position detection error of approximately 20 pixels may occur due to the precision of the touch panel. Always take this into account when positioning objects on the panel so adjoining objects will not be activated by mistake.
 - Confirm the safety of the system before pressing the touch panel.
 - Do not accidentally press the touch panel when the backlight is not lit or when the display does not appear or is too dark to identify visually.
 - Signals from the touch panel may not be entered if the touch panel is pressed consecutively at high speed. Make sure to go on the next operation after confirming that the NA Unit has detected the input of the touch panel.
-



Precautions for Correct Use

- If you touch the touch panel where there is no object and then slide your finger over to an object, the object will not be activated. To activate an object, remove your finger from the touch panel and then touch the object securely.
 - To ensure accurate input operations, use the size of a finger as the basis for the minimum size of objects.
-

● RUN Indicator Status

You can use the status of the RUN indicator to check the status of the NA Unit. Refer to *5-1-1 Checking NA Unit Status* on page 5-2 for details.

● Function Keys

You can specify the action to execute when a function key is tapped.

You can specify the following actions: calling a user-defined subroutine, prohibiting touch panel inputs, changing the backlight brightness, displaying a PDF file, etc.

To execute these functions, you assign the function key operations to global events or object events and then specify the corresponding actions.

Refer to the *NA-series Programmable Terminal Software User's Manual* (Cat. No. V118) for details.

Back Panel

• Back Panel

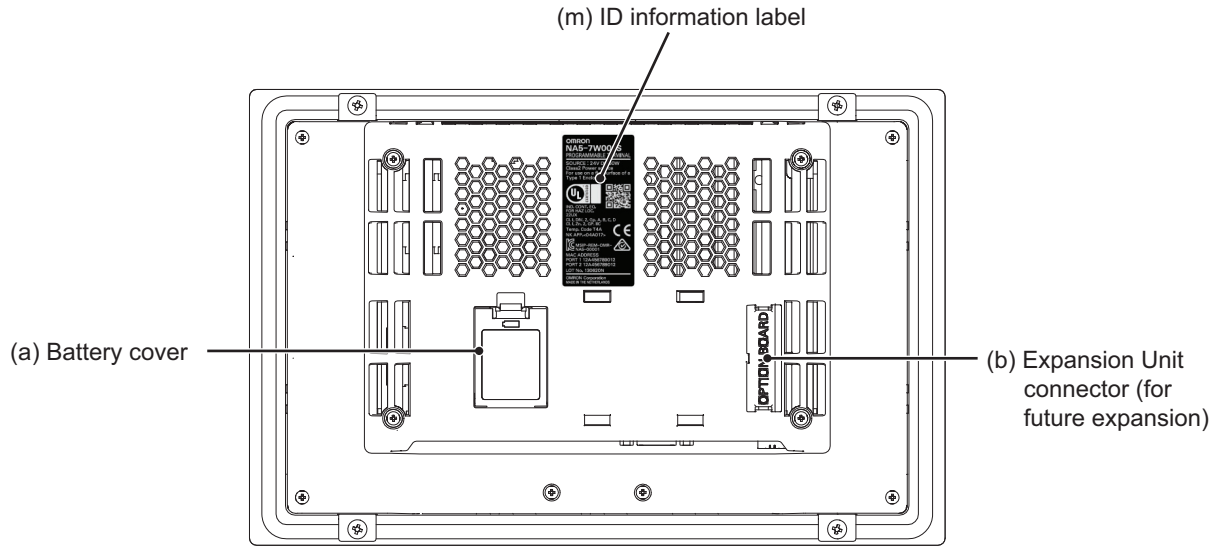

• Bottom Panel

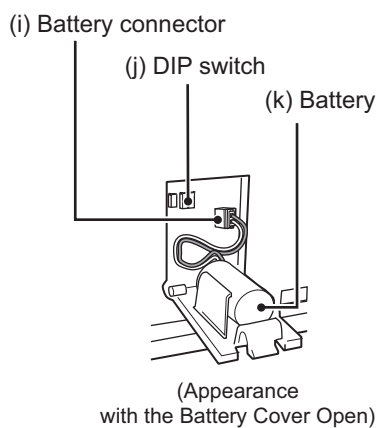
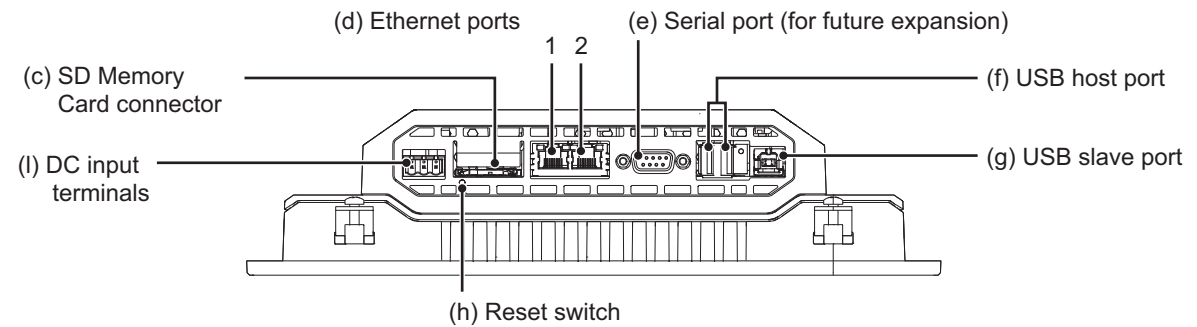

No.	Name	Description
(a)	Battery cover	Open this cover to replace the Battery.
(b)	Expansion Unit connector*1	For future expansion.
(c)	SD Memory Card connector	Insert an SD Memory Card here.
(d)	Ethernet port 1	Connect a device other than the Sysmac Studio.
	Ethernet port 2	Connect mainly the Sysmac Studio.
(e)	Serial port*1	For future expansion.
(f)	USB host port	Connect this port to a USB Memory Device, mouse, etc.
(g)	USB slave port	Connect the Sysmac Studio or other devices.
(h)	Reset switch	Use this switch to reset the NA Unit.
(i)	Battery connector	Connect the connector on the backup Battery here.
(j)	DIP switch*1	For future expansion. (The DIP switch is on a PCB that is accessed by opening the Battery cover.) Do not change any of the factory settings of the pins on the DIP switch.
(k)	Battery	This is the battery to backup the clock information in the NA Unit.
(l)	DC input terminals	These are the power supply terminals. Connect the accessory power supply connector and supply power.
(m)	ID information label	You can check the ID information of the NA Unit.

*1. The DIP switch, Expansion Unit connector, and serial port are for future expansion.



Precautions for Safe Use

Confirm the safety of the system before turning ON or OFF the power supply, or pressing the reset switch.

● Battery

The following Battery is provided as a standard feature.

Model	Appearance	Specifications
CJ1W-BAT01		<p>Effective life (i.e., maximum life expectancy): 5 years</p> <p>The following data is retained during power interruptions.</p> <ul style="list-style-type: none"> • Time data

● **Power Supply Connector Pin Arrangement**

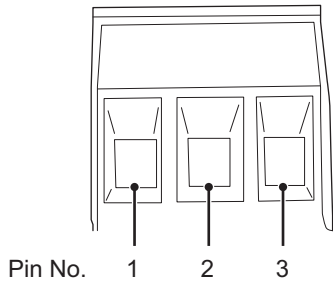

Pin No.	Signal name	Name
1	+24 V	+24-V input
2	0 V	0 V
3	FG	Functional ground

● **Reset Switch**

Use a precision screwdriver or similar device with a diameter of less than 2.4 mm. The reset switch performs the same function as cycling the power supply.

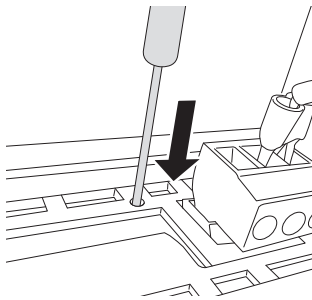

● **Ethernet Ports**

- Port Pin Arrangement and Indicator Locations

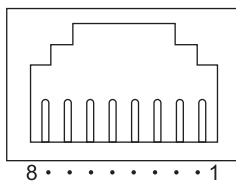
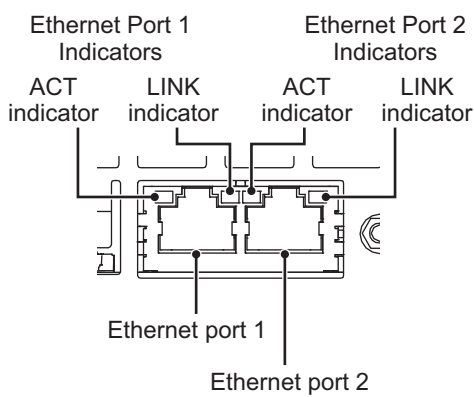

- Connecting Devices That Support IEEE 802.3i (10BASE-T) or IEEE 802.3u (100BASE-TX)

Pin No.	Signal name	Name
1	TD+	Twisted-pair output (differential output)
2	TD-	Twisted-pair output (differential output)
3	RD+	Twisted-pair input (differential input)
4	BI D+	Protection circuit
5	BI D-	Protection circuit
6	RD-	Twisted-pair input (differential input)
7	BI D+	Protection circuit
8	BI D-	Protection circuit

- Connecting Devices That Support IEEE 802.3ab (1000Base-T)

Pin No.	Signal name	Name
1	TRD0+	Send/receive data 0+
2	TRD0-	Send/receive data 0-
3	TRD1+	Send/receive data 1+
4	TRD2+	Send/receive data 2+
5	TRD2-	Send/receive data 2-
6	TRD1-	Send/receive data 1-
7	TRD3+	Send/receive data 3+
8	TRD3-	Send/receive data 3-

If you use a cable with a hood or boot, make sure that the mating length is at least 15 mm, as shown in the following figure.

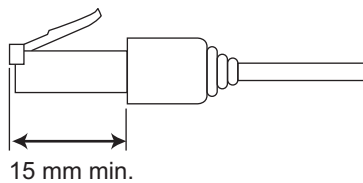

- Ethernet Port Indicators

Indicator	Color	Status	Description
LINK	---	Not lit.	A link was not established. <ul style="list-style-type: none"> The cable is not connected. The power supply is OFF or the NA Unit was reset.
	Green	Lit.	The link was established.
ACT	---	Not lit.	The link is on standby.
	Orange	Flashing.	Data is being sent or received.

● ID Information Label

You can check the ID information of the NA Unit with the ID information label on the back of the NA Unit.

An example is shown below. The label varies with the model and applicable standards.

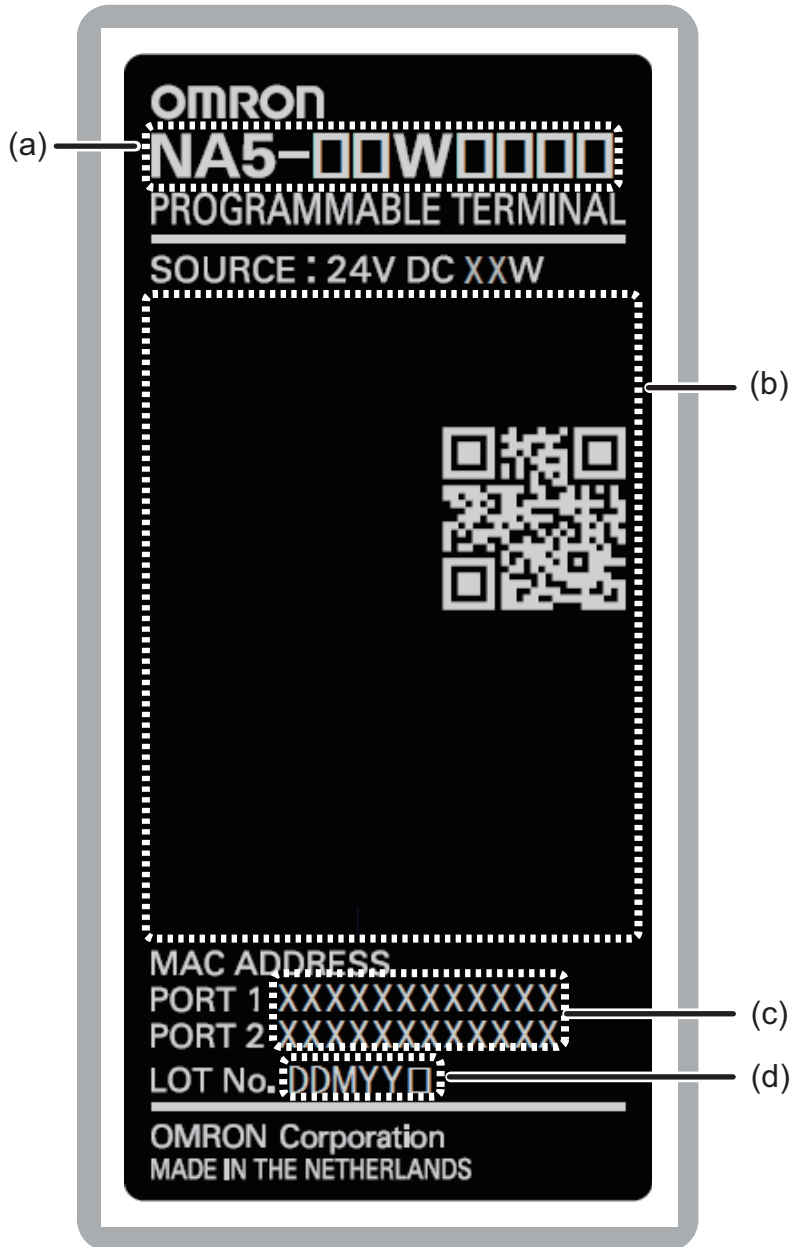

No.	Name	Description
(a)	Model	Gives the model of the NA Unit.
(b)	Standards	Gives the standards for which the NA Unit is certified.
(c)	MAC addresses	Give the MAC addresses of the Ethernet ports.
(d)	Lot number	Gives the lot number of the NA Unit. DDMYY□: Lot number, □: For use by OMRON M is 1 to 9 for January to September, X for October, Y for November, and Z for December.

2-2 SD Memory Cards

This section describes how to use an SD Memory Card to transfer the project or save log data.

2-2-1 Models and Specifications

SD and SDHC memory cards are supported, but use the OMRON-specified SD Memory Cards. (Refer to 1-3-3 *Other Optional Products* on page 1-6.) OMRON is not responsible for the operation, performance, or write life of any other memory card.



Additional Information

Write Protection Key

You will not be able to write to the SD Memory Card if the key is set to the LOCK position. (Use this setting to prevent overwriting.)

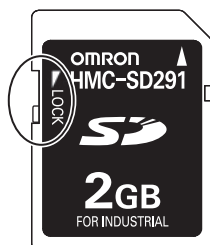

2-2-2 Applications

You can use the SD Memory Card for the following applications.

- Automatically transferring the project data (which includes the screen data) created on the Sysmac Studio to an HMI
- Updating the HMI system program
- Recording log data (data log and user alarms)

2-2-3 Installing and Removing

This section describes the methods to install and remove an SD Memory Card.

Refer to the *NA-series Programmable Terminal Software User's Manual* (Cat. No. V118) for information on executing actions and information on system-defined variables.

Before Using an SD Memory Card

Observe the following precautions while an SD Memory Card is inserted.

- Before you remove the SD Memory Card, execute the EjectSDMemory action and check the `_HMI_CanEjectSDCard` system-defined variable to make sure that the power supply to the SD Memory Card is stopped.
- Before you turn OFF the HMI power supply, execute the EjectSDMemory action and check the `_HMI_CanEjectSDCard` system-defined variable to make sure that the power supply to the SD Memory Card is stopped.

- Never insert the SD Memory Card facing the wrong way. If the SD Memory Card is inserted forcibly, it may become unusable.
- To format the SD Memory Card (e.g., to delete all of the data), use the SD Formatter for SD/SDHC/SDXC provided by the SD Association.
SD Association: <https://www.sdcard.org/>
- The SD Memory Card uses flash memory, and so its service life is limited. When the end of the SD Memory Card's service life approaches, the ability to write data is lost, and data is sometimes not retained after writing. The service life depends on the size of the data that is written and on the ambient temperature. For the unlikely event that data is lost, it is recommended to periodically back up data.

Installing the SD Memory Card

- 1** Insert the SD Memory Card into the slot on the back of the NA Unit with the label facing upward when viewed from the back of the NA Unit.

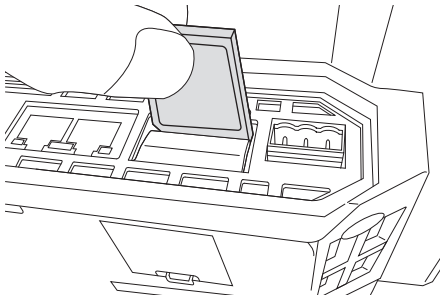

- 2** Push the SD Memory Card securely into the compartment.

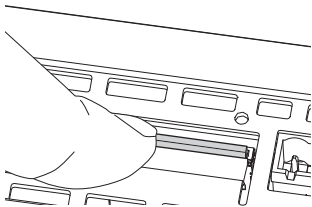

Removing the SD Memory Card

- 1** Execute the EjectSDMemory action.
- 2** Use the `_HMI_CanEjectSDCard` system-defined variable to confirm that the power supply to the SD Memory Card is stopped, and then remove the SD Memory Card.

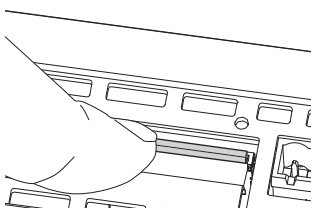

The SD Memory Card will be ejected from the compartment.

- 3** Pull out the SD Memory Card.

2-3 USB Memory Devices

This section describes how to use a USB Memory Device to transfer the project or save log data.

2-3-1 Models and Specifications

USB Memory Devices that comply with the USB 2.0 standard are supported, but use one of the USB Memory Devices specified by OMRON. (Refer to *1-3-3 Other Optional Products* on page 1-6.) OMRON is not responsible for the operation, performance, or write life of any other USB Memory Device.

2-3-2 Applications

You can use the USB Memory Device for the following applications.

- Automatically transferring the project data (which includes the screen data) created on the Sysmac Studio to the HMI
- Updating the HMI system program
- Recording log data (data log and user alarms)

2-3-3 Installing and Removing

This section describes methods to install and remove an USB Memory.

Refer to the *NA-series Programmable Terminal Software User's Manual* (Cat. No. V118) for information on subroutines.



Precautions for Correct Use

You can connect only one USB memory device at the same time.

Before Using a USB Memory Device

Observe the following precautions while the USB Memory Device is being accessed.

- Before you remove the USB Memory Device, execute EjectUSBDevice in a subroutine.
- Before you turn OFF the power supply to the HMI, execute EjectUSBDevice in a subroutine.
- Never insert the USB Memory Device facing the wrong way.
If the USB Memory Device is inserted forcibly, it may become unusable.
- To format a USB Memory Device (e.g., to delete all of the data), use a Windows formatting utility and format to FAT32.
- The USB Memory Devices use flash memory, and so their service life is limited. When the end of the USB Memory Device's service life approaches, the ability to write data is lost, and data is sometimes not retained after writing. The service life depends on the size of the data that is written and on the ambient temperature. For the unlikely event that data is lost, it is recommended to periodically back up data.

Installing the USB Memory Device

- 1 Insert the USB Memory Devices into the USB host port on the back of the NA Unit.

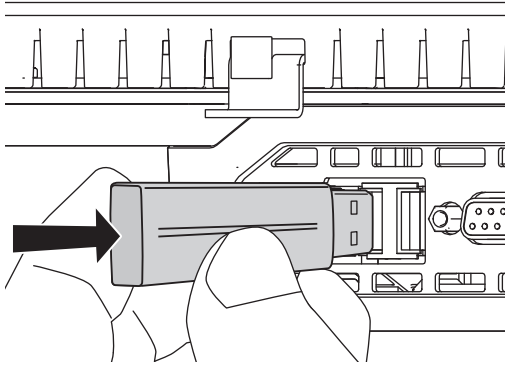

- 2 Push the USB Memory Device all of the way in.

Removing the USB Memory Device

- 1 Execute EjectUSBDevice in a subroutine and then remove the USB Memory Device.

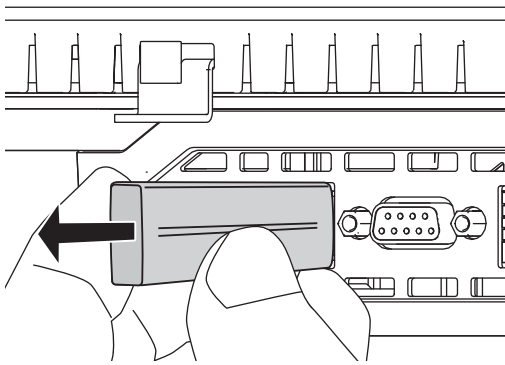

2-4 Support Software

This Sysmac Studio is used to create, debug, and maintain applications for NA-series Programmable Terminals.

2-4-1 Connection Methods

With an NA-series Programmable Terminal, you can connect the Sysmac Studio online in the following ways.

Connecting with USB

Use a commercially available USB cable for a USB connection.

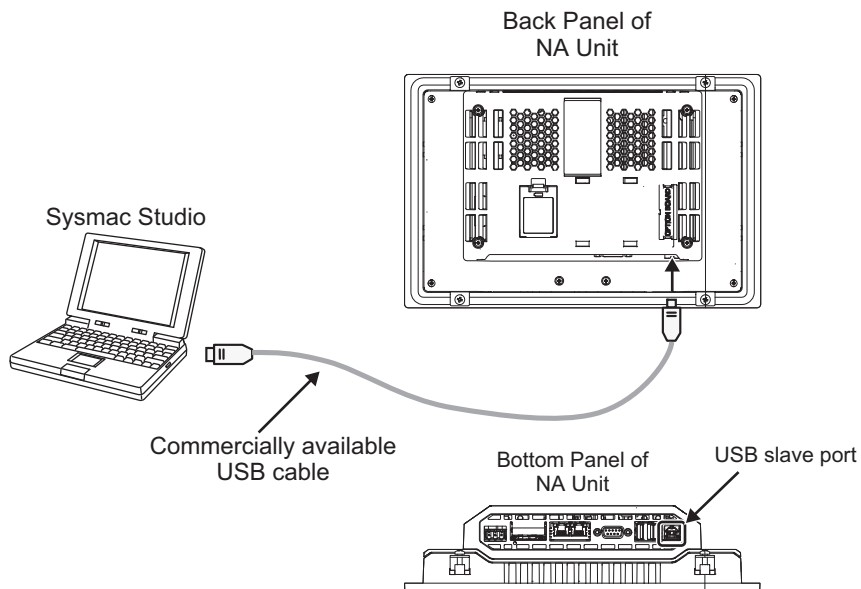

You do not need to specify the connected device on the Sysmac Studio.

Connecting with Ethernet

You can use a direct connection or connect through an Ethernet switch by connecting to Ethernet port 2 on the NA Unit.

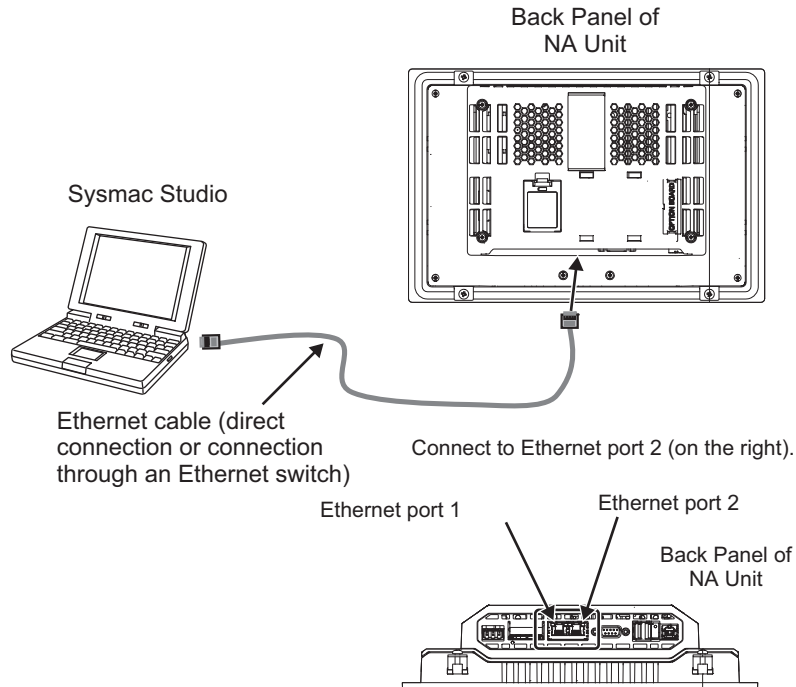

- Connect the Sysmac Studio to Ethernet port 2.
- The IP address and connection device do not need to be specified at the Sysmac Studio. Select the *Direct Connection with Sysmac Studio* Check Box under **HMI Settings – TCP/IP Settings** and then connect to Ethernet port 2.
- You can make the connection either with or without a switching hub.
- The Ethernet port on the NA Unit supports Auto-MDI, so you can use either a cross cable or a straight cable if you connect directly to the computer.

Refer to the *NA-series Programmable Terminal Device Connection User's Manual* (Cat. No. V119) for information on recommended Ethernet switches and connection details.

3

Installation and Wiring

This section describes how to install and wire an NA Unit.

3-1	Processing at Power ON and Power OFF	3-2
3-1-1	Power ON Operation	3-2
3-1-2	Power OFF Operation	3-2
3-2	Fail-safe Measures	3-3
3-2-1	Power ON Sequence	3-3
3-3	Installing NA Units	3-4
3-3-1	Installation in a Control Panel	3-4
3-4	Wiring Methods	3-9
3-4-1	Power Supply Wiring	3-9
3-4-2	Wiring the Ethernet Port	3-13
3-4-3	Wiring the Serial Port	3-13
3-5	Control Panel Installation	3-14
3-5-1	Temperature	3-14
3-5-2	Humidity	3-15
3-5-3	Vibration and Shock	3-16
3-5-4	Atmosphere	3-16
3-5-5	Electrical Environment	3-17
3-5-6	Grounding	3-19

3-1 Processing at Power ON and Power OFF

WARNING

Do not attempt to disassemble, repair, or modify the NA Unit. It may cause NA Unit to lose its safety function.

Do not attempt to take the NA Unit apart and do not touch the product inside while the power is being supplied. Otherwise it may result in electric shock.



3-1-1 Power ON Operation



Precautions for Safe Use

Confirm the safety of the system before turning ON or OFF the power supply, or pressing the reset switch.

Operation until Operation Ready Status

The NA Unit will enter operation-ready status after the following time elapses once power supply starts.

- **NA Unit Startup Time at Power ON**

It takes approximately 30 seconds for the NA Unit to start up. The startup time is affected by the contents of the project and the presence or absence of an SD Memory Card.

3-1-2 Power OFF Operation

WARNING

NA Unit operation may not be dependable for momentary power interruptions.

Implement countermeasures for momentary power interruptions at the power supply.



Precautions for Power Interruptions

Observe the following precautions when power is interrupted.

Item	Description
SD Memory Card access in progress	Any write data may be lost.
Transferring the project or other data in process	The operation is interrupted. As a result, an error will occur the next time that the power is turned ON. Transfer the data again.

3-2 Fail-safe Measures

WARNING

Provide safety measures in external circuits to ensure safety in the system if an abnormality occurs due to malfunction of the NA Unit or due to other external factors affecting operation. Not doing so may result in serious accidents due to incorrect operation.



The circuits associated with safety measures, such as emergency stop circuits, interlock circuits, and limit circuits, must be provided in external control circuits.

External safety measures must be provided to ensure the safe operation of the system from when the power supply is turned ON until execution of the project starts.

Unintended operation may occur when an error occurs in memory or other data. As a counter-measure for such problems, external safety measures must be provided to ensure safe operation of the system.

Provide measures in the communications system and in the user program to ensure safety in the overall system even if errors or malfunctions occur.

You must implement fail-safe measures to provide sufficient protection in the event that abnormal signals or problems occur as the result of broken signal lines or momentary power interruptions. Not doing so may result in serious accidents due to incorrect operation.

3-2-1 Power ON Sequence

We recommend the following sequence for turning ON the power supplies.

- (1) Ethernet switches and other network devices
- (2) Connected devices
- (3) NA Unit

If you turn ON the power supply to the connected device after you turn ON the power supply to the NA Unit, an error may occur depending on system settings.



Precautions for Safe Use

It takes up to approximately 30 seconds for execution of the HMI project to start after the power is turned ON. External communications are also not performed during this period. Implement fail-safe measures so that connected devices do not operate incorrectly, including measures to check the execution of the HMI project.

3-3 Installing NA Units

This section describes how to install an NA Unit.



Precautions for Correct Use

- Follow the instructions in this manual to correctly perform installation.
- Do not install or store the NA Unit in any of the following locations:
 - Locations subject to severe changes in temperature
 - Locations subject to temperatures or humidity outside the range specified in the specifications
 - Locations subject to condensation as the result of high humidity
 - Locations subject to corrosive or flammable gases
 - Locations subject to strong shock or vibration
 - Locations outdoors subject to direct wind and rain
 - Locations subject to strong ultraviolet light
 - Locations subject to dust
 - Locations subject to direct sunlight
 - Locations subject to splashing oil or chemicals
- Take appropriate and sufficient countermeasures when installing systems in the following locations:
 - Locations subject to static electricity or other forms of noise
 - Locations subject to strong electric field or magnetic field
 - Locations close to power supply lines
 - Locations subject to possible exposure to radioactivity
- Mounting Panel
 - To conform to UL Type 1 standards, the mounting panel thickness must be 1.6 to 6.0 mm.
 - To conform to UL Type 4X standards, the thickness must be 1.6 to 4.5 mm.
To conform to UL Type 4X standards, always use the NA5-□□W□□□□ with a High-pressure Waterproof Attachment (PWA). If you do not use a PWA, there is a risk of water entry, which may cause severe equipment damage.
Do not use the NA Unit outdoors.
 - Tighten the Mounting Brackets evenly to a torque of between 0.5 and 0.6 N·m to maintain water and dust resistance. If the tightening torque exceeds the specified range or the tightening is not even, deformation of the front panel may occur. Make sure the panel is not dirty or warped, that the front surface is smooth, and that the panel is strong enough to hold the NA Unit.

3-3-1 Installation in a Control Panel

Installation in a Control Panel

The NA Unit is installed by embedding it in a control panel. Panel Mounting Brackets and a Phillips screwdriver are required to mount the NA Unit. The required number of Panel Mounting Brackets are included with the NA Unit.

To conform to UL Type 4X standards, the thickness must be 1.6 to 4.5 mm. To conform to UL Type 4X standards, always use the NA5-□□W□□□□ with a High-pressure Waterproof Attachment (PWA). If you do not use a PWA, there is a risk of water entry, which may cause severe equipment damage.

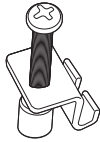

Panel Mounting Bracket

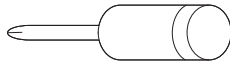

Phillips screwdriver

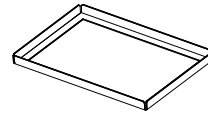

High-pressure Waterproof Attachment (PWA)

Use the following installation procedure.

- 1 Open a hole in which to embed the NA Unit with the following dimensions and insert the NA Unit from the front side of the panel.

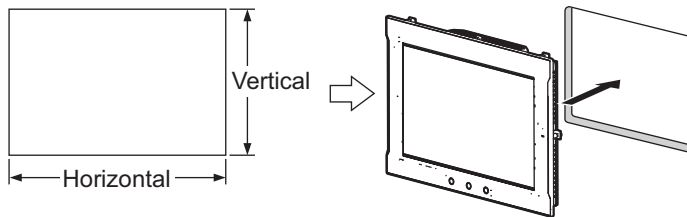

Recommended panel thickness: 1.6 to 6.0 mm

Model	Dimensions
NA5-15W□□□□	392 ^{+1/-0} × 268 ^{+1/-0} mm (horizontal × vertical)
NA5-12W□□□□	310 ^{+1/-0} × 221 ^{+1/-0} mm (horizontal × vertical)
NA5-9W□□□□	261 ^{+1/-0} × 166 ^{+1/-0} mm (horizontal × vertical)
NA5-7W□□□□	197 ^{+0.5/-0} × 141 ^{+0.5/-0} mm (horizontal × vertical)

- 2 To conform to UL Type 4X standards, the panel thickness must be between 1.6 and 4.5 mm. Always use the NA5-□□W□□□□ with a High-pressure Waterproof Attachment (PWA) in applications requiring UL Type 4X level protection. This is mandatory because there is a risk of water entry, which may cause severe equipment damage.

Make sure that the internal dimensions at the back of the PWA allow mounting.

Model	Dimensions without PWA	Dimensions with PWA
NA5-15W□□□□	420 × 291 mm	430 × 306 mm
NA5-12W□□□□	340 × 244 mm	348 × 259 mm
NA5-9W□□□□	290 × 190 mm	298 × 203 mm
NA5-7W□□□□	236 × 165 mm	236 × 178 mm

Model	PWA model number
NA5-15W□□□□	NA-15WATW01
NA5-12W□□□□	NA-12WATW01
NA5-9W□□□□	NA-9WATW01
NA5-7W□□□□	NA-7WATW01

Slide the PWA over the NA Unit from the back until the flat side of the PWA is flat against the inside of the panel, as shown in the following figure.

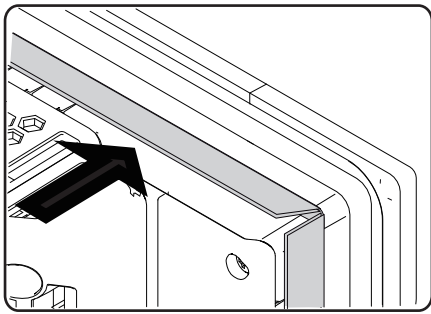

3 Attach the panel mounting brackets from the back of the panel as shown in the following figure. The number of mounting brackets depends on the size of the NA Unit, as shown in the following table. Refer to *Bracket Mounting Locations for Different Units* on page 3-8.

Model	Number of Panel Mounting Brackets
NA5-15W□□□□	8 locations
NA5-12W□□□□	6 locations
NA5-9W□□□□	4 locations
NA5-7W□□□□	4 locations

Catch the brackets in the mounting holes in the NA Unit, pull forward lightly, and then use a Philips screwdriver to tighten the screws and secure the NA Unit to the panel, which will be held between the mounting brackets and the NA Unit.

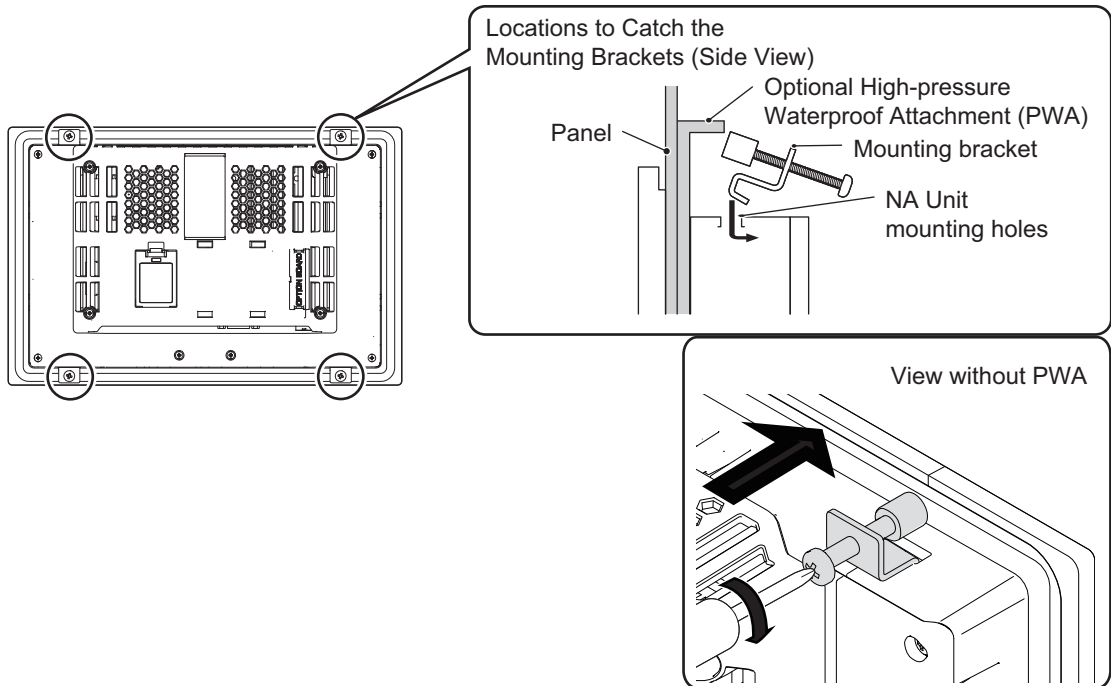



Precautions for Safe Use

- Do not let metal particles enter the NA Unit when preparing the panel.
 - To conform to UL Type 4X standards, the thickness must be 1.6 to 4.5 mm.
To conform to UL Type 4X standards, always use the NA5-□□W□□□□ with a High-pressure Waterproof Attachment (PWA). If you do not use a PWA, there is a risk of water entry, which may cause severe equipment damage.
 - Tighten the Mounting Brackets evenly to a torque of between 0.5 and 0.6 N·m to maintain water and dust resistance. If the tightening torque exceeds the specified value, or the tightening is not even, deformation of the front panel may occur. What is more, make sure the panel is not dirty or warped and that it is strong enough to hold the NA Unit.
 - As the rubber packing will deteriorate, shrink, or harden depending on the operating environment, periodical inspection is necessary.
-



Precautions for Correct Use

- Completely shield the gap at openings in the control panel or operation panel with a gasket.
 - Refer to *Grounding* on page 3-12 and wire the functional ground terminal () of the NA-series PT as required.
-



Additional Information

The NA Units comply with shipbuilding standards. Refer to *Conformance to Shipbuilding Standards* on page 21 for information on applicable shipbuilding standards.



Additional Information

Bracket Mounting Locations for Different Units

When you mount an NA Unit, secure it with the mounting brackets as shown in the following figures.

- NA5-15W□□□□

Secure the NA Unit with mounting brackets in the eight locations shown below.

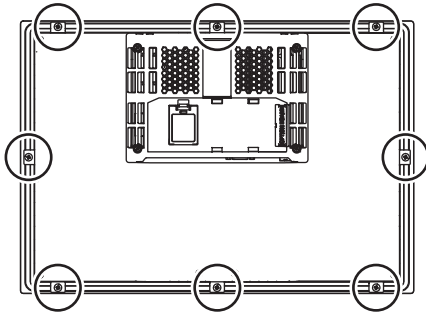

- NA5-12W□□□□

Secure the NA Unit with mounting brackets in the six locations shown below.

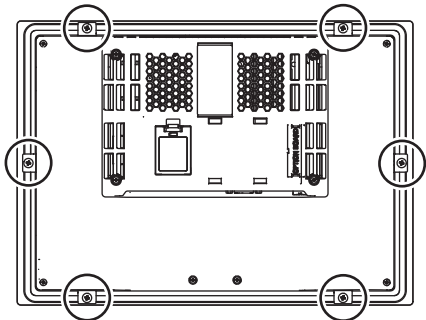

- NA5-9W□□□□

Secure the NA Unit with mounting brackets in the four locations shown below.

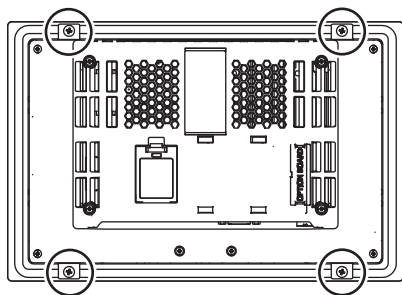

- NA5-7W□□□□

Secure the NA Unit with mounting brackets in the four locations shown below.

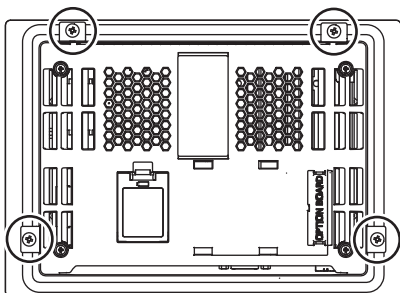

3-4 Wiring Methods

This section describes how to wire an NA Unit.

WARNING

Make sure that the voltage and current that are input to the NA Unit are within the specified ranges. Inputting voltages or currents that are outside of the specified ranges may cause accidents or fire. 

WARNING

Be sure that all terminal block screws and cable connector screws are tightened to the torque specified in the relevant manuals. The loose screws may result in fire or malfunction. Do not touch any equipment when power is being supplied or immediately after the power supply is turned OFF. You may be burnt. 

3-4-1 Power Supply Wiring

Connect a 24-VDC power supply to the power supply input terminals.



Precautions for Safe Use

- Use a DC power with a slight voltage fluctuation and that will provide a stable output even if the input is momentarily interrupted for 10 ms. Also use the one with reinforced insulation or double insulation.
Rated Power Supply Voltage: 24VDC (Allowable range 19.2 to 28.8VDC)
- Do not perform a dielectric strength test.



Precautions for Correct Use

- Do not allow wire clippings, shavings, or other foreign material to enter the NA Unit. Otherwise, burning, failure, or malfunction may occur. Cover the NA Unit or take other suitable countermeasures, especially during wiring work.
- To use a power supply that does not contain a protection circuit, supply power to the NA Unit through a fuse or other protective element.

Power Supply Specifications

The specifications of a connectible power supply are given in the following table.

Item	Value
Rated supply voltage	24 VDC
Allowable voltage fluctuation range	19.2 to 28.8 VDC (24 VDC \pm 20%)
Power supply capacity	NA5-15W□□□□: 47 W min.
	NA5-12W□□□□: 45 W min.
	NA5-9W□□□□: 40 W min.
	NA5-7W□□□□: 35 W min.

Wiring Materials

Use the enclosed power supply connector to connect the power supply to the NA Unit.

- We recommend that you use a power supply cable with the following stranded wires. Wire the power supply giving sufficient consideration to the voltage drop and heat generation for the cable length in the installation environment.

● Applicable Wires (Stranded Wires)

Size	Conductor cross-section
AWG12 to AWG22	0.35 to 3.31 mm ²

● Power Supply Connector

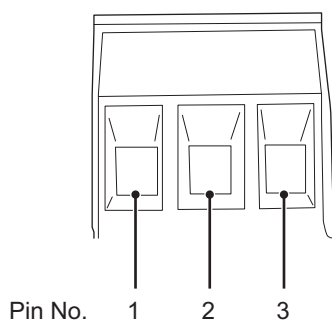

Pin No.	Signal name	Name
1	+24 V	+24-V input
2	0 V	0 V
3	FG	Functional ground

Wiring

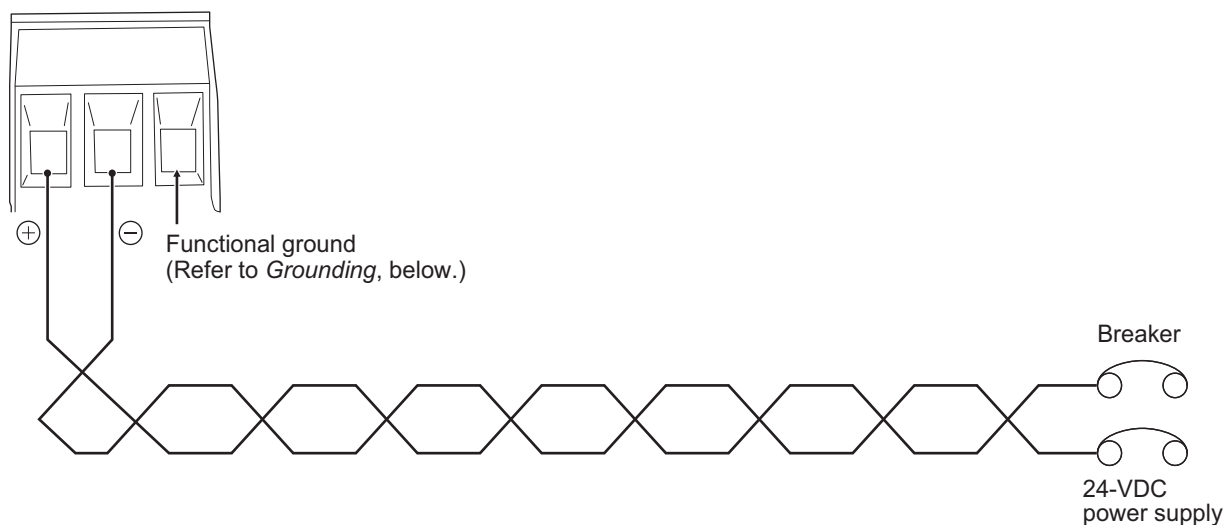

Wiring Procedure

Use the following procedure to connect the power supply.

- 1 Remove the sheath from the power supply wires.



- 2 Remove the power supply connector from the NA Unit and loosen the terminal block screws.

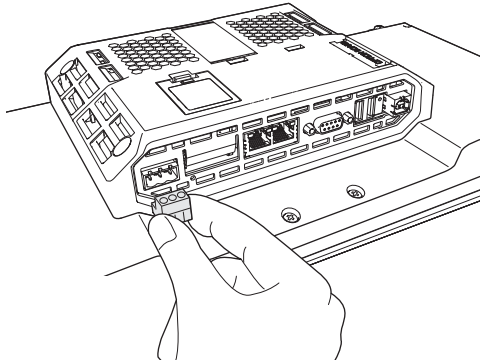

- 3 Insert the wires all the way to the back of the connector and then turn the screws clockwise to secure the wires.

Use a small flat-blade screwdriver and tighten the screws to between 0.5 and 0.6 N·m.

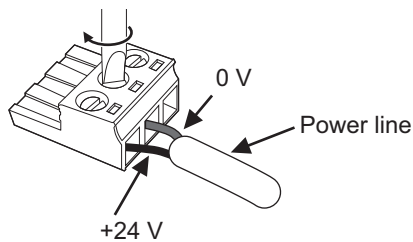

- 4 Attach the power supply connector to the NA Unit.

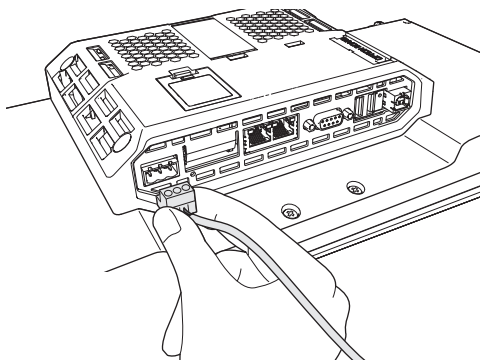

**Precautions for Correct Use**

Observe the following precautions to prevent broken wires.

- When you remove the sheath, be careful not to damage the conductor.
- Connect the conductor without twisting the wires.
- Do not weld the conductors. If you do so, vibration may cause the wires to break.
- Do not apply stress to the cable after you have connected the wires.
- Before you insert a wire into a terminal hole, turn the screw that tightens the terminal counterclockwise until the terminal is no longer visible. Then, insert the wire so that it is held on the terminal and screw side of the case and turn the screw clockwise to tighten the terminal.

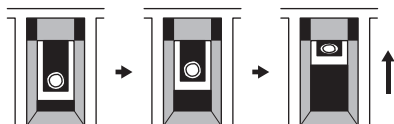

- Faulty contact will result if you turn the screw counterclockwise to secure the wire. If necessary, remove the wire, make sure it is inserted in the terminal hole, and then connect it again.

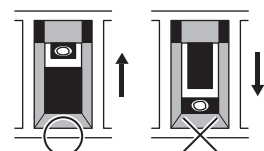

Clockwise Counterclockwise

Grounding

The NA Unit has a functional ground terminal () . Wire the functional ground terminal according to the following conditions.

- If there is a difference in electrical potential between the NA Unit and the connected devices, ground them as shown in the following figure.

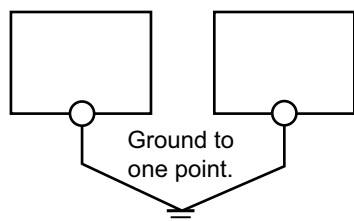
**Precautions for Safe Use**

To prevent malfunctions caused by noise, ground the NA Unit correctly.

**Precautions for Correct Use**

If the connected devices are separated too far from the NA Unit to ground them to the same point and the NA Unit is installed in the same panel as devices that generate noise (such as motors and inverters), do not ground the NA Unit.

3-4-2 Wiring the Ethernet Port

Refer to the *NA-series Programmable Terminal Device Connection Manual* (Cat. No. V120) for information on wiring the Ethernet ports.

3-4-3 Wiring the Serial Port

The serial port is for future expansion. Do not wire this port.

3-5 Control Panel Installation

To ensure system reliability and safety, the system must be designed and configured according to the installation environment (temperature, humidity, vibration, shock, corrosive gases, overcurrent, noise, etc.).

3-5-1 Temperature

Panels have been reduced in size due to space-saving and miniaturization in devices and systems, and the temperature inside the panel may be at least 10 to 15°C higher than outside the panel. Implement the following measures against overheating at the installation site and in the panel, and allow a sufficient margin for the temperature.

High Temperatures

Use the following cooling methods as required, taking into account the ambient temperature and the amount of heating inside the panel.

● Natural Cooling

Natural cooling relies on natural ventilation through slits in the panel, rather than using cooling devices such as fans or coolers. When using this method, observe the following points.

- Do not install the NA Unit at the top of the panel, where hot air tends to stagnate.
- To provide ventilation space above and below the NA Unit, leave sufficient distance from other devices, wiring ducts, etc.
- Do not mount the NA Unit in the wrong direction (e.g., vertically or upside down). Doing so may cause abnormal heating in the NA Unit.
- Do not install the NA Unit above any heat-generating equipment, such as heaters, transformers, and devices with high resistance.
- Do not install the NA Unit in a location exposed to direct sunlight.

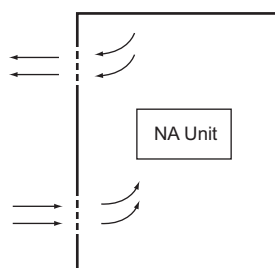

● Forced Ventilation (with Fan at Top of Panel)

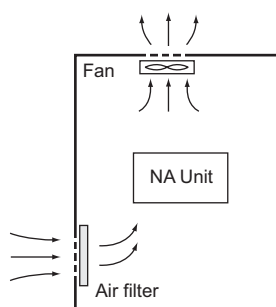

Forced Ventilation Method

- **Forced Air Circulation (with Fan in Closed Panel)**

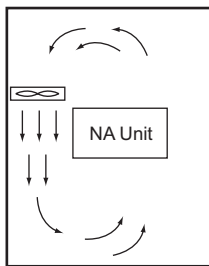

Forced Circulation

- **Room Cooling (Cooling the Entire Room Where the Control Panel Is Located)**

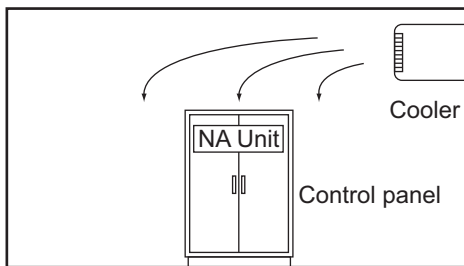

Room Cooling

Low Temperatures

The NA Unit may not start normally if the temperature is below 0°C when the power is turned ON.

Maintain an air temperature of at least approximately 5°C inside the panel, by implementing measures such as installing a low-capacity space heater in the panel. Alternatively, leave the NA Unit power ON to keep the NA Unit warm.

3-5-2 Humidity

Rapid temperature changes can cause condensation to occur, resulting in malfunctioning due to short-circuiting. When there is a possibility of this occurring, take measures against condensation, such as leaving the NA Unit power ON at night or installing a heater in the control panel to keep it warmer.

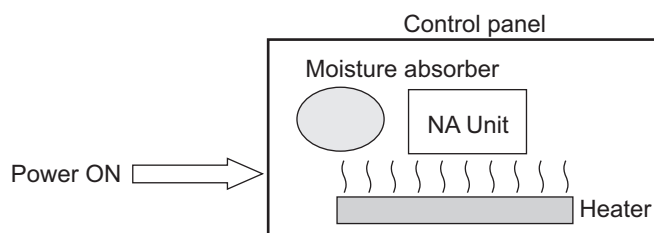

Examples of Measures against Condensation

3-5-3 Vibration and Shock

The NA Unit is tested for conformity with the sine wave vibration test method (IEC 60068-2-6) and the shock test method (IEC 60068-2-27) of the Environmental Testing for Electrotechnical Products. It is designed so that malfunctioning will not occur within the specifications for vibration and shock. If, however, the NA Unit is to be used in a location in which it will be directly subjected to regular vibration or shock, then implement the following countermeasures:

- Separate the control panel from the source of the vibration or shock.
Or, secure the NA Unit and the panel with rubber padding.
- Make the building or the floor vibration resistant.
- To prevent shock when other devices in the panel such as electromagnetic contactors operate, secure either the source of the shock or the NA Unit with rubber padding.

3-5-4 Atmosphere

Using the NA Unit in any of the following locations can cause defective contact with connectors and corrosion of components. Implement countermeasures such as purging the air as required.

- In locations exposed to dust, dirt, salt, metal powder, soot, or organic solvents, use a panel with an airtight structure. Be careful of temperature increases inside the panel.
- In locations exposed to corrosive gas, purge the air inside the panel to clear the gas and then pressurize the inside of the panel to prevent gas from entering from outside.
- In locations where flammable gas is present, either use an explosion-protected construction or do not use the NA Unit.

3-5-5 Electrical Environment

When installing or wiring devices, make sure that there will be no danger to people and that noise will not interfere with electrical signals.

Installation Locations for NA Unit

Install the NA Unit as far away as possible from high-voltage (600 V or higher) and power devices to ensure safe operation and maintenance.

Example of Recommended Equipment Arrangement

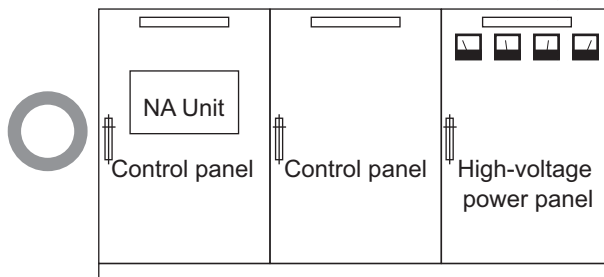

Example of Poor Equipment Arrangement

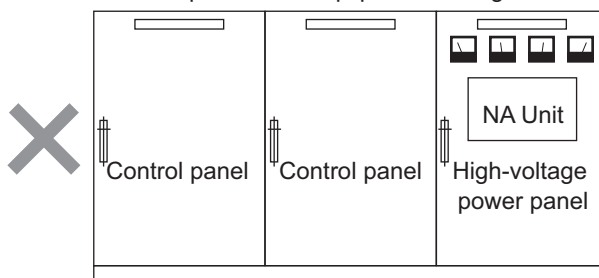

Examples of Equipment Arrangement in Panel with High-voltage Devices

External Wiring

Wiring, and noise countermeasures in particular, must be based mostly on experience, and it is necessary to closely manage wiring based on information in the manuals.

● Wiring Routes

Each of the following combinations includes different signal types, properties, or levels. They will cause the signal-to-noise ratio to drop due to factors such as electrical induction. As a general rule when wiring, either use separate cables or separate wiring routes for these items. Future maintenance operations and changes to the system will also be made easier by carefully organizing the wiring from the start.

- Power lines and signal lines
- Input signals and output signals
- Analog signals and digital signals
- High-level signals and low-level signals
- Communications lines and power lines
- DC signals and AC signals
- High-frequency devices (such as Inverters) and signal lines (communications)

● **Wiring Methods**

Observe the following points when wiring power supply and signal cables.

- When routing signal cables with different characteristics through the same duct, always keep them separated.
- As much as possible, avoid routing multiple power supply lines through the same duct. If it cannot be avoided, then construct a partition between them in the duct and ground the partition.

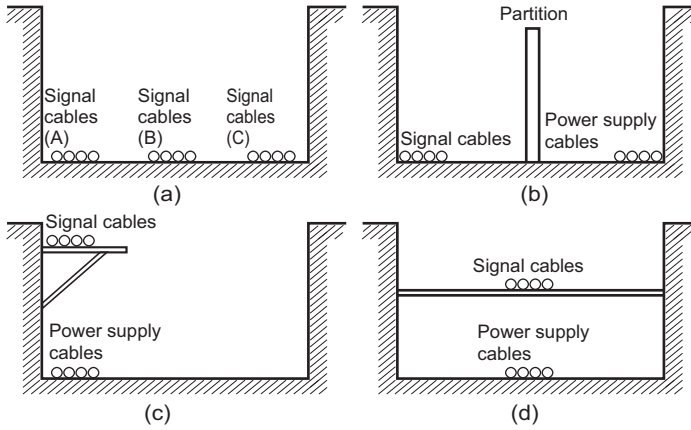

Partitioning Methods for Signal and Power Supply Cables

- To avoid overheating the conduits when using conduits for wiring, do not place wires for a single circuit in separate conduits.

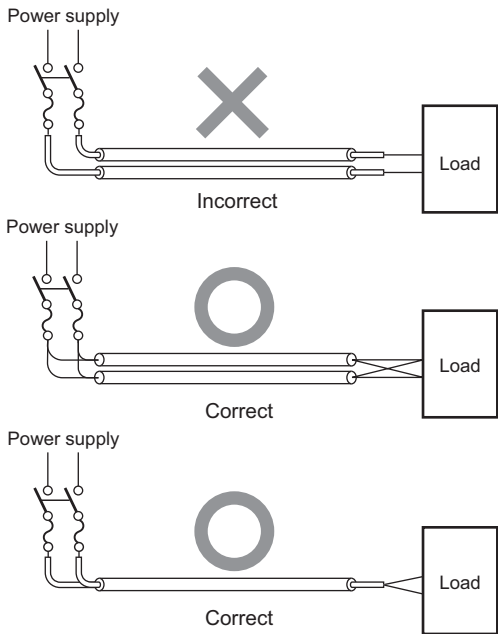

Parallel Wiring (Single Phase)

- Power cables and signal cables adversely affect each other. Do not wire them in parallel.
- Noise induction may occur if the NA Unit is installed in a panel that includes high-voltage devices. Wire and install them as far apart as possible.

- Either install the NA Unit a minimum of 200 mm away from high-voltage lines or power lines, or place the high-voltage lines or power lines in metal tubing and completely ground the metal tubing to 100 Ω or less.

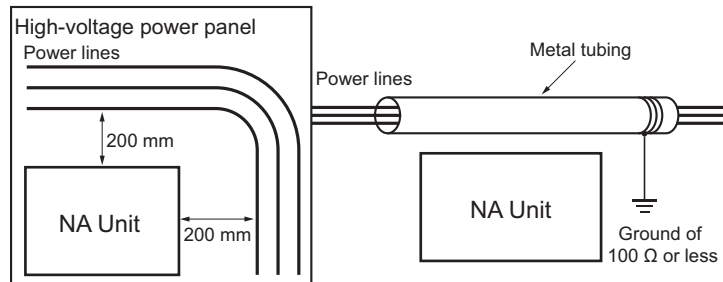

Example: Separating NA Unit from Power Lines

3-5-6 Grounding

Grounding has the following two purposes.

- **Protective Grounding**
Protective grounding is done to ensure safety. It is intended to prevent electrical shock by holding the electrical potential at the grounding potential that is generated by factors such as leakage, induction, or failure.
- **Functional Grounding**
Functional grounding is done to protect device and system functions, including prevention of noise from external sources, or prevention of noise from devices or equipment that could have harmful effects on other devices or equipment.

Grounding requirements sometimes depend on the situation, and they may be found based on experimentation. It is important to sufficiently check the particular circumstances before grounding.

Grounding Methods and Precautions

● Principles of One-point Grounding

For devices to operate properly, the reference potential between the devices must be stabilized. Use one-point grounding so that noise current does not flow to ground lines between the devices.

- Use one-point grounding as shown in figure (a). Connect to the ground pole of the other devices.
- Never connect to the same ground as a device that draws a large amount of power, such as a motor or inverter. Ground the devices separately to avoid mutually adverse influences.
- To prevent electrical shock, do not connect to ground poles (or steel frames) to which multiple devices are connected.
- Use a ground pole as close to the NA Unit as possible and keep the ground line as short as possible.

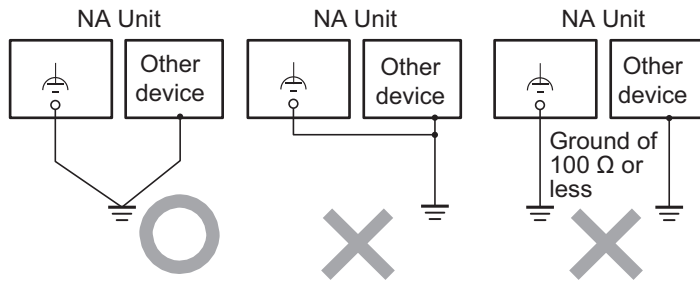

(a) One-point grounding: Acceptable (b) Common ground: Incorrect (c) Independent grounds: Incorrect

● **Precautions when Grounding**

- If the same ground is used for both the signal lines and the enclosure, isolate the channel base (a grounded metal plate inside a control panel) with an insulating material.

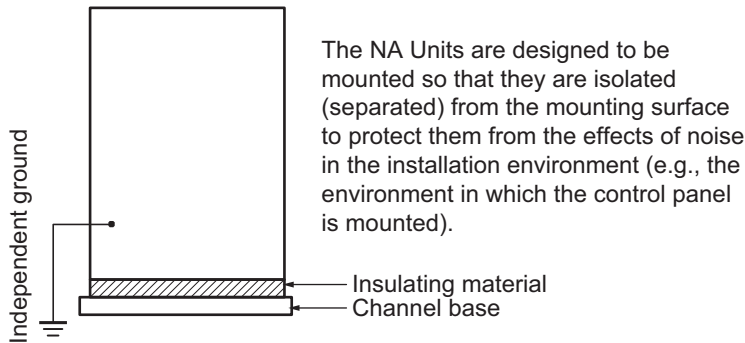

- To prevent influence from leakage current from other electrical devices, electrically isolate the panel in which the NA Unit is housed from other devices.
- If high-frequency equipment is present, then ground not only the high-frequency equipment but also the panel itself in which the NA Unit is housed.

● **NA Unit Functional Ground Terminal**

The NA Unit has the following ground terminal.

Functional ground terminal: Connected to a neutral point in the noise filter to provide a ground when power supply noise causes malfunctioning.

When the functional ground terminal is correctly grounded, it is generally effective in suppressing power supply common noise. Occasionally, however, grounding this terminal will result in picking up more noise, so be careful when using it.

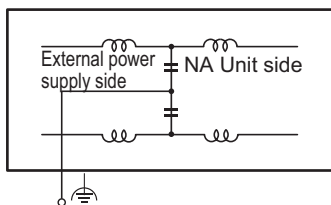

Connections When Using an External Noise Filter

4

System Program

This section describes the system program that is used by NA-series Programmable Terminals.

4

4-1	System Program and NA Unit Startup Status	4-2
4-2	System Recovery	4-3
4-3	System Menu Overview	4-6
4-3-1	System Menu Configuration	4-6
4-3-2	Using the System Menu	4-9
4-4	System Menu Details	4-11
4-4-1	Display Settings (Project System Menu)	4-11
4-4-2	Language Settings (Project System Menu)	4-12
4-4-3	Communications Settings (Project System Menu)	4-12
4-4-4	User Accounts (Project System Menu)	4-13
4-4-5	NJ/NX Troubleshooter (Project System Menu)	4-14
4-4-6	Alarm Viewer (Project System Menu)	4-25
4-4-7	Project System Menu Settings (Project System Menu)	4-27
4-4-8	Print Settings (Project System Menu)	4-27
4-4-9	Buzzer Settings (Project System Menu)	4-28
4-4-10	Date & Time Settings (Device System Menu)	4-29
4-4-11	Language Settings (Device System Menu)	4-29
4-4-12	Interface Settings (Device System Menu)	4-30
4-4-13	Brightness Settings (Device System Menu)	4-35
4-4-14	Transfer Operations (Device System Menu)	4-36
4-4-15	Hardware Diagnostics (Device System Menu)	4-41
4-4-16	Production Information (Device System Menu)	4-44

4-1 System Program and NA Unit Startup Status

The system program is required to start the NA Unit and execute the project in the NA Unit.

- The system program automatically starts when you turn ON the power supply to the NA Unit or when you press the reset switch while power is supplied.
When the system program starts, one of the following states is entered.
 - a) If there is an executable project in the NA Unit, the project is automatically executed.
Refer to *4-3-2 Using the System Menu* on page 4-9 for the procedure to display the System Menu.
 - b) If there is not an executable project in the NA Unit, the System Menu is automatically displayed.
- If there is an error in the system program, the NA Unit will not operate normally.
If you think there is a problem with the system program, system recovery may be necessary.
Refer to *5-2-1 Confirming NA Unit Operation* on page 5-4 and *4-2 System Recovery* on page 4-3 for the method to see whether there is an error in the system program and the system recovery procedure.



Precautions for Correct Use

When you perform system recovery or update the system program, the NA Unit will be returned to the default status and the project will be deleted.

- You may need to update the system program from time to time, e.g., when support for a new connected device is added to the NA Units. In this case, the system program is automatically downloaded from the Sysmac Studio.

4-2 System Recovery

You can implement system recovery if the NA Unit will not start normally or if you want to initialize the contents of the NA Unit to the default state.

When you implement system recovery, all of the user data is deleted from the NA Unit and the system program is overwritten with the newest version.

System Recovery Procedure

Use the following procedure for system recovery.

- 1** Prepare a formatted SD Memory Card or USB Memory Device.
- 2** Execute the following file in the Sysmac Studio installation media.
 Sysmac_Studio_installation_media\Utility\NA_RecoverUpdate\NA_RecoverUpdate_□_□_□.exe
- 3** Specify the root folder on the media you prepared in step 1 as the extraction location.
- 4** Turn OFF the power supply to the NA Unit.
- 5** Open the battery cover on the back of the NA Unit and set the DIP switch to the settings shown below. When you finish setting the DIP switch, close the battery cover.

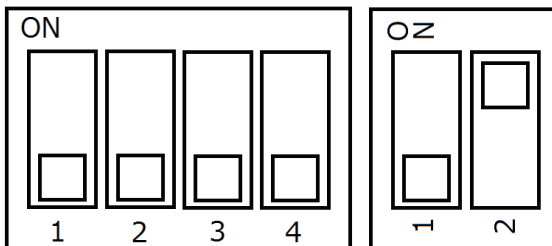

- 6** Insert the media that you prepared in step 2 into the NA Unit and turn ON the power supply to the NA Unit.
- 7** Select the model of NA Unit to use.

Warning!!

The contents of EEPROM seem to have been corrupted. Choose your model from the list below to sort the problem out.

NA5-9W001S
▼

Confirm

8 Tap the language to use for system recovery.

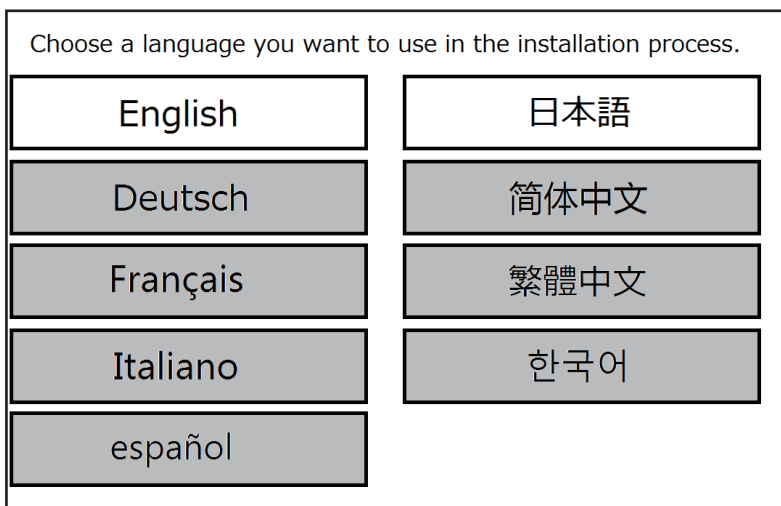

9 Select the package that you want to install, and then tap the **Install** Button.

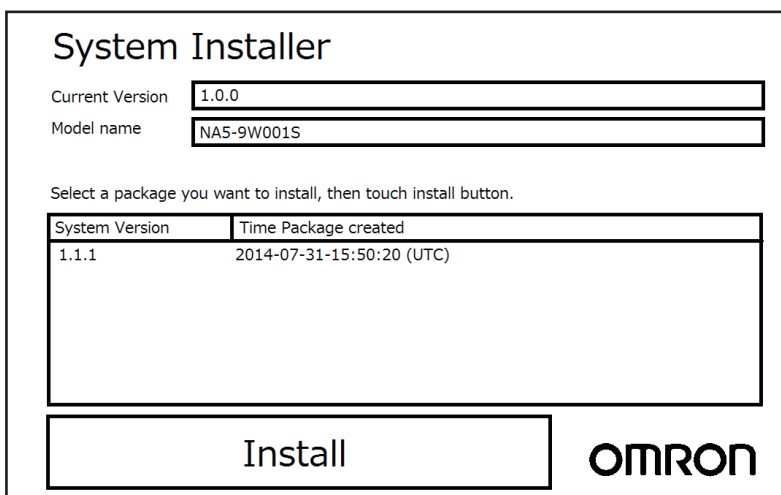

10 Tap the **Yes** Button.

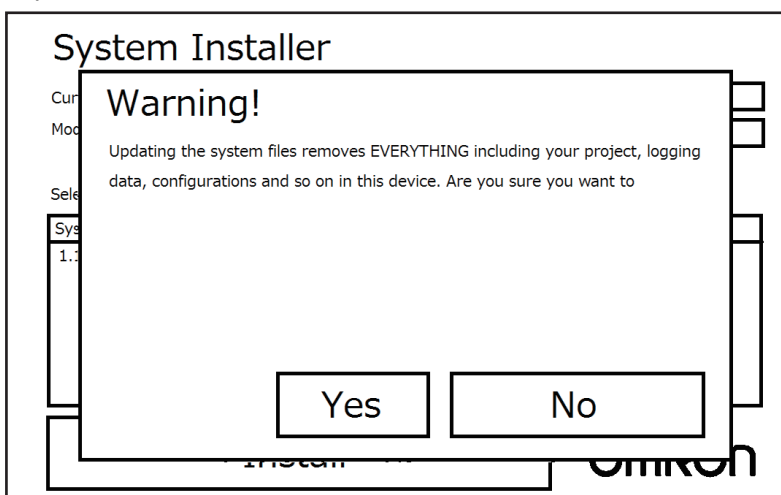

- 11** When the following message is displayed, remove the media from the NA Unit and turn OFF the power supply to the NA Unit.

System Installer

Installation completed.

```

Initializing the internal storage device...done.
Preparing the disk for storing project data...done.
Installing the new system...done.
Installation completed 30 seconds.
  
```

Now remove the USB storage device or the SD card, turn off the device, revert the DIP switches to the original state and turn on the device.

- 12** Open the battery cover on the back of the NA Unit and set the DIP switch to the settings shown below. When you finish setting the DIP switch, close the battery cover.

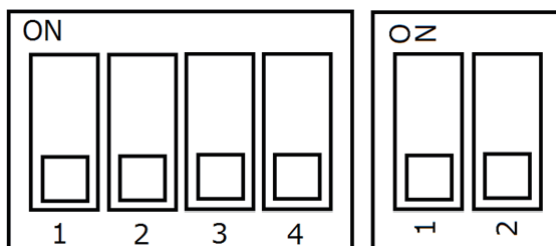

This concludes system recovery.

4-3 System Menu Overview

You can use the System Menu to perform operations according to on-screen displays to perform various settings for the NA Unit.

Refer to *4-3-1 System Menu Configuration* on page 4-6 for the configuration of the System Menu.

Refer to *4-3-2 Using the System Menu* on page 4-9 for the procedures to use the System Menu.

4-3-1 System Menu Configuration

The initial display for the System Menu depends on whether there is a project in the NA Unit.

If there is a project, the Project System Menu is displayed initially. If there is no project, the Device System Menu is displayed initially and you cannot access the Project System Menu.

The following items and functions are displayed on the System Menu.

- Project System Menu (1/2)

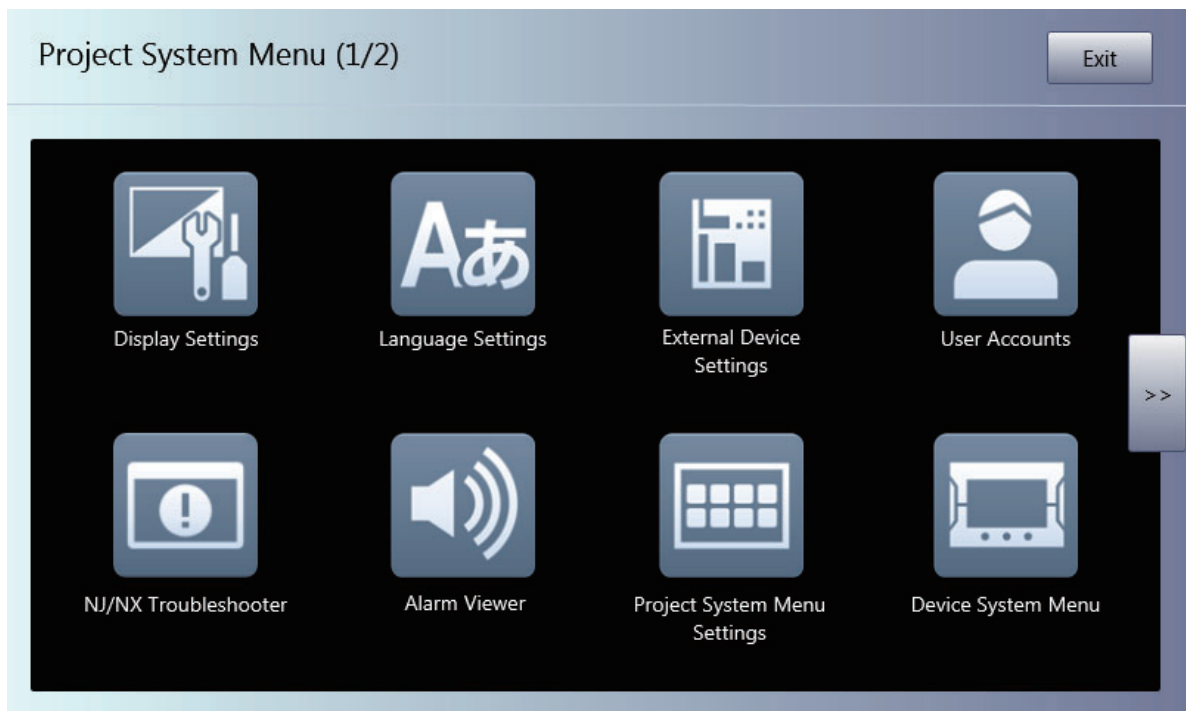

Item	Description	Reference
Display Settings	Sets the screen saver and display brightness.	P. 4-11
Language Settings	Sets the user language and the system language.	P. 4-12
External Device Settings	Sets the communications settings for connected devices.	P. 4-12
User Accounts	Sets the user account settings.	P. 4-13
NJ/NX Troubleshooter	Displays the NJ/NX Troubleshooter.	P. 4-14
Alarm Viewer	Displays user alarms.	P. 4-25
Project System Menu Settings	Sets the starting method for the System Menu.	P. 4-27
Device System Menu	Calibrates the touch panel.	P. 4-41

- Project System Menu (2/2)

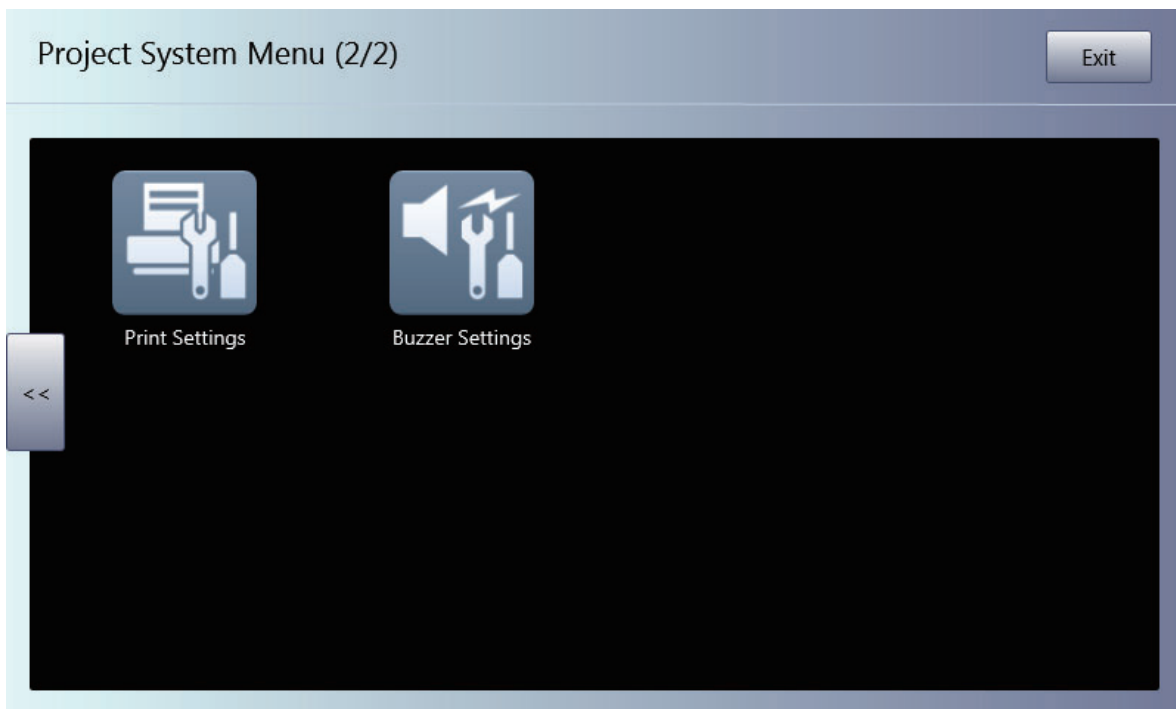

Item	Description	Reference
Print Settings	Sets up printing/capturing of the NA screens.	P. 4-27
Buzzer Settings	Sets buzzer sounds.	P. 4-28

- Device System Menu

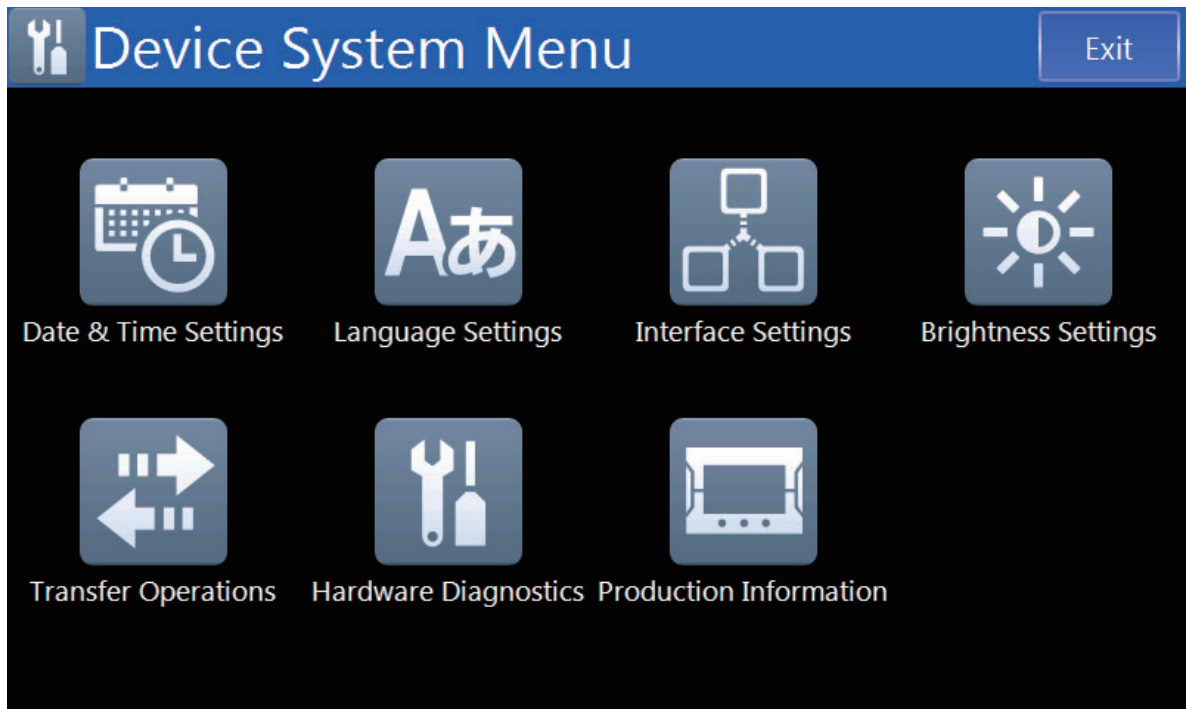

Item	Description	Reference
Date & Time Settings	Sets the date and time, as well as settings for synchronization with the time server.	P. 4-29
Language Settings	Makes settings for the system language.	P. 4-29
Interface Settings	Makes settings for the NA Unit interface.	P. 4-30
Brightness Settings	Sets the screen brightness.	P. 4-35
Transfer Operations	Transfers the project and data.	P. 4-36
Hardware Diagnostics	Calibrates the touch panel.	P. 4-41
Production Information	Gives the lot number of the NA Unit and other information.	P. 4-44

4-3-2 Using the System Menu

This section describes how to use the System Menu, including the display methods and how to select menu items.



Additional Information

The system settings that are made in the Sysmac Studio project data take priority over the settings that are made from the System Menu.

System Menu Display Methods

You can display the System Menu with any of the following methods. Refer to the *NA-series Programmable Terminal Software User's Manual* (Cat. No. V118) for information on actions and subroutines.

- Double-tapping one of the four corners of the touch panel
 - Executing the ShowSystemMenu action
 - Executing the ShowSystemMenu function in a subroutine
- **Double-tapping one of the four corners of the touch panel**

Double-tapping one of the four corners of the touch panel on the NA Unit.

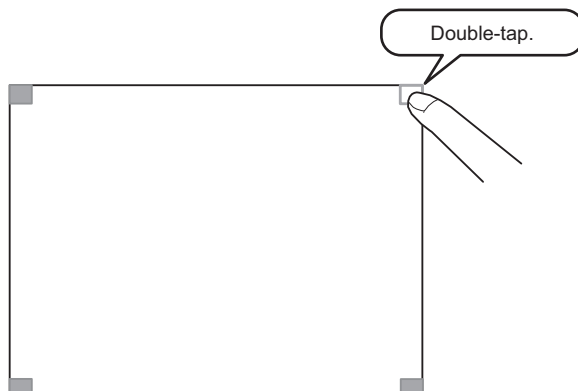

When you tap one of the four corners of the touch panel, tap one where no object is displayed. If you tap a corner where an object is displayed, the function of the object is executed. You can also choose the active locations from the four corners.

- **Executing the ShowSystemMenu Action**

When you create the application, you can create a button on a page and assign the ShowSystemMenu action to that button. Then when you tap the button, the System Menu is displayed.

- **Executing the ShowSystemMenu Function in a Subroutine**

When you create the application, you can create a button on a page and assign that button to a subroutine that executes the ShowSystemMenu function. Then when you tap the button, the System Menu is displayed.

Selecting Menu Items

Tap a menu item or icon on the System Menu to display the corresponding functionality.

Example: Tap the **Hardware Diagnostics** Icon on the Device System Menu to display the Hardware Diagnostics Screen.

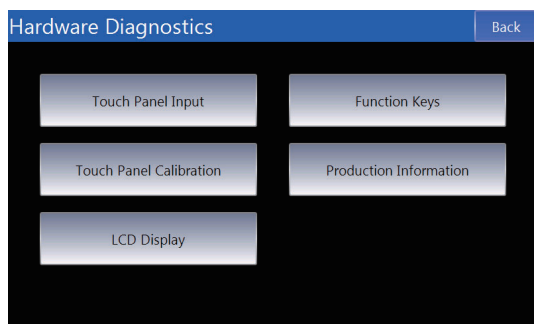
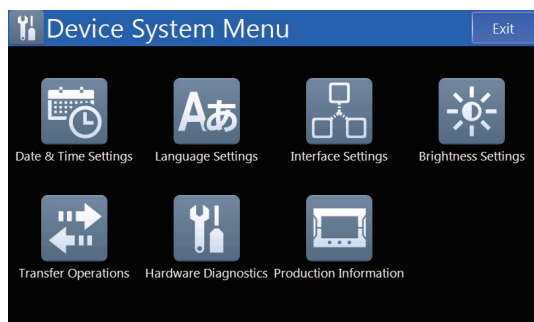

Leaving the System Menu to Enter Operating Status

Tap the **Exit** Button on the Project System Menu to return to Run Status. Any changes to settings are applied when you return to Run Status. To enable some settings, you may have to reset the NA Unit.

Common System Menu Operations

This section describes the functions that are common to the entire System Menu.



This button exits the System Menu and places the NA Unit in Run Status or displays the Project System Menu.



This button changes to a page at the next higher level.



This button applies local changes to settings.

4-4 System Menu Details

This section describes the functions that are provided by the System Menu.

4-4-1 Display Settings (Project System Menu)

You can use the display settings to set the following items.



No.	Item	Description
(a)	Screen Saver Enabled	Select this check box to use the screen saver.
(b)	Type	Sets the type of screen saver.
(c)	Timeout	Sets the time until the screen saver is started in minutes.
(d)	Brightness	Sets the screen brightness.

4-4-2 Language Settings (Project System Menu)

You can use the language settings to set the following items.

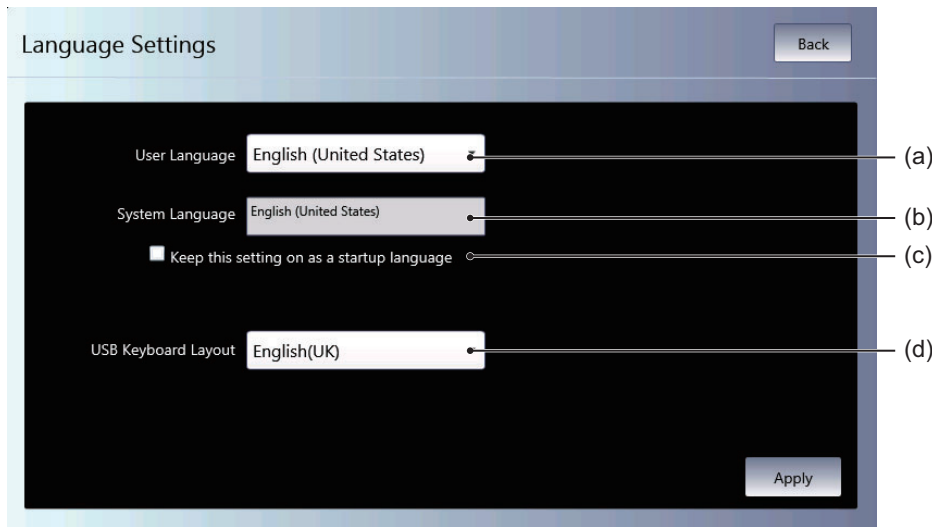

No.	Item	Description
(a)	User Language	Sets the user language.
(b)	System Language	Displays the system language that is associated with the user language.
(c)	Keep this setting on as a startup language	If you select this check box, the language that is set as the system language is used as the startup language.
(d)	USB Keyboard Layout	Sets the layout of a USB keyboard.

4-4-3 Communications Settings (Project System Menu)

You can use the communications settings to set the following items.

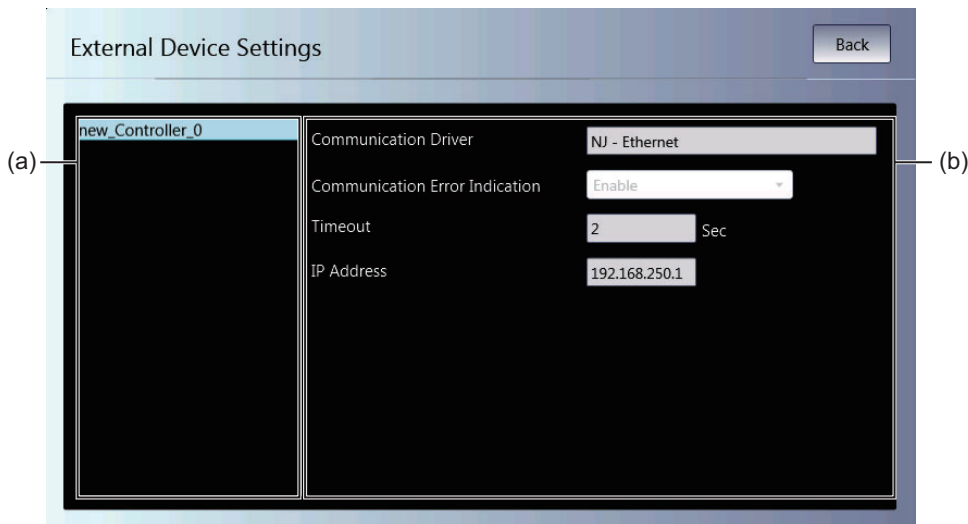

No.	Item	Description
(a)	Connected Device List	Displays a list of the connected devices that are registered in the project.
(b)	Connected Device Communications Settings	Displays the communications settings of the connected device that is selected in the list. Refer to the <i>NA-series Programmable Terminal Device Connection User's Manual</i> (Cat. No. V119) for details.

4-4-4 User Accounts (Project System Menu)

You can use the user account settings to set the following items.



Precautions for Safe Use

- When you change a password, do not reset the NA Unit or turn OFF the power supply before writing the new password is completed. A failure to store the password may cause the project to fail to function.



Additional Information

- If you forget a password, there is no way to check for the password on the NA Unit. Use the Sysmac Studio to check.

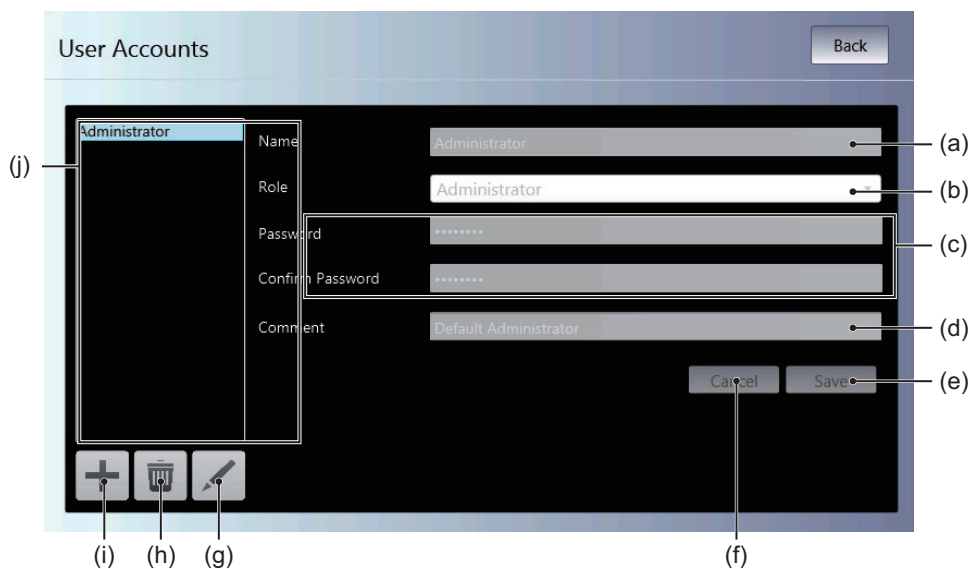

No.	Item	Description
(a)	Name	Sets the name.
(b)	Role	Sets the rights.
(c)	Password	Sets the password.
(d)	Comment	Sets a comment.
(e)	Save	Saves any changes.
(f)	Cancel	Discards any changes.
(g)		Edits the selected user account.
(h)		Deletes the selected user account.
(i)		Adds a user account.
(j)	User account table	A list of the user accounts that are currently registered is displayed.

4-4-5 NJ/NX Troubleshooter (Project System Menu)

The NJ/NX Troubleshooter can be used to access descriptions and countermeasures for errors and events that occur in the Controller and built-in devices. These functions can be used only when you are connected to an NJ/NX-series Controller.

Errors and Events That Can Be Monitored

● User-defined Errors and User-defined Events

Errors and events can be defined by the user with the Sysmac Studio. Detailed information on troubleshooting also can be set. Refer to *Section 1 Overview* in the *NJ/NX-series Troubleshooting Manual* (Cat. No. W503) for details.

● Controller Errors and Controller Events

These errors and events are generated by an NJ/NX-series Controller. These errors and events cannot be edited by the user. Refer to *Section 1 Overview* in the *NJ/NX-series Troubleshooting Manual* (Cat. No. W503) for details.

When Connected to an NX-series CPU Unit

System configuration element		Troubleshooter functions			
		Displaying errors	Clearing errors	Displaying error logs	Clearing error logs
CPU Unit		Applicable			
EtherCAT Slaves (Sysmac devices)		Applicable		Applicable ^{*1}	Applicable ^{*1 *2}
EtherCAT Slave Terminals	EtherCAT Coupler Units	Applicable		Applicable ^{*1}	Applicable ^{*1 *2}
	NX Units	Partially applicable ^{*3}	Applicable ^{*4 *5}	Applicable ^{*1}	Applicable ^{*1 *2}

*1. Supported in runtime version 1.03 or higher.

*2. Event logs for individual units cannot be cleared.

*3. Events are not displayed for some NX Units. If an error occurs in an NX Unit for which events are not displayed, an event for a minor fault in an NX Unit will occur in the EtherCAT Coupler Unit and the unit number of the NX Unit in which the error occurred will be given in the attached information.

*4. Errors that occur on a specific NX Unit cannot be cleared separately.

*5. It might be necessary to reset errors in Safety Control Units with a safety program. Refer to the *NX-series Safety Control Unit User's Manual* (Cat. No. Z930) for details on resetting errors in Safety Control Units.

When Connected to an NJ-series CPU Unit

System configuration element		Troubleshooter functions			
		Displaying errors	Clearing errors	Displaying error logs	Clearing error logs
CPU Rack	CPU Unit	Applicable			
	CJ-series Units	Applicable		Partially applicable ^{*1}	
EtherCAT Slaves (Sysmac devices)		Applicable		Applicable ^{*2}	Applicable ^{*2 *3}
EtherCAT Slave Terminals	EtherCAT Coupler Units	Applicable		Applicable ^{*2}	Applicable ^{*2 *3}
	NX Units	Partially applicable ^{*4}	Applicable ^{*5 *6}	Applicable ^{*2}	Applicable ^{*2 *3}

- *1. You cannot display or delete events in the error history (upper four digits of event code are 0000 hex) in a CJ-series Special Unit mounted on an NJ-series CPU Unit.
- *2. Supported in runtime version 1.03 or higher.
- *3. Event logs for individual units cannot be cleared.
- *4. Events are not displayed for some NX Units. If an error occurs in an NX Unit for which events are not displayed, an event for a minor fault in an NX Unit will occur in the EtherCAT Coupler Unit and the unit number of the NX Unit in which the error occurred will be given in the attached information.
- *5. Errors that occur on a specific NX Unit cannot be cleared separately.
- *6. It might be necessary to reset errors in Safety Control Units with a safety program. Refer to the *NX-series Safety Control Unit User's Manual* (Cat. No. Z930) for details on resetting errors in Safety Control Units.

Starting and Quitting the NJ/NX Troubleshooter

There are three ways to start the NJ/NX Troubleshooter.

- Select **NJ/NX Troubleshooter** from the System Menu.
- Execute *ShowTroubleshooter* in *Action/Function*.
- Set the Troubleshooter operation settings to specify monitoring user-defined or Controller errors. (The NJ/NX Troubleshooter will be displayed automatically when a user-defined error or Controller error occurs.)

● Starting from the System Menu

- 1 Display the System Menu and select **NJ/NX Troubleshooter**.



2 The NJ/NX Troubleshooter will be started.

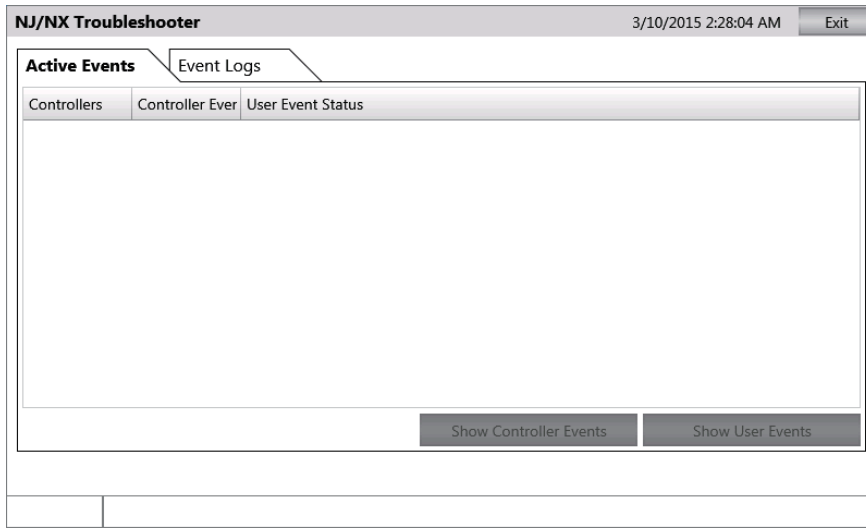

● **Starting from a User Screen**

The required settings must be made from the Sysmac Studio.

The following example shows how to execute the Troubleshooter by using an object event.

In this example, settings are performed to execute the Troubleshooter when a Button object is clicked.

1 Place a Button object on the screen and display *Events and Actions*.

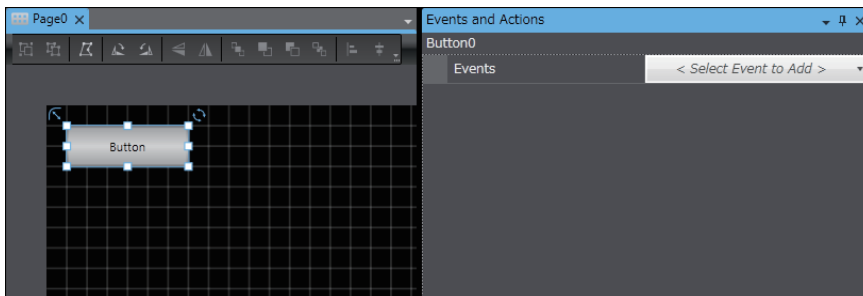

2 Select *Click* as the event.

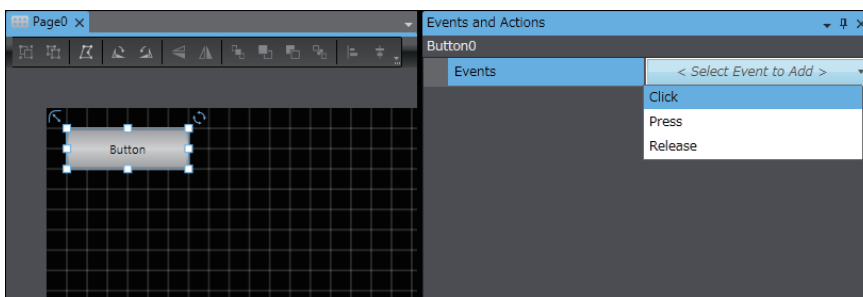

- 3** Select *ShowTroubleshooter* as the action.

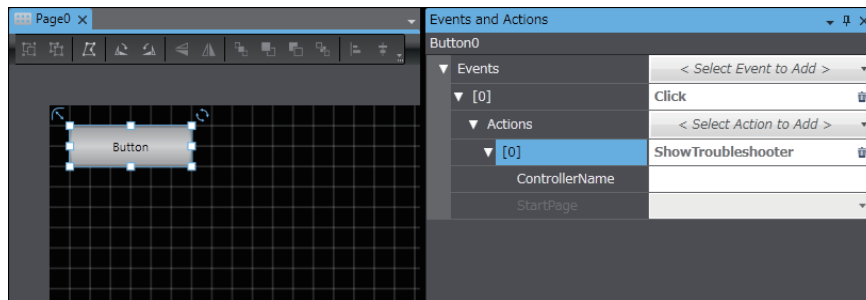

- 4** Specify the name of the Controller to be connected in *ControllerName*.

- 5** Specify the name of the page to be displayed while the Troubleshooter is running in *StartPage*.

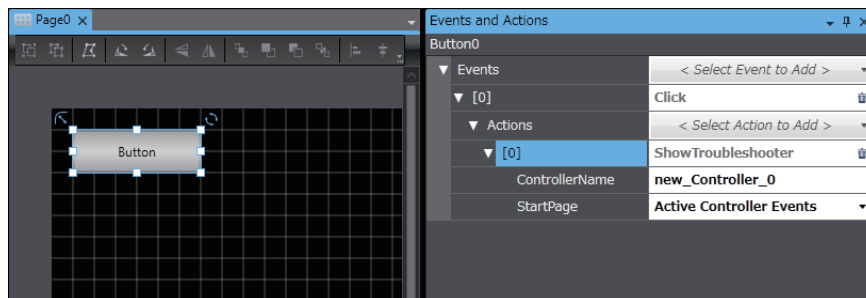

Additional Information

If you use runtime version 1.02 or if you do not specify a name for *ControllerName*, a Controller status list is displayed on the screen when the Troubleshooter is activated.

● Starting the Troubleshooter for User-defined Errors or Controller Errors

The required settings are made from the Sysmac Studio.

- 1** Double-click **Troubleshooter** under **Configurations and Setup** in the Multiview Explorer. The Troubleshooter Settings Tab Page will be displayed in the Edit Pane.
- 2** Select the *Launch on System Event* or *Launch on User Event* Check Box.

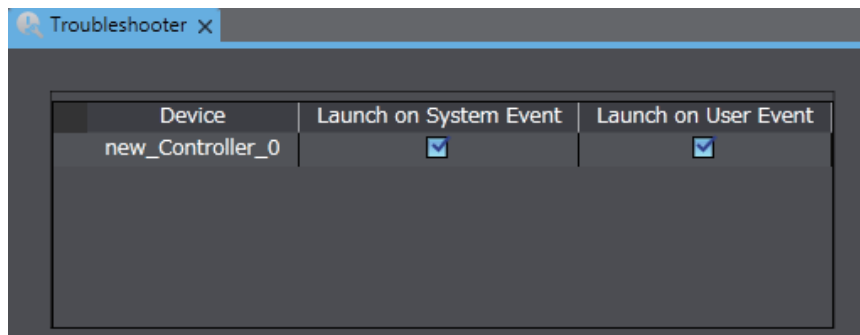

- 3** Generate the type of error that was set in step 2 in the Controller.
- 4** The NJ/NXTroubleshooter will be started.

● **Quitting the NJ/NX Troubleshooter**

- 1 Click the **Exit** Button on the screen that was displayed when the NJ/NX Troubleshooter started.

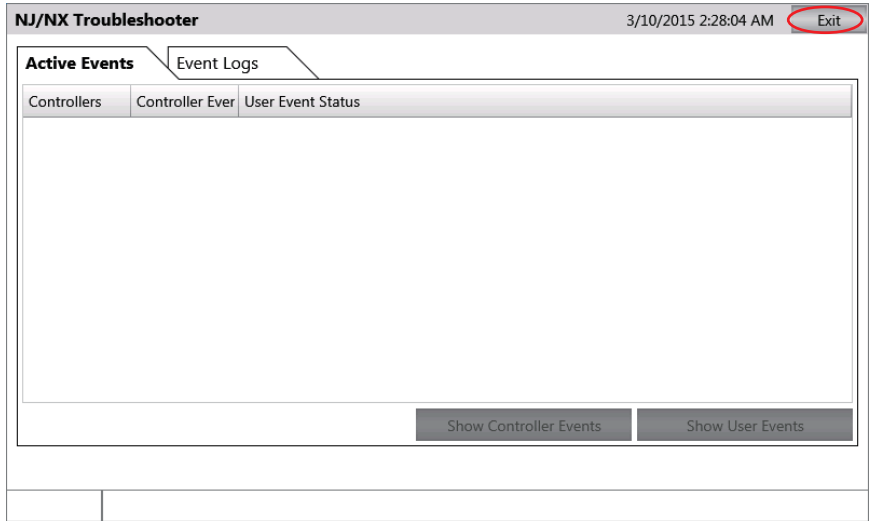

- 2 The display will return to the user screen that was displayed before the NJ/NX Troubleshooter started.

NJ/NX-series Controller Status Screen

The status of the host to which the NA is currently connected is displayed.

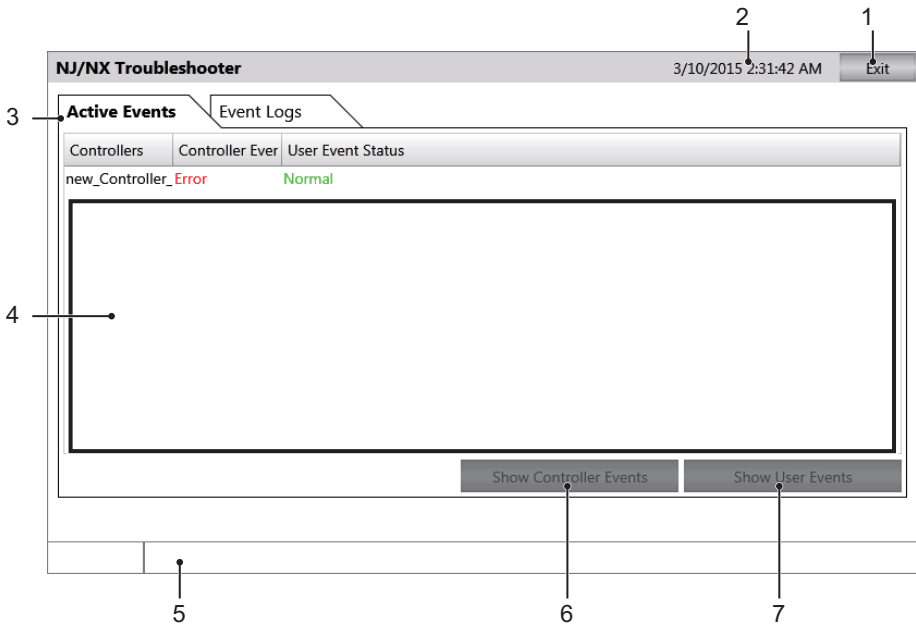

No.	Item	Description
1	Exit Button	Quits the Troubleshooter.
2	Title Bar	Displays the current date of the NA.
3	Tabs	Switch between displaying active events and the event log.
4	Status List	Displays the status of the currently connected host.
5	Status Bar	Displays information on the Controller that is currently selected.
6	Show Controller Events	Displays the Controller Event List Screen of the selected host.
7	Show User Events	Displays the User-defined Event Lists Screen.

Controller Event List Screen

This screen displays a list of the Controller errors for the selected host.

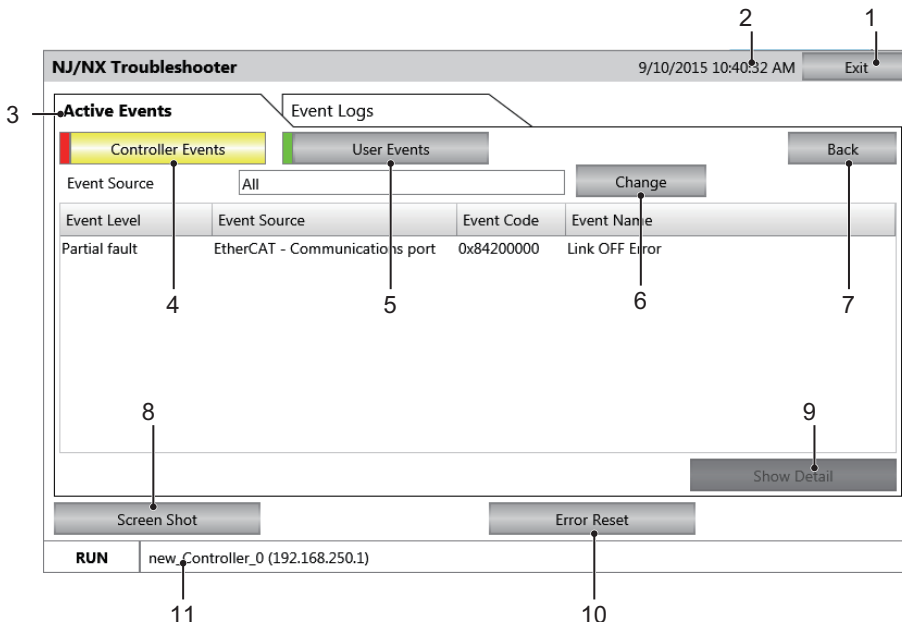

No.	Item	Description
1	Exit Button	Quits the Troubleshooter.
2	Title Bar	Displays the current date of the NA.
3	Tabs	Switch between displaying active events and the event log.
4	Controller Events	Displays current Controller events.
5	User Events	Displays current user-defined events.
6	Change (source of the error) Button	Selects the source of the errors to display and restricts the items to display.
7	Back Button	Returns the display to the NJ/NX-series Controller Status Screen.
8	Screen Shot Button	Captures an image of the displayed screen and stores it in USB memory or an SD Memory Card in PNG format.
9	Show Detail Button	Displays the detailed screen of the current event.
10	Error Reset Button	Clears the events that are displayed on the screen.
11	Status Bar	Displays information on the Controller that is currently selected.



Additional Information

Although user-defined events are also displayed with similar descriptions on the screen, no source is displayed because user events are not displayed according to the Functional Module. When the **Reset** Button is pressed, all of the errors, including anything hidden on the screen, will be cleared.

Controller Event Log Screen

This screen displays a list of the Controller events for the selected host.

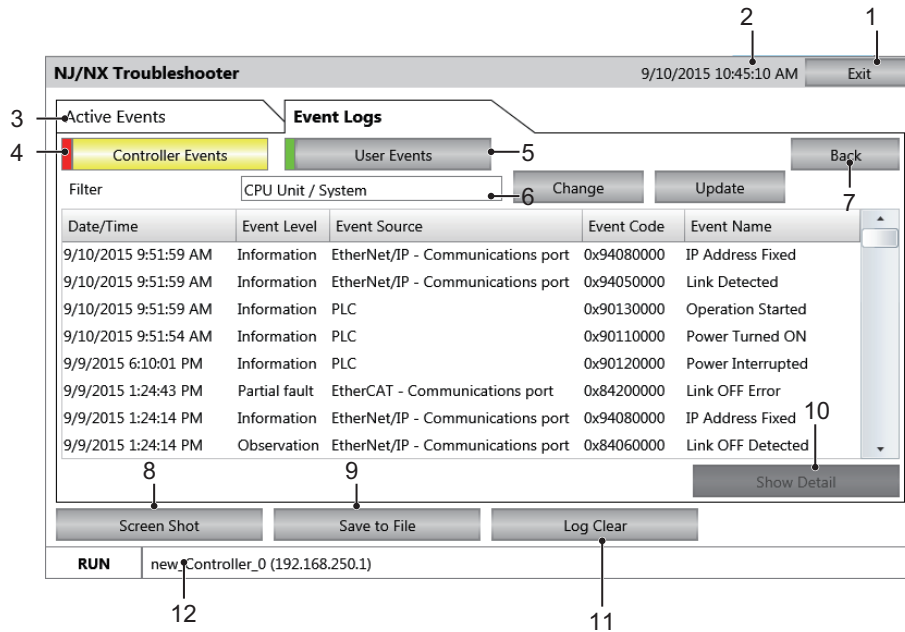

No.	Item	Description
1	Exit Button	Quits the Troubleshooter.
2	Title Bar	Displays the current date of the NA.
3	Tabs	Switch between displaying active events and the event log.
4	Controller Events	Displays current Controller events.
5	User Events	Displays current user-defined events.
6	Display Item Selection	Selects the Event Log Selection Screen to display.
7	Back Button	Returns the display to the NJ/NX-series Controller Status Screen.
8	Screen Shot Button	Captures an image of the displayed screen and stores it in USB memory or an SD Memory Card in PNG format.
9	Save to File Button	Stores the Controller event log of the selected Controller in USB memory or an SD Memory Card in PNG format.
10	Show Detail Button	Displays the detailed screen of the current event log.
11	Log Clear Button	Removes all the Controller Event Log of the selected Controller.
12	Status Bar	Displays information on the Controller that is currently selected.



Precautions for Correct Use

When the Log Clear Button is pressed, all of the event logs, including anything hidden on the screen, will be cleared.

This operation cannot be undone.

Event Source Selection Screen

On this screen, the Functional Modules that are the sources of the errors are selected.

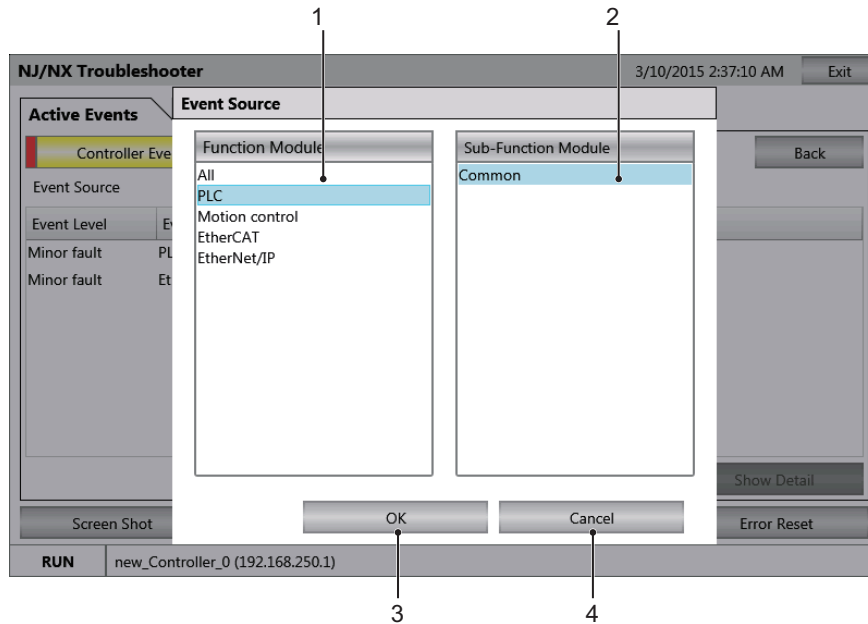

No.	Item	Description
1	Functional Module List	Displays a list of the Functional Modules in the Controller.
2	Sub Functional Module List	Displays a list of the Sub Functional Modules in the Controller.
3	OK Button	Confirms the Functional Module to display.
4	Cancel Button	Cancels the item selection.

Details Screen

This screen displays detailed information on errors or events.

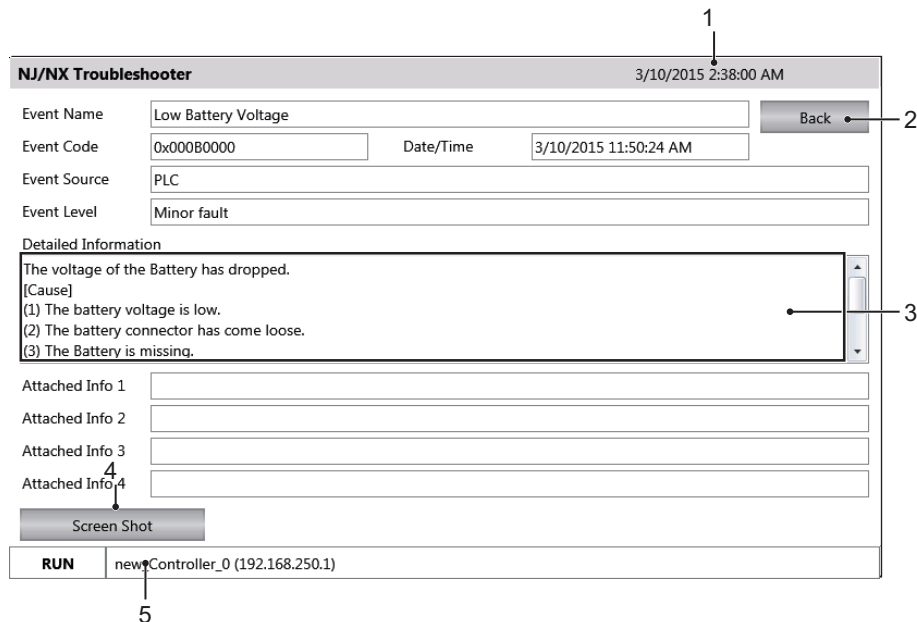

No.	Item	Description
1	Title Bar	Displays the current date of the NA.
2	Back Button	Closes the Details Screen.
3	Details Button	Displays errors and events in detail.
4	Screen Shot Button	Captures an image of the displayed screen and stores it in USB memory or an SD Memory Card in PNG format.
5	Status Bar	Displays information on the Controller that is currently selected.

Operation Settings of the NJ/NX Troubleshooter

The operation settings of the NJ/NX Troubleshooter are set from the Sysmac Studio. Double-click **Troubleshooter** under **Configurations and Setup** in the Multiview Explorer. The Troubleshooter Settings Tab Page will be displayed in the Edit Pane.

● Setting the Display Languages for Errors and Event Logs

The display languages are set in the *Language Mapping Area*.

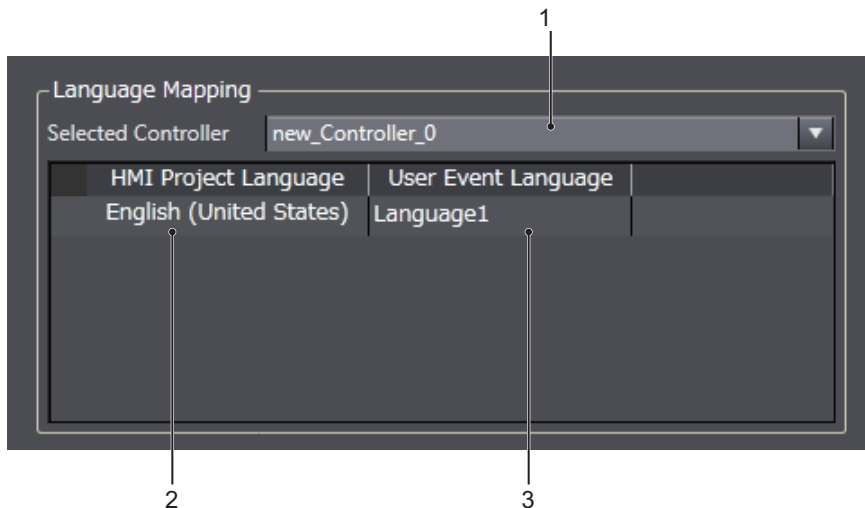

No.	Item	Description
1	Selected Controller	Selects the Controller for which to set the languages.
2	HMI Project Language	Displays the project language that is set in the HMI.
3	User Event Language	Sets the language to use to display user-defined events. Set the corresponding languages for the NA project and the Controller project.

● **Restricting Operation of the Troubleshooter**

You can use passwords to restrict the operation of the Troubleshooter for each function.

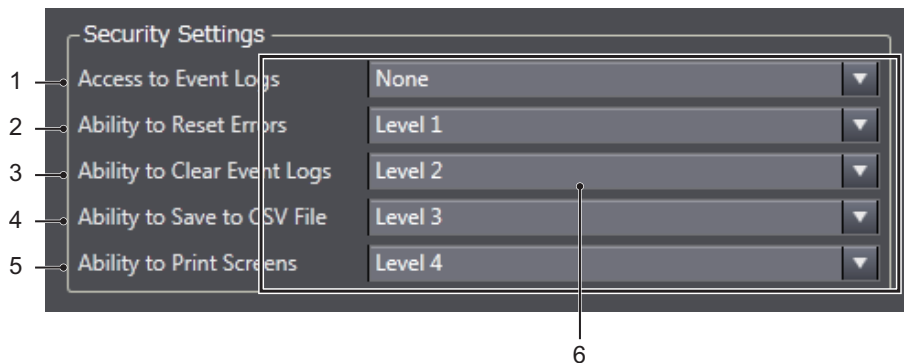

No.	Item	Description
1	Access to Event Logs	Select the level to restrict operations to switch to event log screens.
2	Ability to Reset Errors	Select the level to restrict operations to reset an errors.
3	Ability to Clear Event Logs	Select the level to restrict operations to clear logs.
4	Ability to Save to CSV File	Select the level to restrict operations to save the data to CSV files.
5	Ability to Print Screens	Select the level to restrict operations to capture screens.
6	Restriction Level	Set the levels in the Security Setting Area for the operations to restrict.

4-4-6 Alarm Viewer (Project System Menu)

The following two functions are provided to display alarms.

Item	Description
Active HMI User Alarms	Displays current user alarms.
Historical HMI User Alarms	Displays the user alarm log.

From the Alarm Viewer Screen, you can tap any of the icons for functions to display the individual function screens.

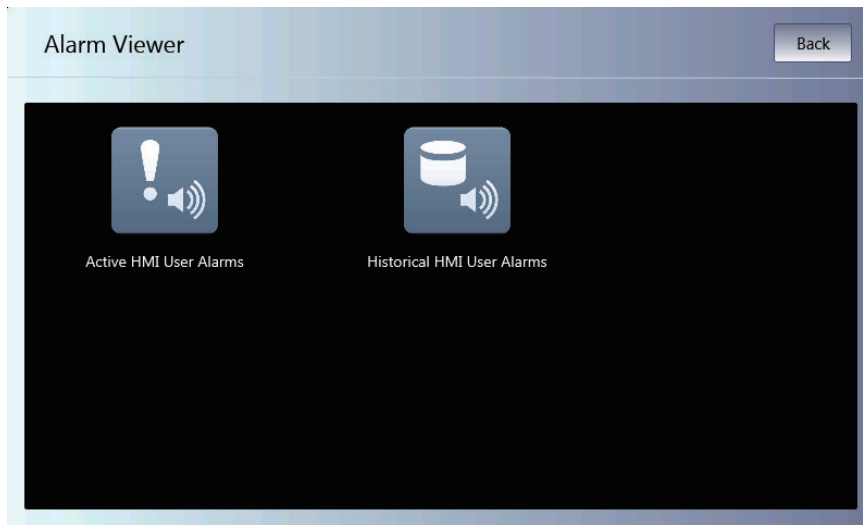

- Active HMI User Alarms

This screen displays a table of the current user alarms.



No.	Item	Description
(a)	Active HMI User Alarm List	Displays a table of the current user alarms.
(b)	Show Details	Displays detailed information on the selected user alarm.

• Alarm Details Screen

This screen displays detailed information on a selected user alarm.

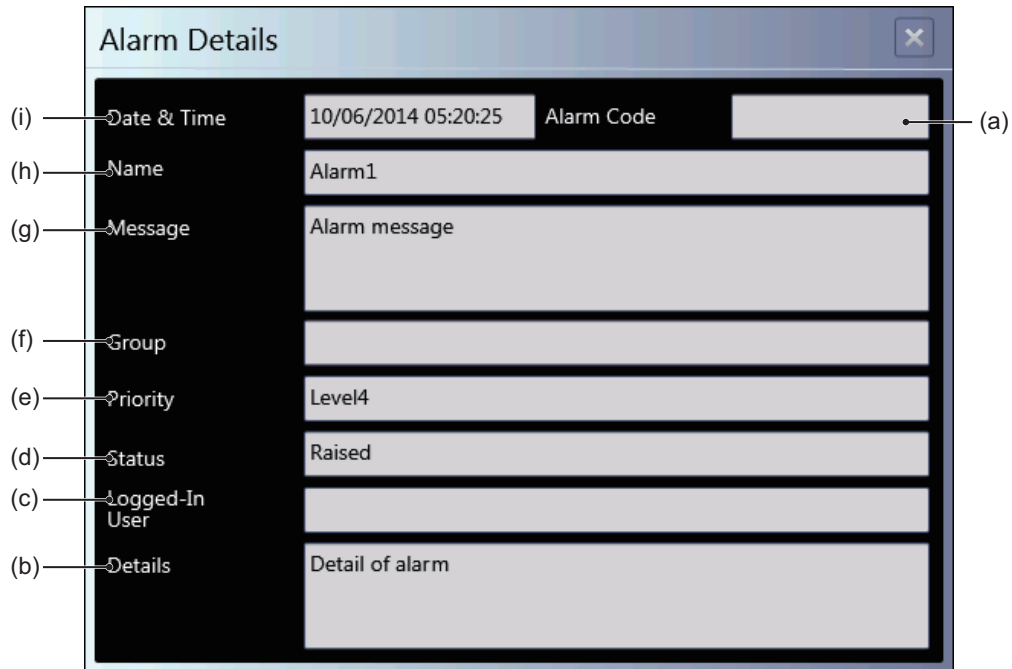

No.	Item	Description
(a)	Alarm Code	Displays the alarm code of the user alarm that occurred.
(b)	Details	Displays the details on the user alarm that occurred.
(c)	Logged-in User	Displays the name of the user that is currently logged in.
(d)	Status	Displays the status of the user alarm that occurred.
(e)	Priority	Displays the priority of the user alarm that occurred.
(f)	Group	Displays the group of the user alarm that occurred.
(g)	Message	Displays the message for the user alarm that occurred.
(h)	Name	Displays the name of the user alarm that occurred.
(i)	Date&Time	Displays the time and date that the user alarm occurred.

• Historical HMI User Alarms Screen

This screen displays a log of the user alarms.

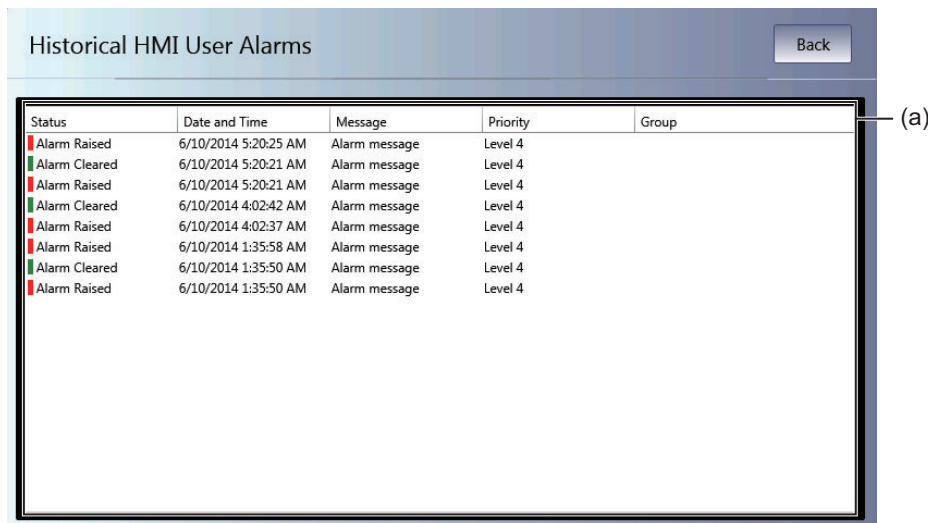

No.	Item	Description
(a)	Historical HMI User Alarm	Displays a log of the user alarms.

4-4-7 Project System Menu Settings (Project System Menu)

You can use the System Menu settings to set the following items.

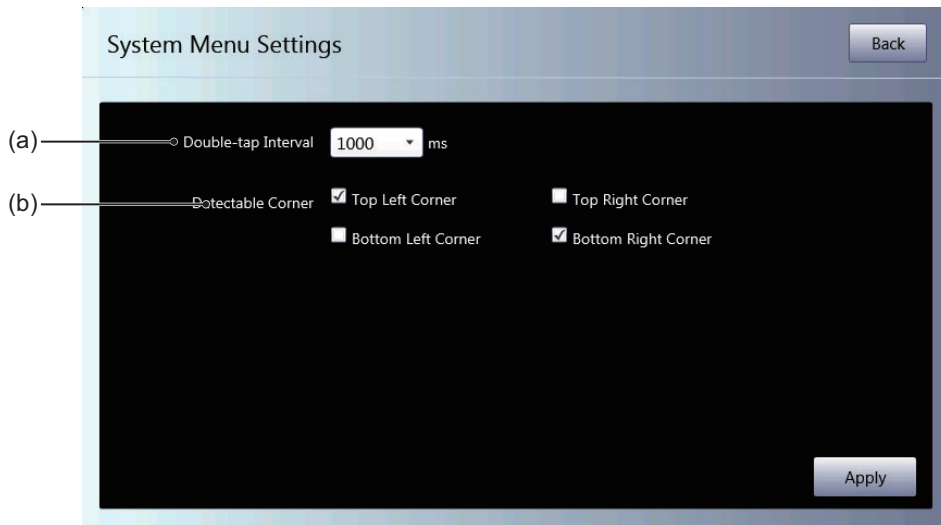

No.	Item	Description
(a)	Double-tap Interval	Sets the double-tap interval for the operation to start the System Menu.
(b)	Detectable Corner	Sets the double-tap detection positions for the operation to start the System Menu.

4-4-8 Print Settings (Project System Menu)

You can use the print settings to set the following items.

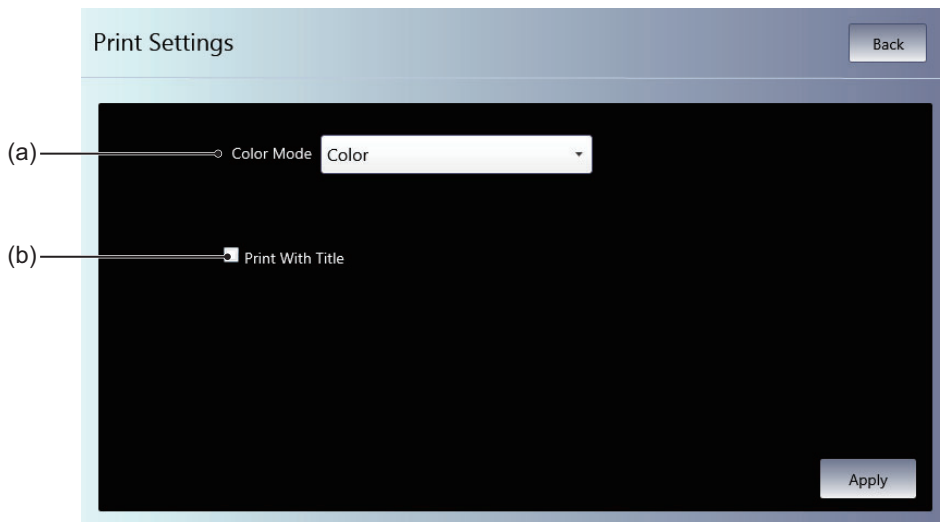

No.	Item	Description
(a)	Color Mode	Select from among the following options for colors and/or reverse display of printing or capturing screens: <ul style="list-style-type: none"> • Color • Grayscale • Reverse Grayscale
(b)	Print With Title	Select this check box to insert a screen title during printing/capturing of the screen.

4-4-9 Buzzer Settings (Project System Menu)

You can use the buzzer settings to set the following items.

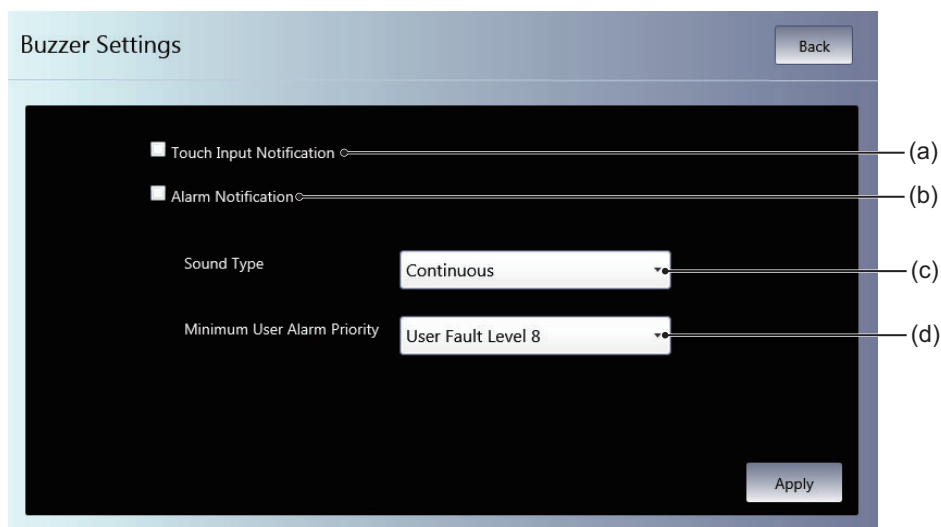

No.	Item	Description
(a)	Touch Input Notification	Select this check box to sound the buzzer when an object is touched.
(b)	Alarm Notification	Select this check box to sound the buzzer when an alarm occurs.
(c)	Sound Type	Select the buzzer type from among the following options: <ul style="list-style-type: none"> • Continuous • Intermittent Short Pulse • Intermittent Long Pulse
(d)	Minimum User Alarm Priority	Select the user fault level that sounds the buzzer from among the following options: <ul style="list-style-type: none"> • User Fault Level 1 • User Fault Level 2 • User Fault Level 3 • User Fault Level 4 • User Fault Level 5 • User Fault Level 6 • User Fault Level 7 • User Fault Level 8 • User Information

4-4-10 Date & Time Settings (Device System Menu)

You can use the date & time settings to set the following items.

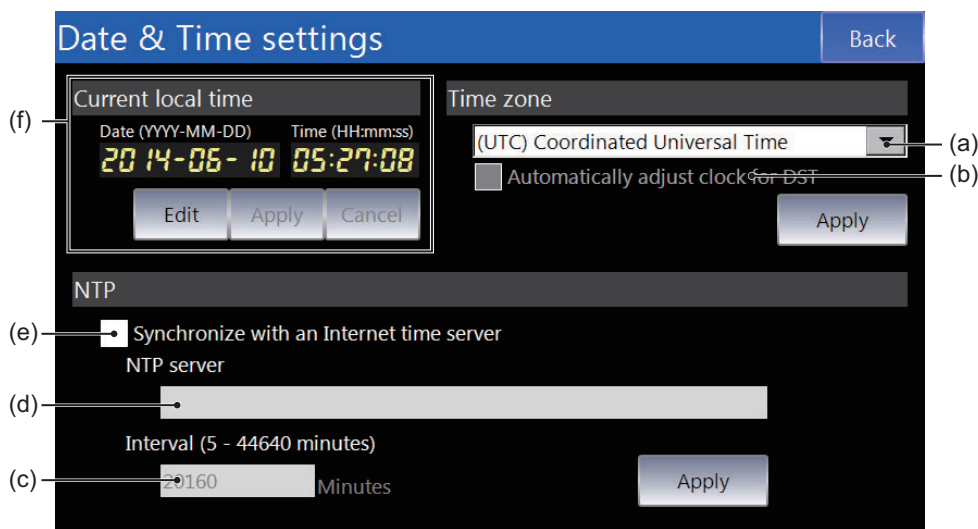

No.	Item	Description
(a)	Time Zone	Sets the time zone.
(b)	Automatically adjust clock for DST	Select this check box to automatically compensate for daylight saving time.
(c)	Interval	Sets the interval for synchronizing with the NTP server.
(d)	NTP Server	Sets the IP address of the NTP server.
(e)	Synchronize with an Internet time server	Select this check box to synchronize the time with a time server.
(f)	Current Local Time	Sets the current time.

4-4-11 Language Settings (Device System Menu)

You can use the language settings to set the following items.

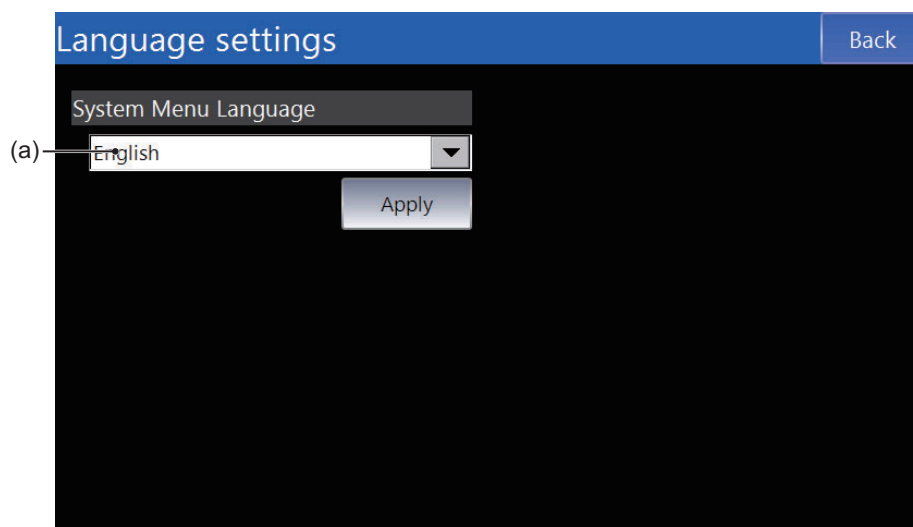

No.	Item	Description
(a)	System Menu Language	Sets the system language. The language settings made from the Project System Menu take priority.

4-4-12 Interface Settings (Device System Menu)

You can use the interface settings to set communications for the NA Unit.

From the Interface Settings Screen, you can tap any of the icons for settings to display the individual setting screens.

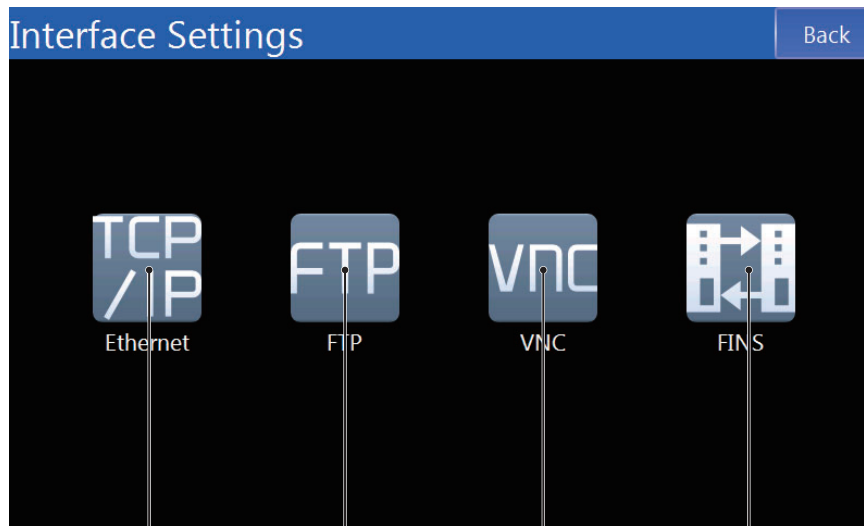

No.	Item	Description
(a)	Ethernet	Sets the IP address of the NA Unit and other settings.
(b)	FTP	Makes settings for the FTP server.
(c)	VNC	Makes settings for VNC.
(d)	FINS	Makes settings for FINS.

Ethernet

This screen is used to set the Ethernet port IP address and other settings for Ethernet.

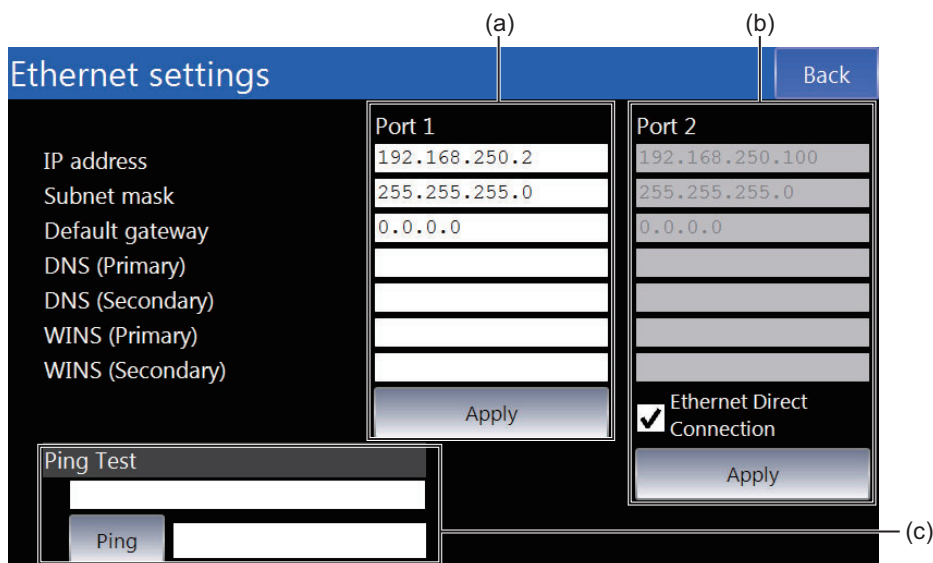

No.	Item	Description
(a)	Ethernet Port 1 Settings	Sets the IP address and other settings for Ethernet port 1.
(b)	Ethernet Port 2 Settings	Sets the IP address and other settings for Ethernet port 2. This setting is ignored if you select the <i>Ethernet Direct Connection</i> Check Box.
(c)	Ping Test	Executes a ping test for the specified address.

FTP

This screen is used to make settings for the FTP server.

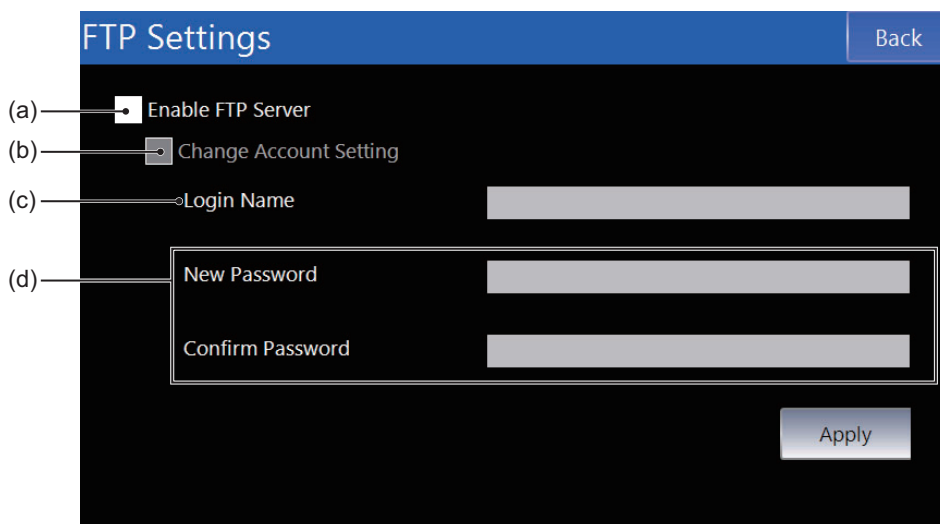

No.	Item	Description
(a)	Enable FTP server	Select this check box to use the FTP server.
(b)	Change Account Setting	Select this check box to change the account.
(c)	Login Name	Sets the login name.
(d)	Password	Sets the password.

VNC

This screen is used to make settings for VNC.

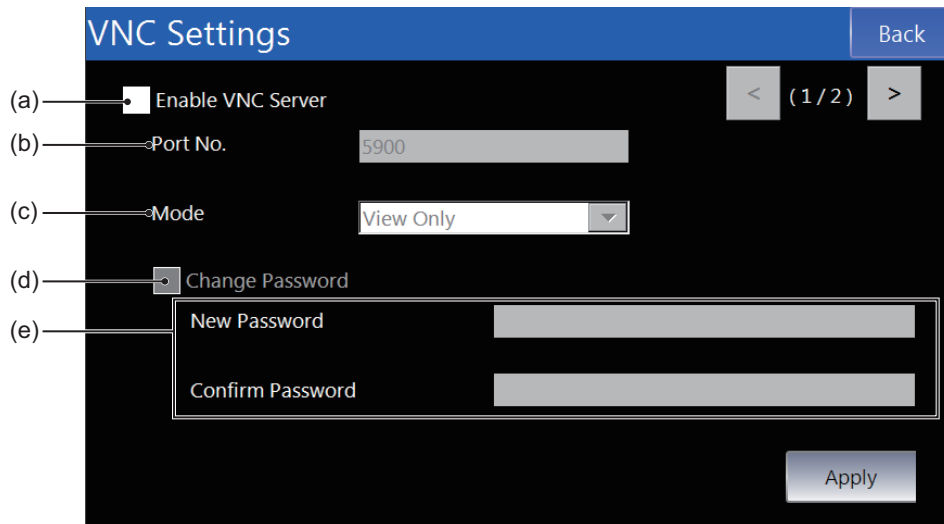

- VNC Settings (1/2)

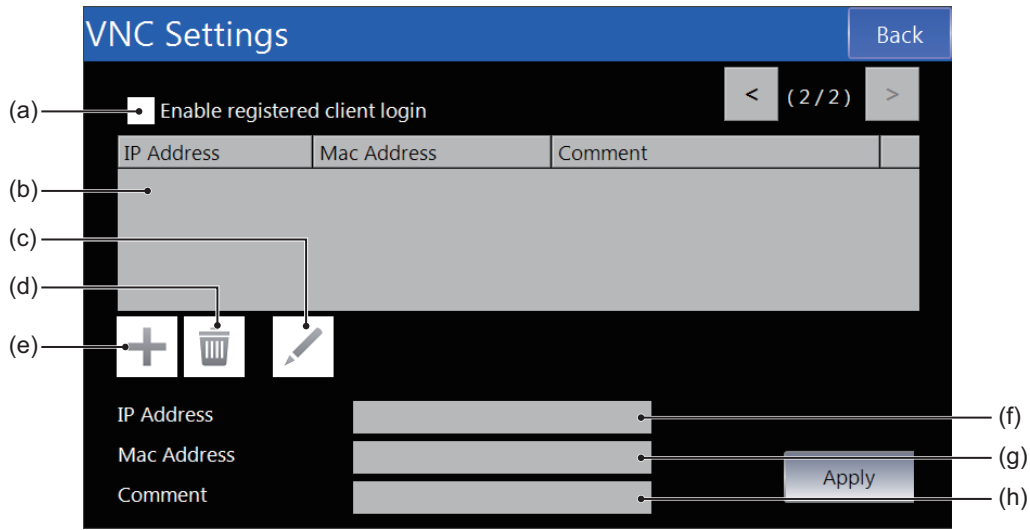

No.	Item	Description
(a)	Enable VNC Server	Select this check box to use the VNC.
(b)	Port No.	Sets the port number.
(c)	Mode	Sets the mode.
(d)	Change Password	Select this check box to change the password.
(e)	Password	Sets the password.

• VNC Settings (2/2)



No.	Item	Description
(a)	Enable registered client login	Select this check box to set login restrictions.
(b)	List of clients	Lists the clients registered at present.
(c)		Edits the selected client.
(d)		Deletes the selected client.
(e)		Adds a new client.
(f)	IP Address	Sets the IP address of a client.
(g)	MAC Address	Sets the MAC address of a client.
(h)	Comment	Sets a comment for a client.

FINS

This screen is used to make settings for FINS.

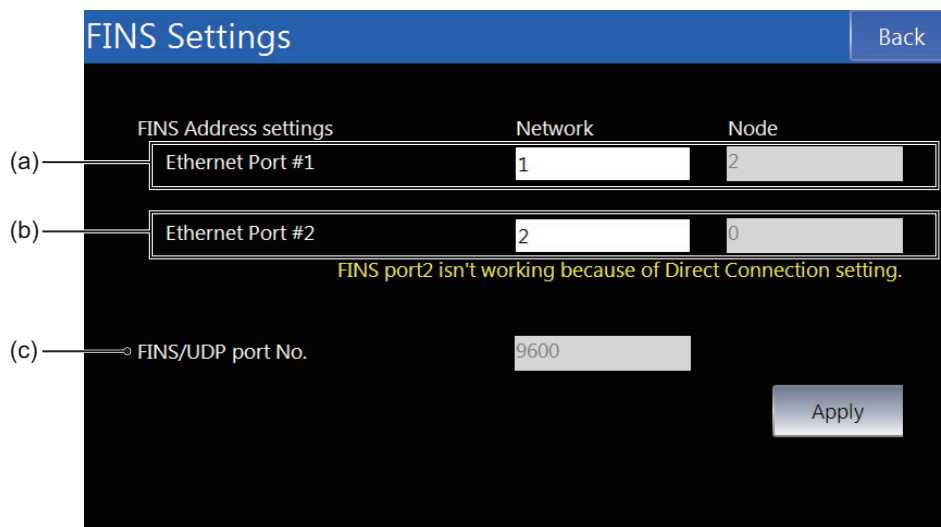

No.	Item	Description
(a)	Ethernet Port 1 Settings	Sets the FINS network address for Ethernet port 1. The node address is automatically created based on the IP address.
(b)	Ethernet Port 2 Settings	Sets the FINS network address for Ethernet port 2. The node address is automatically created based on the IP address.
(c)	FINS/UDP Port No.	Displays the FINS/UDP port number.

4-4-13 Brightness Settings (Device System Menu)

You can use the brightness settings to set the following items.

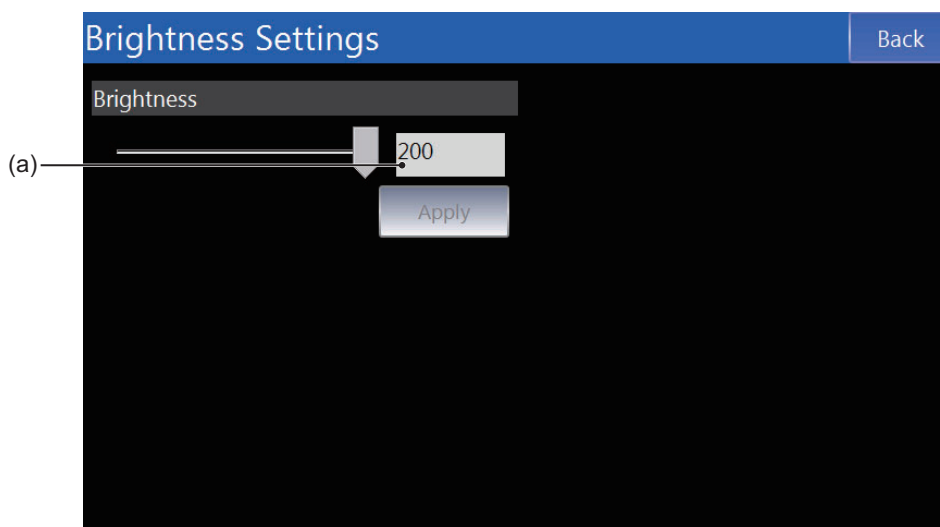

No.	Item	Description
(a)	Brightness	Sets the screen brightness.

4-4-14 Transfer Operations (Device System Menu)

This screen is used to transfer the project and other data.

You can tap any of the icons for settings to display the individual setting screens.

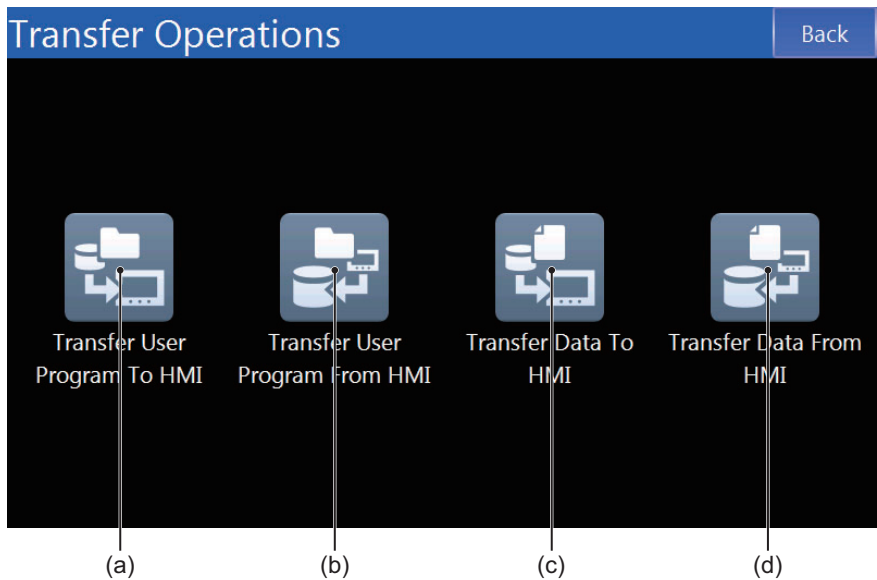

No.	Item	Description
(a)	Transfer User Program to HMI	Downloads the project.
(b)	Transfer User Program from HMI	Uploads the project.
(c)	Transfer Data to HMI	Downloads various types of data.
(d)	Transfer Data from HMI	Uploads various types of data.

Transfer User Program to HMI

This screen is used to download the project from an SD Memory Card or USB Memory Device.

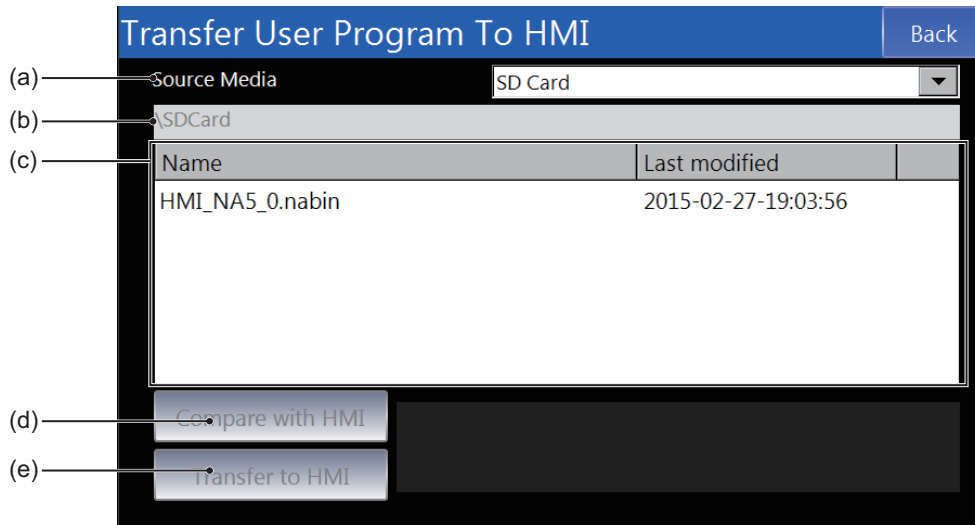

No.	Item	Description
(a)	Source Media	Sets the media that contains the project to download.
(b)	Path	Displays the path of the folder displayed at (c).
(c)	Folder Contents	Displays the files and folders in the currently open folder.
(d)	Compare with HMI	Compares between the selected project and the HMI.
(e)	Transfer to HMI	Downloads the selected project to the HMI.

Transfer User Program from HMI

This screen is used to upload the project to an SD Memory Card or USB Memory Device.

(a) — Destination Media: SD Card

(b) — SDCard

(c) — Name | Last modified

(d) — File Name: HMI_NA_2014_06_10.nabin

(e) — Transfer From HMI

No.	Item	Description
(a)	Destination Media	Sets the media to which to upload the project.
(b)	Path	Displays the path of the folder displayed at (c).
(c)	Current Folder	Displays the files and folders in the currently open folder.
(d)	Destination File	Sets the file name.
(e)	Transfer from HMI	Uploads the selected project from the HMI to the destination media.



Precautions for Correct Use

Projects that are downloaded with Sysmac Studio version 1.10 and projects that are downloaded when the *Transfer source code to the NA device* Check Box is not selected cannot be read by the Sysmac Studio.

You can use projects like these (i.e., projects that do not contain the source code) to create duplicates of the NA Unit with the same project or as backups to restore the NA Unit without using a computer if the NA Unit fails.

Transfer Data to HMI

This screen is used to download text, videos, or other data from an SD Memory Card or USB Memory Device.

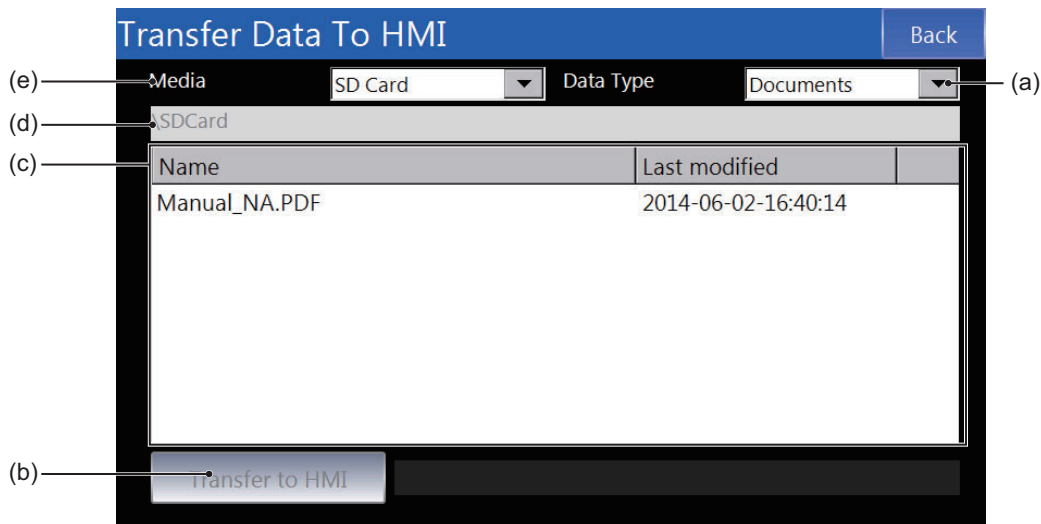

No.	Item	Description
(a)	Data Type	Sets the file type. Only files with the specified file type are displayed at (c).
(b)	Transfer to HMI	Downloads the data.
(c)	Current Folder	Displays the files and folders in the currently open folder.
(d)	Path	Displays the path of the folder displayed at (c).
(e)	Media	Sets the media that contains the data to download.

Transfer Data from HMI

This screen is used to upload recipes, videos, or other data to an SD Memory Card or USB Memory Device.

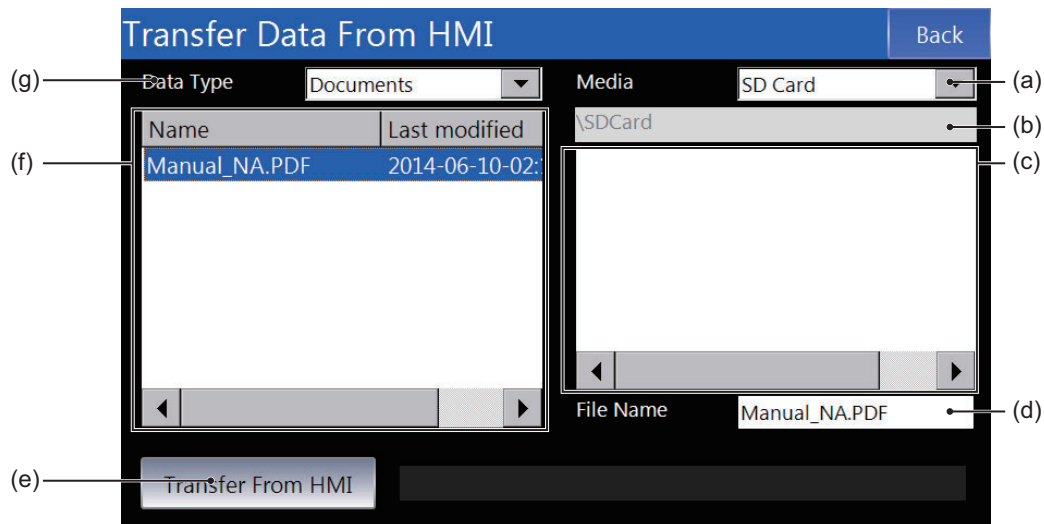

No.	Item	Description
(a)	Media	Sets the media to which to upload the data.
(b)	Path	Displays the path of the folder displayed at (c).
(c)	Destination Folder	Displays the files and folders in the currently open destination folder.
(d)	File Name	Sets the name of the file at the destination.
(e)	Transfer from HMI	Uploads the data.
(f)	Target Files	Displays a list of the files that you can upload.
(g)	Data Type	Sets the file type. Only files with the specified file type are displayed at (c) and (f).

4-4-15 Hardware Diagnostics (Device System Menu)

This screen is used to check the operation of the touch panel and to calibrate it.

You can tap any of the icons to access a function.

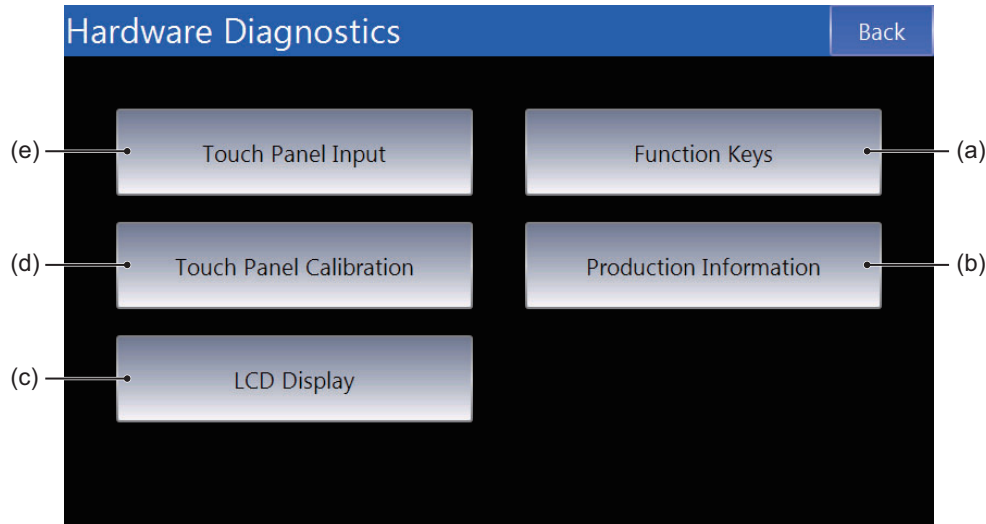

No.	Item	Description
(a)	Function Keys	Checks the operation of the function keys.
(b)	Production Information	Displays product information.
(c)	LCD Display	Displays a color bar to use to check the LCD.
(d)	Touch Panel Calibration	Calibrates the touch panel.
(e)	Touch Panel Input	Checks touch panel inputs.

Function Keys

This screen is used to check the operation of the function keys.

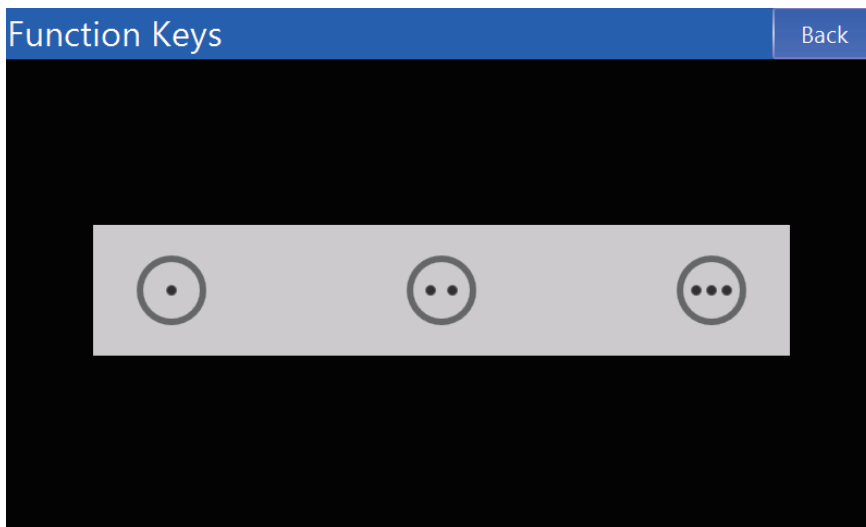

Production Information

This screen displays product information.

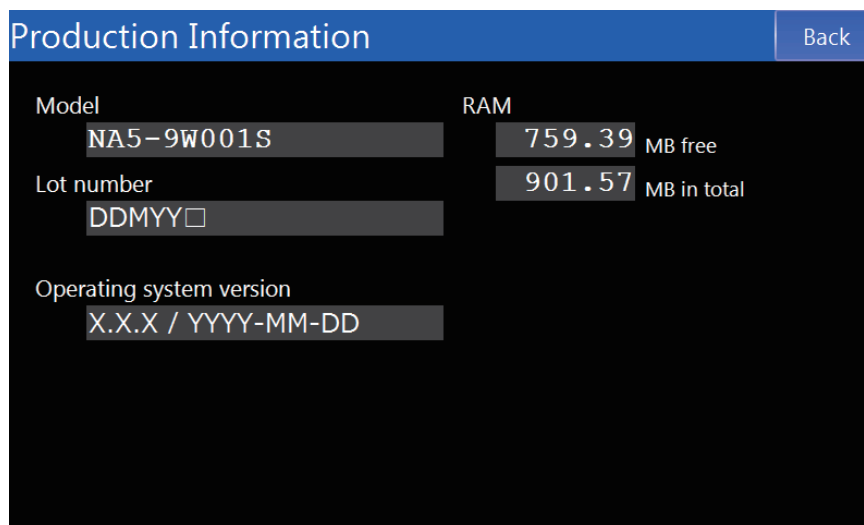

LCD Display

A color bar is displayed. Use this to check the LCD.

Tap the screen to move to the next display.



Touch Panel Calibration

This screen is used to calibrate the touch panel. Tap the plus signs that are displayed.

To cancel, double-tap any position.

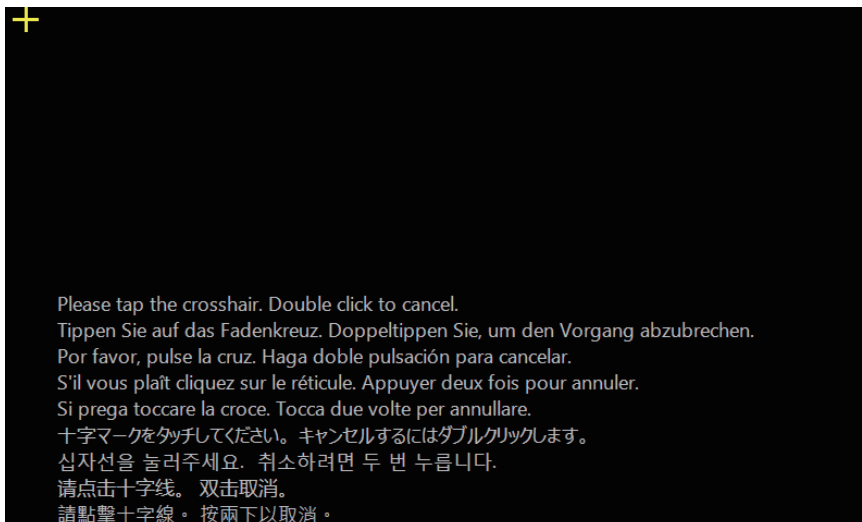

Touch Panel Input

The locations that are touched are displayed as dots. Use this to check the operation of the touch panel.

To end, double-tap any position.

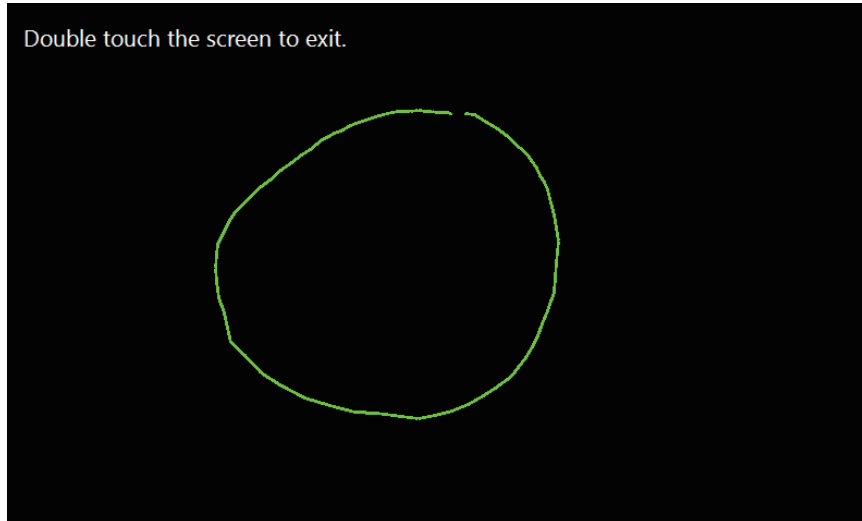

4-4-16 Production Information (Device System Menu)

This screen displays product information.

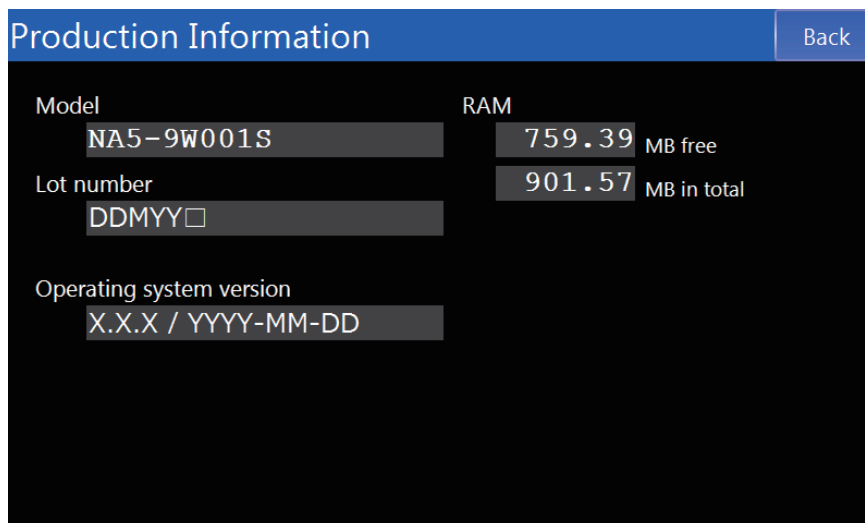

5

Troubleshooting

This section describes troubleshooting methods for errors that may occur in the NA-series Programmable Terminal.

5-1	Operation after an Error	5-2
5-1-1	Checking NA Unit Status	5-2
5-1-2	Fatal Errors in the NA Unit	5-2
5-1-3	Nonfatal Errors in the NA Unit	5-3
5-2	Troubleshooting	5-4
5-2-1	Confirming NA Unit Operation	5-4
5-2-2	Correcting Fatal Errors in the NA Unit	5-4
5-2-3	Troubleshooting Non-fatal Errors	5-5
5-2-4	Causes and Correction When You Cannot Go Online from the Sysmac Studio	5-5
5-2-5	Troubleshooting NA Unit Errors	5-9

5-1 Operation after an Error

This section describes the error status of the NA-series Programmable Terminal and the operation that occurs after an error is detected. Refer to *5-2 Troubleshooting* on page 5-4 for details on corrections for specific errors.

5-1-1 Checking NA Unit Status

You can check the operating status of an NA Unit with the RUN indicator on the right side of the front panel.

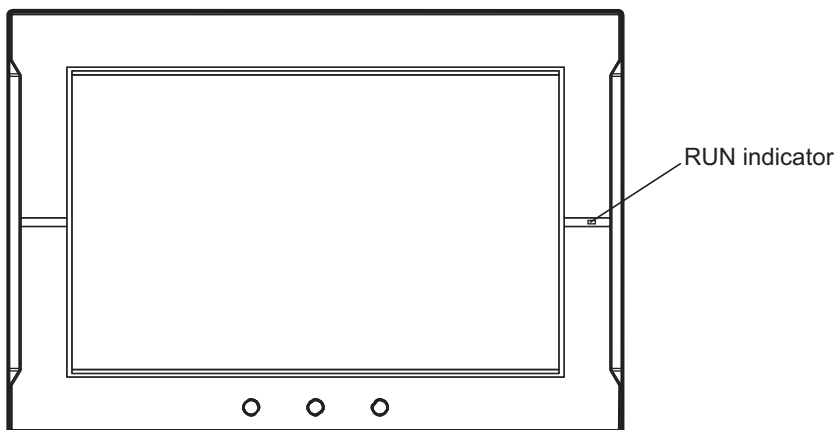

RUN indicator		Status
Status	Color	
Not lit.	---	Power is not correctly supplied to the NA Unit.
Lit.	Green	The NA Unit is operating normally.
Lit.	Red	A fatal error ^{*1} occurred in the NA Unit. Refer to <i>5-1-2 Fatal Errors in the NA Unit</i> on page 5-2 for details.
Flashing.	Red	A nonfatal error ^{*1} occurred in the NA Unit. Refer to <i>5-1-3 Nonfatal Errors in the NA Unit</i> on page 5-3 for details.

*1. An error is any status in which normal operation is not performed. Errors include hardware problems, system program crashes, and user data errors.

5-1-2 Fatal Errors in the NA Unit

Fatal Errors in the NA Unit

Some errors are fatal and prevent the NA Unit from operating. This section describes these fatal errors, which cause the operation of the NA Unit to stop.

- **If any of the following errors occur, the Sysmac Studio cannot go online with the NA Unit and communications connections with connected devices are not possible.**

- Power Supply Error

Power is not supplied, the voltage is outside of the allowable range, or the power supply section is faulty.

- Hardware Error
A hardware error is any hardware problem except those in the power supply.
- System Program Error
The system program is corrupted and normal operation is not possible.
- **If any of the following errors occur, the Sysmac Studio can go online with the NA Unit, but communications connections with connected devices are not possible.**
 - Runtime Error
The middleware that executes the project is not operating normally.
 - Project Error
There is a fatal error in the project, so normal operation is not possible.

5-1-3 Nonfatal Errors in the NA Unit

Nonfatal Errors in the NA Unit

If there are no problems in the hardware or system program, the NA Unit will operate even if one of these errors occurs. This section describes nonfatal errors.

- **If any of the following errors occur, the Sysmac Studio can go online with the NA Unit, but communications connections with connected devices are not possible.**
 - Tag Verification Error
The tags registered in the NA Unit do not agree with the tags registered in the connected device.
 - Connected Device Communications Error
Normal communications are not possible with a connected device.
- **If any of the following errors occur, the Sysmac Studio can go online with the NA Unit and communications connections with connected devices are possible.**
 - Low Battery Voltage
The voltage of the Battery has decreased.
 - SD Memory Card or USB Memory Device Error
There is an error in the SD Memory Card or USB Memory Device inserted in the NA Unit.

5-2 Troubleshooting

This section provides basic error identification, troubleshooting flowcharts, and error corrections. Use them when an error occurs in the NA Unit.

5-2-1 Confirming NA Unit Operation

When an error occurs in the NA Unit, use the following flowchart to determine whether the error is a fatal error or a non-fatal error.

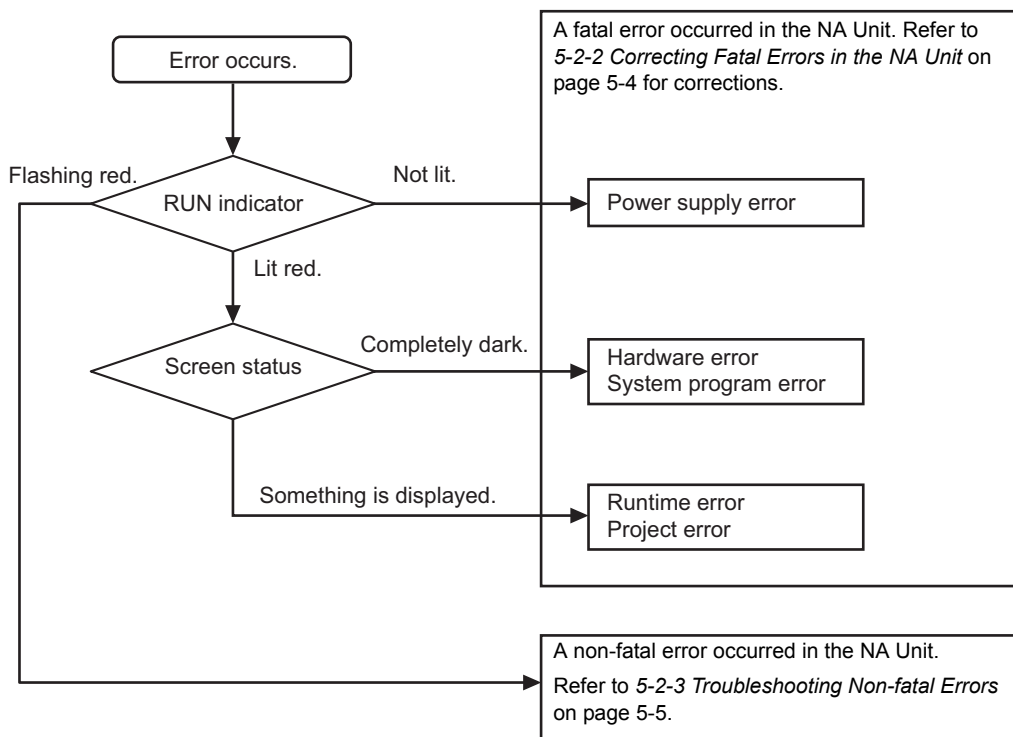

5-2-2 Correcting Fatal Errors in the NA Unit

● Power Supply Error

Check the following items:

- Is the NA Unit correctly connected to the external DC power supply?
- Is the voltage supplied from the external DC power supply within the allowable range?

● Hardware Error

Turn OFF the power supply, disconnect all devices connected to the NA Unit, and then turn the power supply back ON. If the NA Unit operates normally, the cause of the error is in a disconnected device.

● System Program Error

Execute system recovery.

● Runtime Error

Download the project again. If you cannot download the program, execute system recovery.

- **Project Error**

Download the project again.

If you confirmed that there are no problems with the above items and the NA Unit still does not operate normally, inquire at the contact given on the back of this manual.

5-2-3 Troubleshooting Non-fatal Errors

- **Tag Verification Error**

Align the tags registered in the NA Unit with the tags registered in the connected device.

- **Connected Device Communications Error**

- Check the HMI Settings and connected device settings to see if they allow normal communications.
- If a router or other network devices are installed, check the settings of the router or other network devices to see if they allow normal communications.
- If a connected device uses data links, check to see if the processing capacity of the connected device and the network band are sufficient to handle them.

- **Low Battery Voltage**

Replace the Battery.

- **Minor Project Error**

Download the project again.

- **SD Memory Card or USB Memory Device Error**

Replace the SD Memory Card or USB Memory Device with a normal one..

5-2-4 Causes and Correction When You Cannot Go Online from the Sysmac Studio

The following table lists the possible causes when you cannot go online with the NA Unit from the Sysmac Studio.

Cause	Description	Correction
Incorrect settings or faulty communications path	There is a mistake in the settings that the Sysmac Studio uses to go online with the NA Unit. Or, the communications path is faulty.	Refer to <i>Troubleshooting Incorrect Settings and Faulty Communications Path</i> on page 5-6.
Fatal Errors in the NA Unit	A fatal error occurred in the NA Unit.	Refer to <i>5-2-1 Confirming NA Unit Operation</i> on page 5-4.
High load on the NA Unit	The load on the NA Unit is too high and time cannot be obtained to connect with the Sysmac Studio.	Execute system recovery, reduce the project load, and then download the project again.

Troubleshooting Incorrect Settings and Faulty Communications Path

This section provides troubleshooting methods for incorrect settings, faulty communications paths, and high NA Unit loads.

● Direct Connection with USB Port

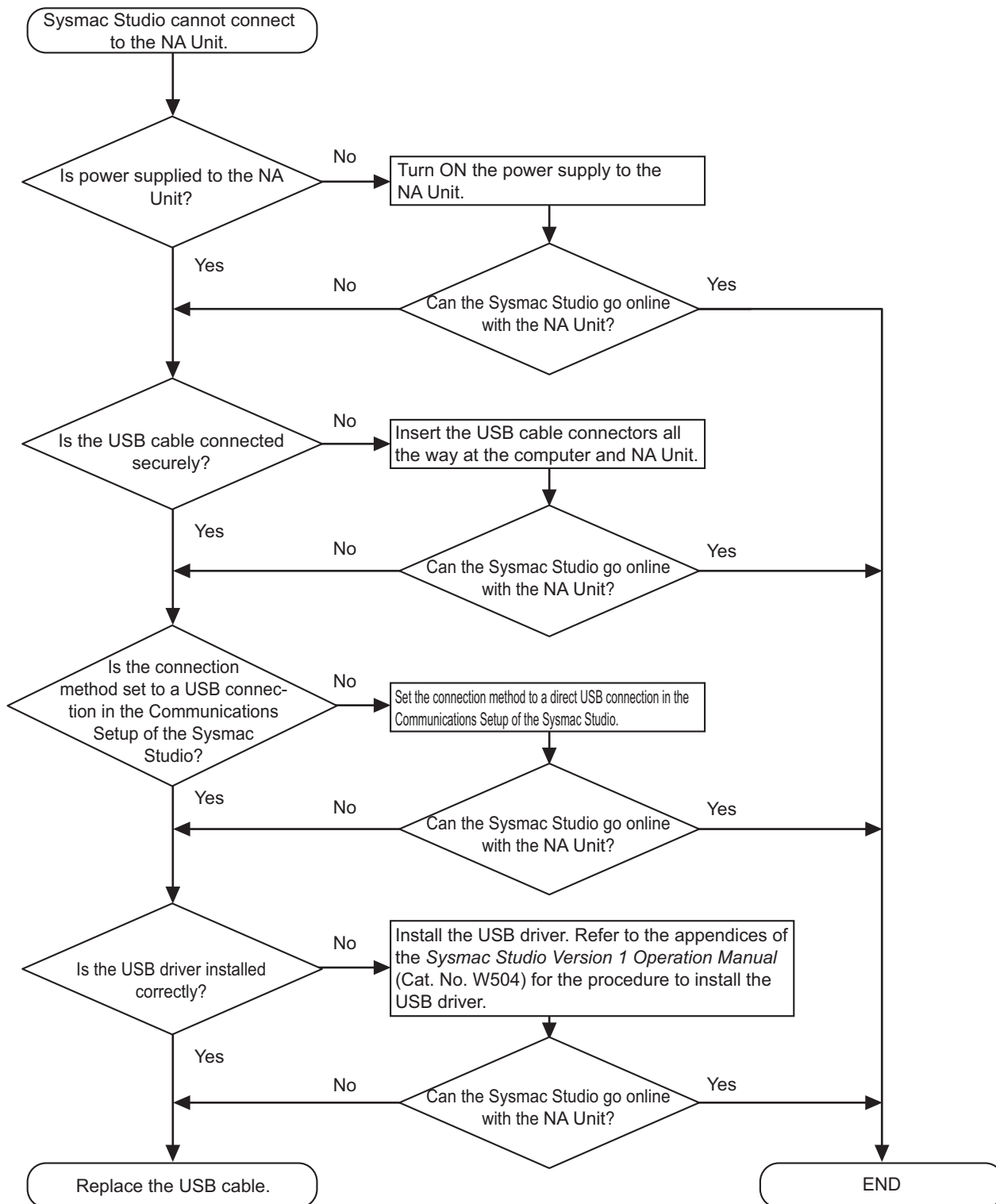

● Ethernet – Direct Connection

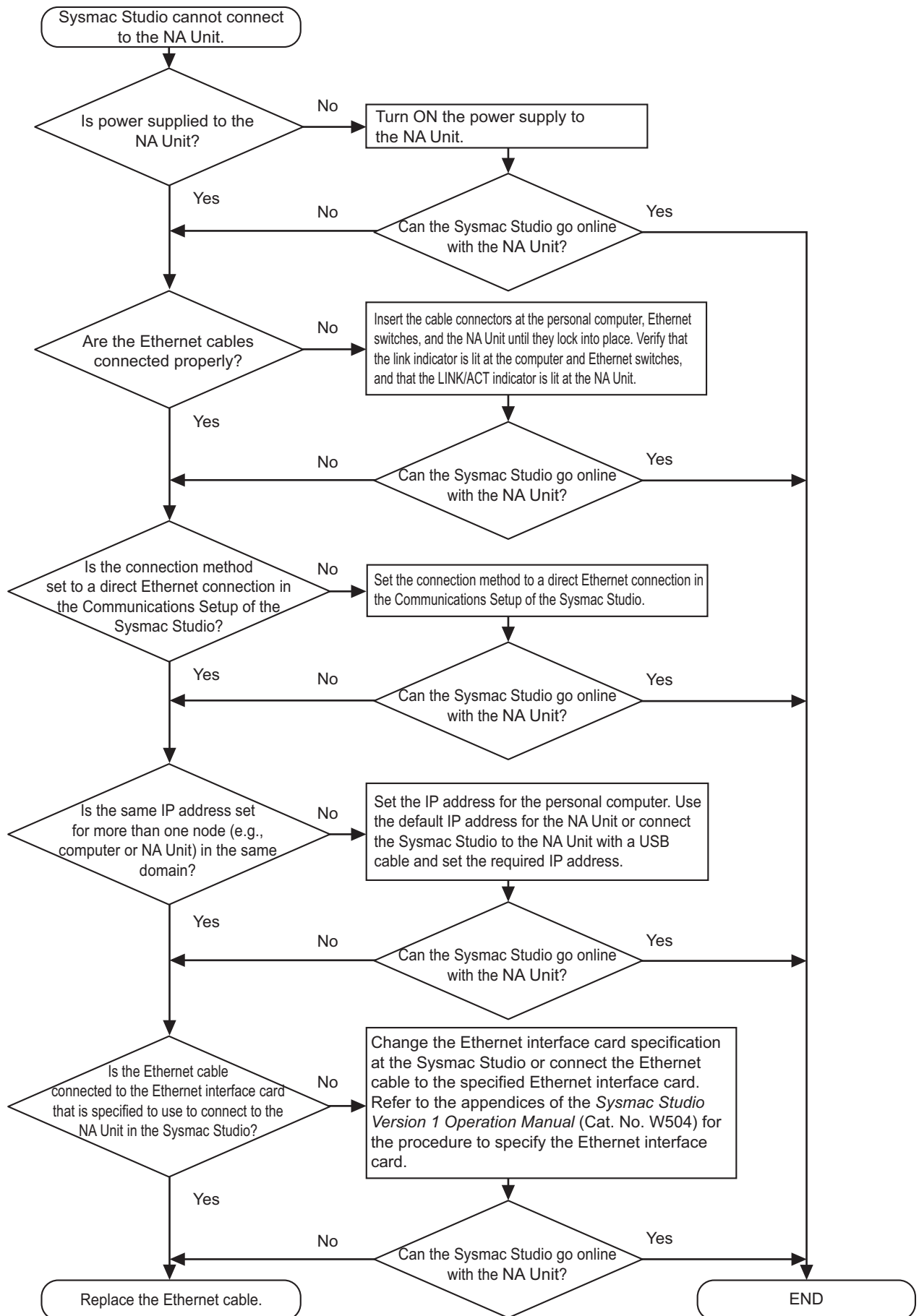

● Ethernet – Hub Connection

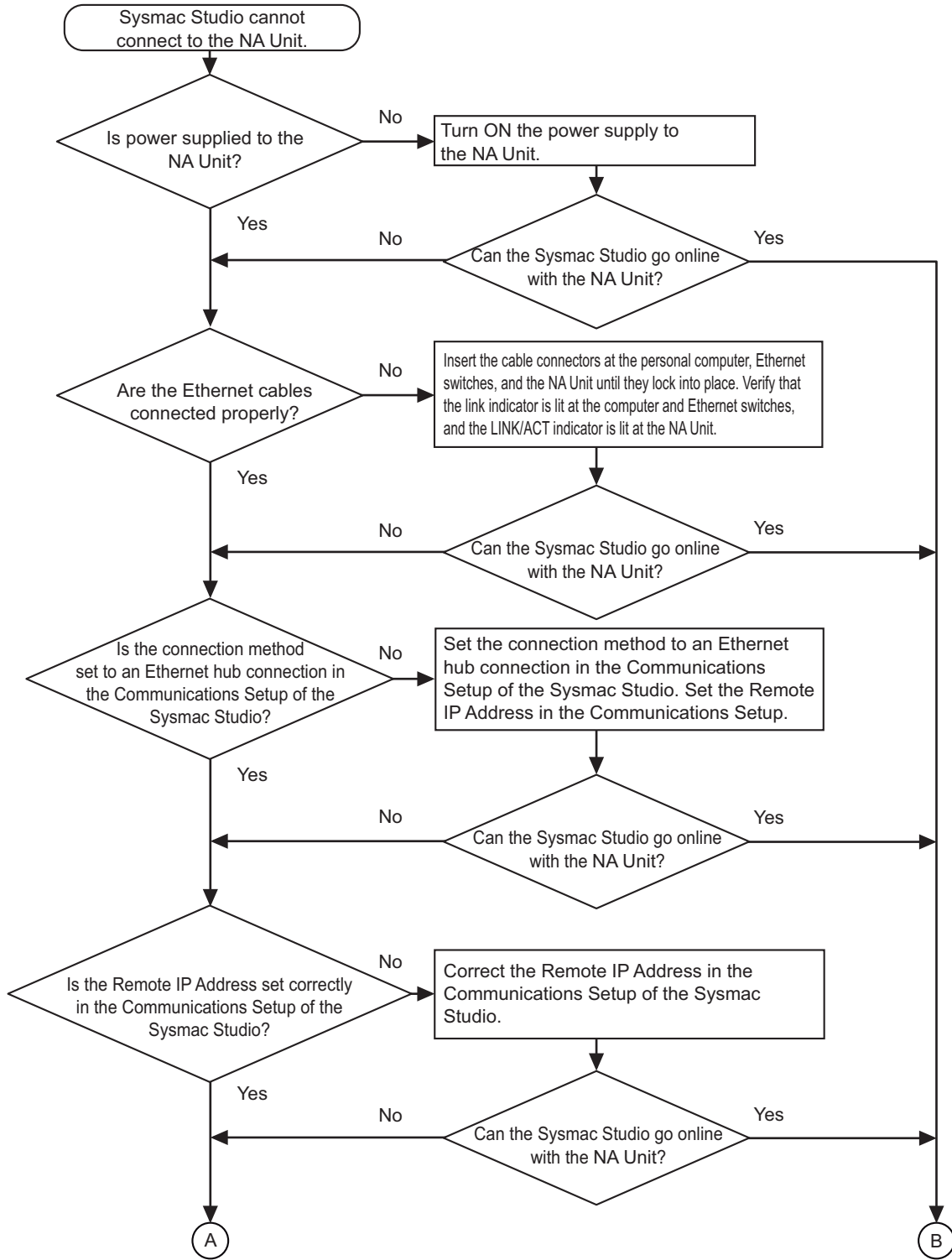

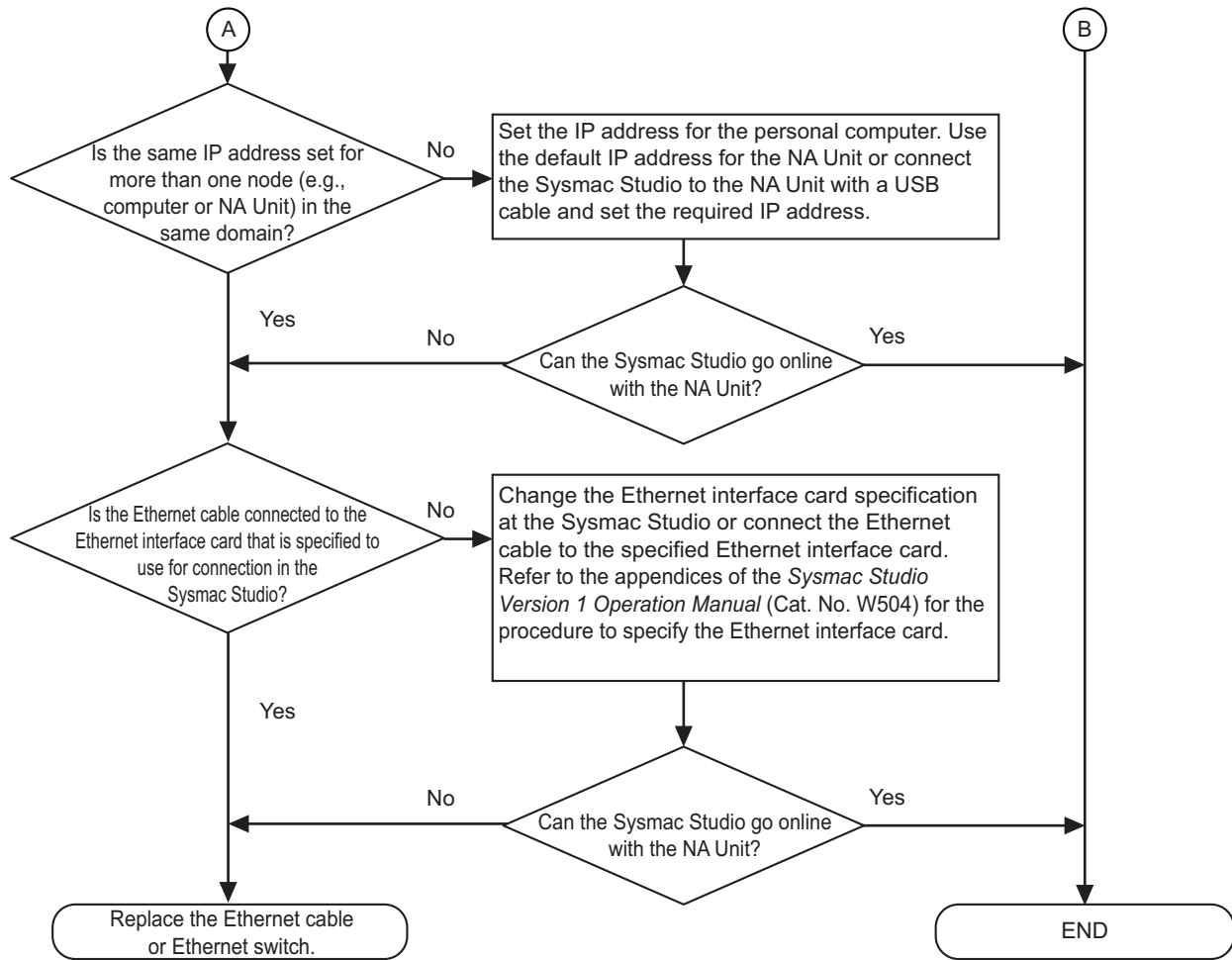

5-2-5 Troubleshooting NA Unit Errors

This section describes how to troubleshoot errors in the NA Unit.

NA Unit Startup

NA Unit symptom	Cause	Correction
The indicator does not light.	Power is not supplied.	Confirm the connection location and correctly supply power.
	The supplied voltage is outside the allowable range.	Check the supplied voltage and supply the correct voltage.
	The power supply fuse has burnt out.	The NA Unit needs to be repaired. Inquire at the contact given on the back of this manual.
	There is an error in the power supply section.	The NA Unit may be faulty. Inquire at the contact given on the back of this manual.
	The brightness of the screen has decreased.	Increase the screen brightness setting in the project and download the project again.

NA Unit symptom	Cause	Correction
The indicators light red and nothing is displayed on the screen.	The system program is corrupted. (This is a fatal error.)	Execute system recovery. If the problem recurs after you execute system recovery, inquire at the contact given on the back of this manual.
	There is a problem with the connected device.	Disconnect all devices except for the power supply and restart the NA Unit. If the NA Unit starts normally, connect one device at a time and restart the NA Unit each time to see which device is causing the problem.
The indicators light red and an initialization message is displayed on the screen.	The runtime middleware is corrupted.	Execute system recovery. If the problem recurs after you execute system recovery, inquire at the contact given on the back of this manual.
The indicators light red and an initialization failed message is displayed on the screen.	Initializing runtime middleware failed.	Download the project again and update the runtime middleware. If the problem recurs after the download, execute system recovery.
The indicators light red and an error dialog box with a blue title bar is displayed.	The project is corrupted.	Download the project again. If the problem recurs after the download, execute system recovery.
The indicators light red and normal operation is performed.	Startup failed.	Restart the NA Unit.
The indicators flash red and <i>E_COM_002: Tag comparison error with xxx</i> error message is displayed.	The tags registered in the NA Unit do not agree with the tags in the connected device.	Align the tags in the NA Unit with the tags registered in the connected device.

Errors during NA Unit Operation

● Errors Determined from NA Unit Symptoms

NA Unit symptom	Cause	Correction
The indicators light red and operation stops.	There is not enough memory.	Change the project to reduce memory usage.
The indicators flash red and normal operation is performed.	The voltage of the Battery has decreased.	Replace the Battery. Refer to <i>6-2 Replacing the Battery</i> on page 6-5 for the battery replacement procedure.
The indicators flash red and the SD Memory Card or USB Memory Device cannot be accessed.	There is an error in the SD Memory Card or USB Memory Device.	Replace the SD Memory Card or USB Memory Device in the NA Unit with a normal one.
Nothing is displayed on the screen.	The screen saver was activated.	This is not an error. Touch the screen or press a function key.
	The Backlight has failed.	The Backlight needs to be replaced. Inquire at the contact given on the back of this manual.
	The screen is too dark.	Increase the screen brightness setting in the project and download the project again.
The touch panel does not respond.	External noise caused a malfunction.	Reset the NA Unit and then implement noise countermeasures in the wiring.
	The touch panel is broken.	Use the Touch Panel Input Icon on the System Menu to test the touch panel. If an error is found, inquire at the contact given on the back of this manual.

NA Unit symptom	Cause	Correction
The display is dark.	The screen is too dark.	<ul style="list-style-type: none"> • Increase the brightness of the screen in the brightness setting on the System Menu. • Increase the screen brightness setting in the project and download the project again.
	The Backlight is faulty or has reached the end of its life.	The Backlight needs to be replaced. Inquire at the contact given on the back of this manual.
Numbers or characters are refreshed too slowly.	Communications are not stable due to external noise.	Separate the communications cables from power lines and perform other noise countermeasures.
	There are too many objects.	Decrease the number of objects on the screens for which refreshing is slow.
	There is a heavy processing load on the connected device that is resulting in extended cycle times.	Reduce the cycle time of the connected device.
	The message communications interval is too long.	Shorten the refreshing interval of the variable that is allocated to the object.
Gauges are refreshed too slowly.	Too many objects overlap the gauges.	<p>If multiple images are stacked behind the gauges, put them together in a single image.</p> <p>Lay out the gauges so that they do not overlap with other objects.</p>
Some of the objects on the screen are not displayed.	The <i>IsVisible</i> Check Box is not selected in the object settings.	Select the <i>IsVisible</i> Check Box in the object properties on the Sysmac Studio.
		If you change the <i>IsVisible</i> property, e.g., from a subroutine, set it to True.
The trend graph display does not match the actual log timing.	The communications address that is set as the event for the log timing is turning ON and OFF at a high speed.	Increase the ON/OFF interval for the communications address used as the event.
Numeric values cannot be input.	The upper/lower limit check for numeric inputs is operating.	Check the Minimum Value and Maximum Value properties of the object on the Sysmac Studio and correct them as required.
When an object is touched, nothing is input or executed.	A communications error occurred.	Check the connection between the NA Unit and connected device.
	The <i>IsEnabled</i> Check Box is not selected in the object settings.	<p>Select the <i>IsEnabled</i> Check Box in the object properties on the Sysmac Studio.</p> <p>If you change the <i>IsEnabled</i> property, e.g., from a subroutine, set it to True.</p>
	Security is set.	Log in at a level where the operation is allowed.
Operation is not possible for all objects.	The NA Unit is in Input Prohibited Mode.	Use the <i>EnableInputOperation</i> function or <i>EnableInputOperation</i> action to enable the inputs that are currently prohibited.
		Log in at a level where input is allowed.
The NA Unit will not change to the System Menu.	The currently logged in user does not have permission.	Go to the System Menu and log in as a level that has permission to display the System Menu.

● Errors Determined with Messages

Output message	Cause	Correction
E_COM_100, E_COM_101, E_COM_102, or E_COM_103: Failed to read the data (XXX).	The NA Unit cannot normally communicate with the connected device XXX, or the project information on the connected device XXX has been updated.	<ul style="list-style-type: none"> • Confirm that power is turned ON to the connected devices and network devices. • Confirm that the NA Unit, connected devices, and network devices are connected correctly. • Check the communications settings between the NA Unit and connected device. • Confirm that the tag settings for the NA Unit and for the connected device are correct, and verify the tags again.
E_COM_200, E_COM_201, E_COM_202, or E_COM_203: Failed to write the data (XXX).		
E_COM_001: Failed to connect to XXX - XXX (XXX).		
E_COM_002: Tag comparison error with xxx.	The tag specified for the project and the tag for the connected device XXX do not match.	Confirm that the tag settings for the NA Unit and for the connected device are correct, and verify the tags again.
E_SYS_002: XXX XXX is low on available free space	There is not sufficient space available on the SD Memory Card or in the USB Memory Device.	Replace the SD Memory Card or USB Memory Device with one with sufficient available space.
E_SYS_003: XXX XXX is very low on available free space		
E_SYS_004: Storage media XXX not found. Check if the storage media is inserted.	The specified SD Memory Card or USB Memory Device is not inserted in the NA Unit.	Insert an SD Memory Card or USB Memory Device into the NA Unit.
E_LOG_001: Backup to MRAM has failed for XXX	The M-RAM cannot be written normally.	Restart the NA Unit. If the same message is displayed after the restart, execute system recovery. If the same message is displayed even after system recovery, the NA Unit must be repaired. Inquire at the contact given on the back of this manual.
E_LOG_002: Failed to recover data from MRAM for XXX. All the data within MRAM have been cleared.	The XXX data on the M-RAM is in an illegal state.	
E_LOG_003: Failed to backup Alarms to MRAM.	The M-RAM cannot be written normally.	
E_LOG_004: Failed to recover Alarms from MRAM. All the data within MRAM have been cleared.	The alarm data on the M-RAM is in an illegal state.	
E_LOG_005: Failed to write XXX records to file: XXX	Logging the data failed.	<ul style="list-style-type: none"> • Insert an SD Memory Card or USB Memory Device into the NA Unit. • Replace the SD Memory Card or USB Memory Device with one with sufficient available space. If the same message is displayed even if you perform the above corrections, try replacing the SD Memory Card or USB Memory Device.
E_LOG_007: Failed to create log file for XXX		

Output message	Cause	Correction
E_LOG_006: Logging for XXX has been stopped	Initialization for data logging failed.	Restart the NA Unit. If the same message is displayed after the restart, execute system recovery. If the same message is displayed even after system recovery, the NA Unit must be repaired. Inquire at the contact given on the back of this manual.
E_MED_001: The format of the video file XXX used in XXX is not supported.	The video file has an unsupported format or is in an illegal state.	Convert the file to a supported format and download the data again.
E_MED_003: Failed to play the video (0XXXXXXXXXX).		
E_MED_004: Failed to pause the video (0XXXXXXXXXX).		
E_MED_005: Failed to stop the video (0XXXXXXXXXX).		
E_MED_006: Unexpected error in media player XXX.		
E_MED_007: Failed to initialise the media player. Check if the video file exists and its format is supported.		
E_RCP_001: Failed to import Recipe csv file XXX. Ingredients do not match template XXX.		
E_SYS_999: Runtime Exception Caught XXX	Illegal processing was performed.	Restart the NA Unit.
E_SEC_001: Invalid User XXX or password.	An unregistered user attempted to log in.	Log in as a registered user.
E_SEC_002: Detected permission that is invalid for User XXX under the current HMI settings.	The user attempted to use an object for which the user does not have permission.	Log in as a user that has permission set for the object.
E_SEC_003: Login blocked for XXX minutes.	Incorrect passwords were consecutively entered too many times.	Wait for the displayed length of time and then try to log in again.
E_PAG_007: Error occurred while evaluating expression for action XXX of object XXX on page XXX.	An invalid expression is set for the expression for an object.	Please check the syntax to set for expressions.

● Error Codes Correspondence Table

The displayed error codes depend on the runtime version. A correspondence table is given below:

Error codes prior to runtime version 1.03	Error codes for runtime version 1.03 or higher
ManE202	E_COM_100, E_COM_101, E_COM_102, or E_COM_103
ManE203	E_COM_200, E_COM_201, E_COM_202, or E_COM_203
ManE204	E_COM_001
ManW301	E_SYS_002
ManW302	E_SYS_003
ManE303	E_SYS_004
ManE304	E_LOG_001
ManE305	E_LOG_002
ManE306	E_LOG_003
ManE307	E_LOG_004
ManE308	E_LOG_005
ManE310	E_LOG_007
ManE309	E_LOG_006
ManE401	E_MED_001
ManE403	E_MED_003
ManE404	E_MED_004
ManE405	E_MED_005
ManE408	E_MED_006
ManE409	E_MED_007
ManE501	E_RCP_001
ManE901	E_SYS_999
ManE101	E_SEC_001
ManE103	E_SEC_002
ManE104	E_SEC_003

6

Maintenance

This section describes the required inspections and maintenance. It also describes the service life and replacement procedure for the Battery.

6-1	Periodic Maintenance and Inspection	6-2
6-1-2	Periodic Inspection	6-2
6-1-3	Precautions When Replacing the NA Unit	6-4
6-1-4	Cleaning	6-4
6-2	Replacing the Battery	6-5
6-2-1	Battery Replacement	6-5
6-2-2	Operation without a Battery	6-6

6-1 Periodic Maintenance and Inspection

Periodic inspections are required in order to maintain the NA-series PT in the best operating condition.

6-1-1 Preparations for Problems

Observe the following precautions to enable smooth troubleshooting when problems occur.

- **Backing Up the Sysmac Studio Project**

Always make a backup of the Sysmac Studio project and store it in a safe place. You will need it if you have to send in the NA Unit for repairs or if replace the NA Unit with another NA Unit.

- **Spare NA Units**

We recommend that you keep spare NA Units on hand to enable faster system recovery when problems occur with an NA Unit, the backlight reaches the end of its life making the display hard to see, etc.

6-1-2 Periodic Inspection

Although the major components in NA Unit have an extremely long life time, they can deteriorate under improper environmental conditions. Periodic inspections are thus required.

Inspection is recommended at least once every six months to a year, but more frequent inspections will be necessary according to the ambient environment.

Take immediate steps to correct the situation if any of the conditions in the following table are outside of the criteria.

Periodic Inspection Points

No.	Item	Inspection	Criteria	Correction
1	Source power supply	Check for voltage fluctuations at the power supply terminals.	The voltage must be within the allowable voltage fluctuation range (19.2 to 28.8 V (24 V \pm 20%)).	Use a voltage tester to check the power supply at the terminals. Take necessary steps to bring voltage fluctuations within limits.

No.	Item	Inspection	Criteria	Correction
2	Ambient environment	Make sure that the ambient temperature (e.g., the temperature inside the control panel) is suitable.	0 to 50°C ^{*1}	Use a thermometer to check the temperature and ensure that the ambient temperature remains within the allowable range.
		Make sure that the ambient humidity (e.g., the humidity inside the control panel) is suitable.	The relative humidity must be 10% to 90% with no condensation. ^{*1}	Use a hygrometer to check the humidity and ensure that the ambient humidity remains within the allowable range. Be careful of the condensation caused by temperature changes.
		Check that the NA Unit is not in direct sunlight.	Not in direct sunlight	Protect the NA Unit if necessary.
		Check for accumulation of dirt, dust, salt, metal powder, etc.	No accumulation	Clean and protect the NA Unit if necessary.
		Check for water, oil, or chemical sprays that may land on the NA Unit.	No spray	Clean and protect the NA Unit if necessary.
		Check for corrosive or flammable gases in the area of the NA Unit.	No corrosive or flammable gases	Check by smell or use a sensor.
		Check for direct vibration or shock placed on the NA Unit.	Vibration resistance and shock resistance must be within specifications.	Install cushioning or shock absorbing equipment if necessary.
3	Installation and wiring	Check the mounting brackets to see if they are loose.	No looseness	Tighten loose screws with a Phillips-head screwdriver.
		Check that cable connectors are fully inserted and locked.	No looseness	Fully insert and lock the connector
		Check for loose screws in external wiring.	No looseness	Tighten loose screws with a Phillips-head screwdriver.
		Check crimp connectors in external wiring.	Adequate spacing between connectors	Check visually and adjust if necessary.
		Check for damaged external wiring cables.	No visible damage	Check visually and replace cables if necessary.
4	User-serviceable parts	Check the brightness of the backlight.	The backlight must be sufficiently bright. Backlight life (at room temperature and humidity): 50,000 hours	Contact your OMRON representative to request replacement.
		Check whether the CJ1W-BAT01 Battery Set has reached its service life or whether it is passed the expiration date.	Service life expectancy is 5 years.	Replace the Battery when its service life expectancy has passed even if a Battery error has not occurred.
5	Touch panel position input accuracy	Are the touched positions and the positions that respond offset?	The positions must not be offset.	Calibrate the touch panel with the System Menu.

*1. The ambient temperature and ambient humidity criteria depend on conditions. Refer to 1-4-1 *General Specifications* on page 1-7.

Tools Required for Inspections

● Required Tools

- Phillips-head screwdriver
- Voltage tester or digital multi-meter
- Industrial alcohol and clean cotton cloth

● Tools Required Occasionally

- Thermometer and hygrometer (humidity meter)

6-1-3 Precautions When Replacing the NA Unit

If you discover a fault in the NA Unit during inspections and must replace the NA Unit, observe the following precautions when you replace the NA Unit.

- Back up the NA Unit data. If OMRON performs repairs, the data may be deleted.
- Do not replace the NA Unit until the power is turned OFF.
- Check the new NA Unit to make sure that there are no errors.
- If you return a faulty NA Unit for repair, describe the problem in as much detail as possible and enclose this description with the NA Unit.
- For poor contact, take a clean cotton cloth, soak the cloth in industrial alcohol, and carefully wipe the contacts clean. Be sure to remove any lint prior to remounting the NA Unit.



Precautions for Correct Use

If you replaced the NA Unit, transfer the project and the variables with a Retain attribute (i.e., variables retained during power interruptions) that are required at startup before you start operation. Unexpected accidents may occur depending on the relation between the project and the status of variables retained during power interruptions.

6-1-4 Cleaning

Clean the NA Unit periodically in order to keep it in the best operating condition.

● Cleaning Method

If the touch panel becomes dirty, the displays will be hard to see. Periodically clean the touch panel as follows:

- Wipe the NA Unit daily with a dry, soft cloth. If the touch panel is very dirty and you try to clean it with a dry cloth, you may scratch the front sheet. Use a damp cloth first to remove the dirt.
- When a spot cannot be removed with a dry cloth, dampen the cloth with a neutral cleanser (an approximately 2% solution), wring out the cloth, and wipe the NA Unit.
- A smudge may remain on the NA Unit from gum, vinyl, or tape that was left on for a long time. Remove any smudges when cleaning.



Precautions for Safe Use

Do not use volatile solvents such as benzene and thinners or chemical cloths.

6-2 Replacing the Battery

The Battery in the NA Unit requires maintenance. (The Battery is for the NA Unit's internal clock.) This section describes how to replace the Battery.

6-2-1 Battery Replacement

Purpose of the Battery

It is used to maintain the clock information in the NA Unit while the power supply is OFF. The clock will stop if there is no Battery or the Battery has been discharged completely.



Precautions for Correct Use

The Battery will lose its charge faster at high ambient temperatures.

Low Battery Indicators

When the Battery voltage drops below a certain level, the `_HMI_IsBatteryLow` (Low Battery Voltage) system-defined variable changes to True.

If the indicator flashes, connect the Sysmac Studio and see if the `_HMI_IsBatteryLow` system-defined variable in the Sysmac Studio is True. If it is True, first check the Battery connection in the NA Unit. If the Battery in the NA Unit is properly connected, replace the Battery with a new one as soon as possible.

Even if `_HMI_IsBatteryLow` changes to True, clock information can be retained by ensuring that the power supply to the NA Unit is not turned OFF.

Replacement Procedure

Use the following procedure to replace the Battery when the previous Battery has become completely discharged. Refer to *2-1-1 Components and Functions* on page 2-2 for the details on replacing Battery.



Precautions for Safe Use

- Do not touch the packaging part of the circuit board with your bare hands. Discharge any static electricity from your body before handling the board.
- Do not use any battery if strong impact is applied to it (e.g. by dropping on the floor) because such a battery may cause a leakage.
- Apply power for at least five minutes before changing the battery. Mount a new battery within five minutes after turning OFF the power supply. If power is not supplied for at least five minutes, the clock data may be lost. Check the clock data after changing the battery.
- Do not dismantle a battery nor let it short-circuit.
- Do not apply an impact with the lithium battery, charge it, dispose it into a fire, or heat it. Doing either of them may cause an ignition or a bursting.
- Turn ON the power after replacing the Battery for an NA Unit that has not been used for a long time. Leaving the NA Unit unused again without turning ON the power even once after the Battery is replaced may result in a shorter Battery life.
- The following is required by UL standards:
The Battery inside this product is not user replaceable. Replacement of the lithium battery needs to be done by a trained technician.

- 1 Turn OFF the power supply to the NA Unit.
If the NA Unit has not been ON, turn it ON for at least five minutes and then turn it OFF.
- 2 Open the cover on the NA Unit, disconnect the Battery connector, remove the Battery, and replace it with a new Battery.

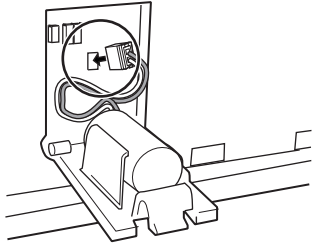

Precautions for Correct Use

Be sure to install a replacement Battery within two years of the production date shown on the Battery label.

Production Date



Manufactured in March 2014.



Additional Information

When you turn ON the power supply to the NA Unit after you replace the Battery, the `_HMI_IsBatteryLow` system-defined variable will automatically change to False.

6-2-2 Operation without a Battery

If a Battery is not connected or the Battery voltage is too low, the following operation occurs.

- The `_HMI_IsBatteryLow` system-defined variable will change to True.
- Clock information will be incorrect.

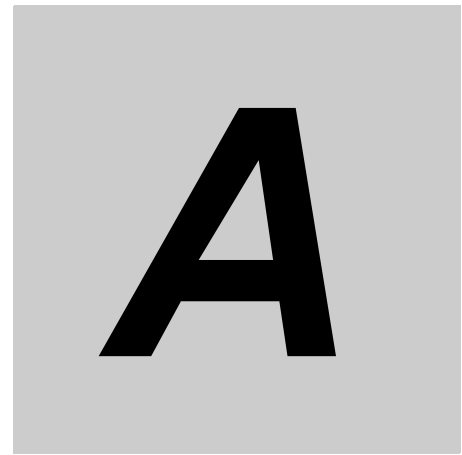

Appendices

The appendices provide specifications and other information not provided in the body of this manual.

A-1 Dimensions	A-2
A-1-1 NA Units	A-2
A-2 Available Products	A-6
A-2-1 Optional Products	A-6

A-1 Dimensions

A-1-1 NA Units

NA5-15W□□□□

- NA Units

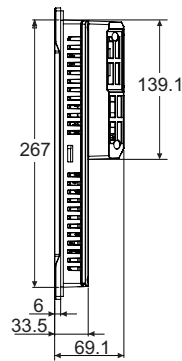
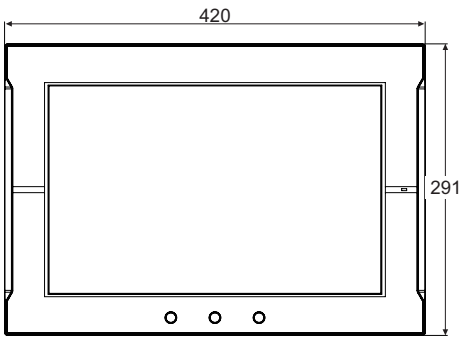
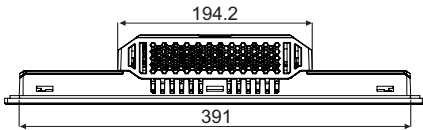

(Unit: mm)

- Cable Connection Dimensions

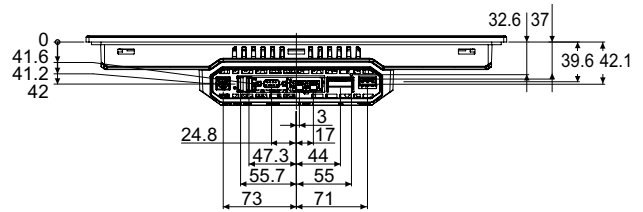
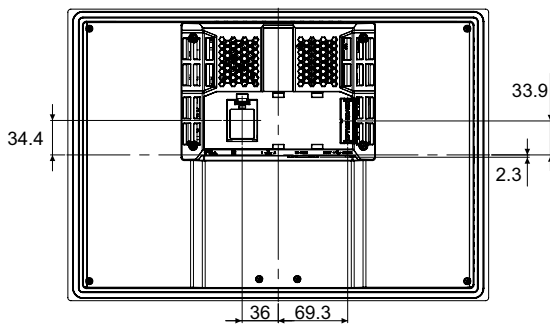

(Unit: mm)

NA5-12W□□□□

● NA Units

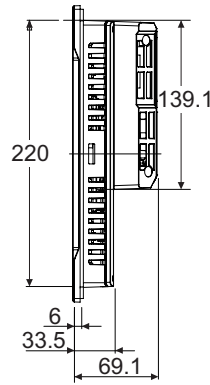
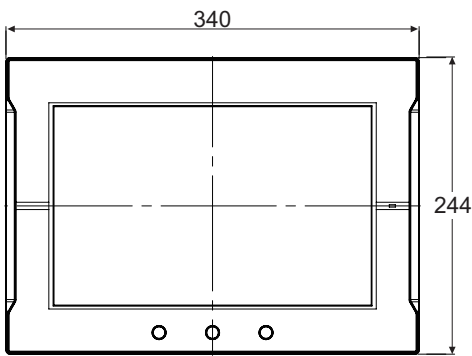
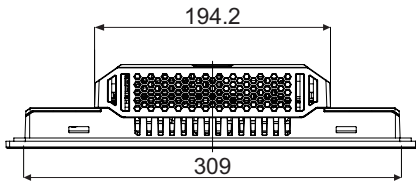

(Unit: mm)

● Cable Connection Dimensions

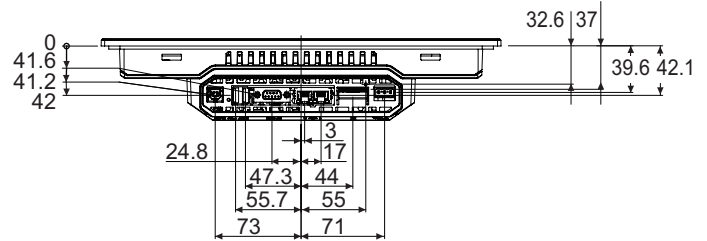
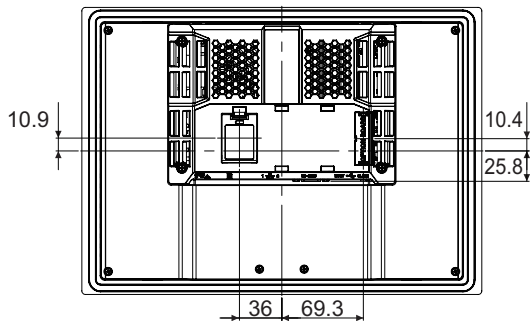

(Unit: mm)

NA5-9W□□□□

● NA Units

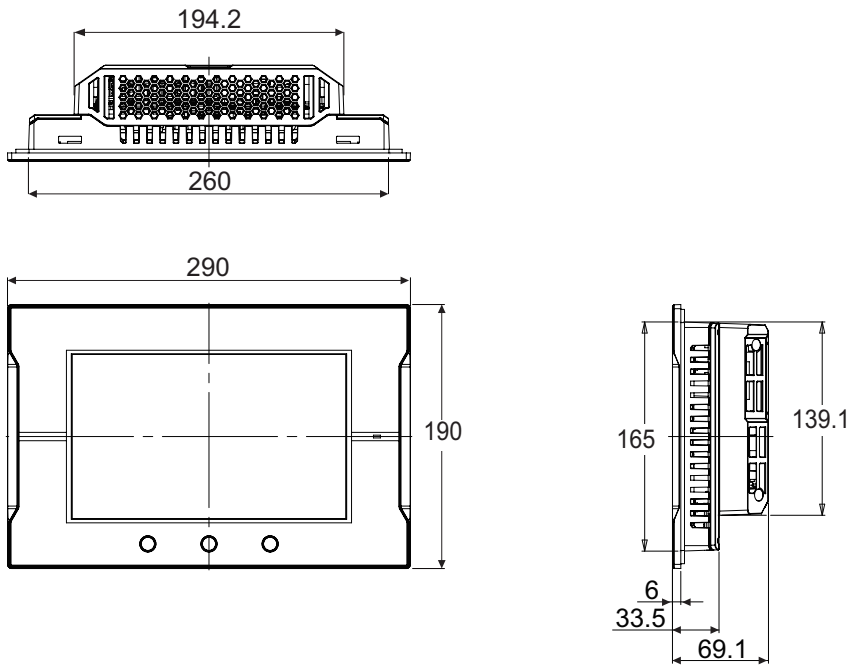

(Unit: mm)

● Cable Connection Dimensions

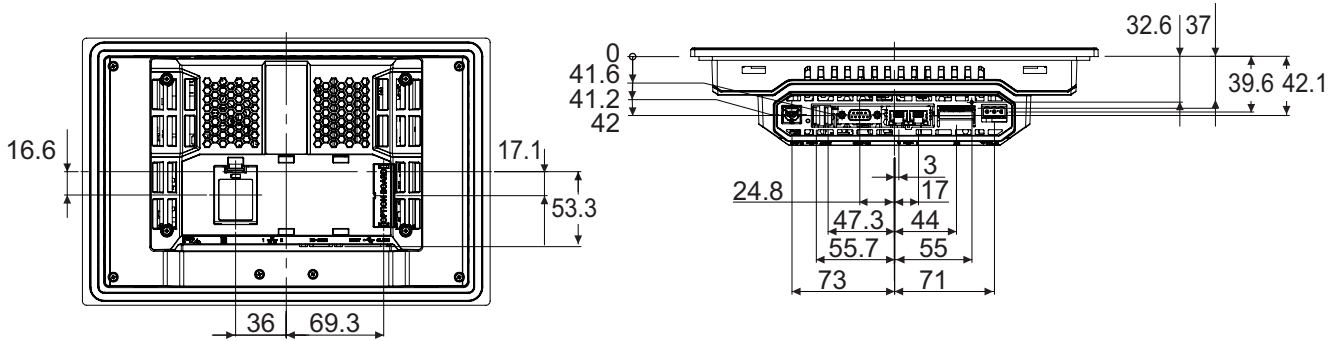

(Unit: mm)

NA5-7W□□□□

● NA Units

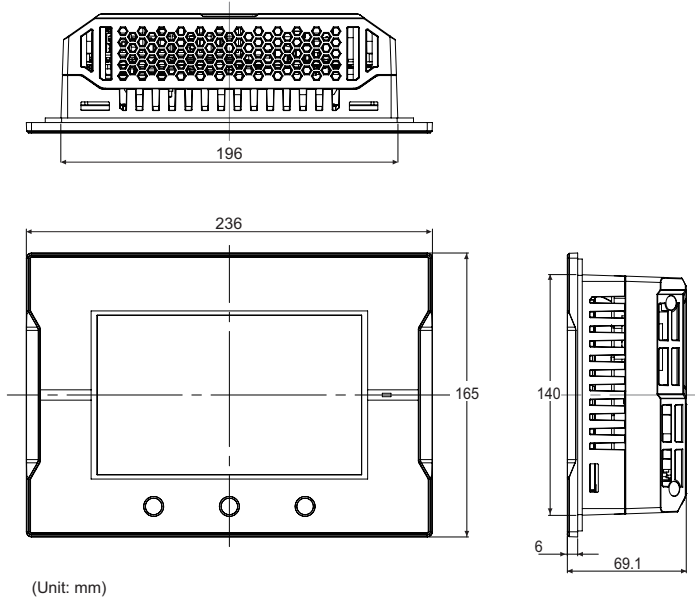

● Cable Connection Dimensions

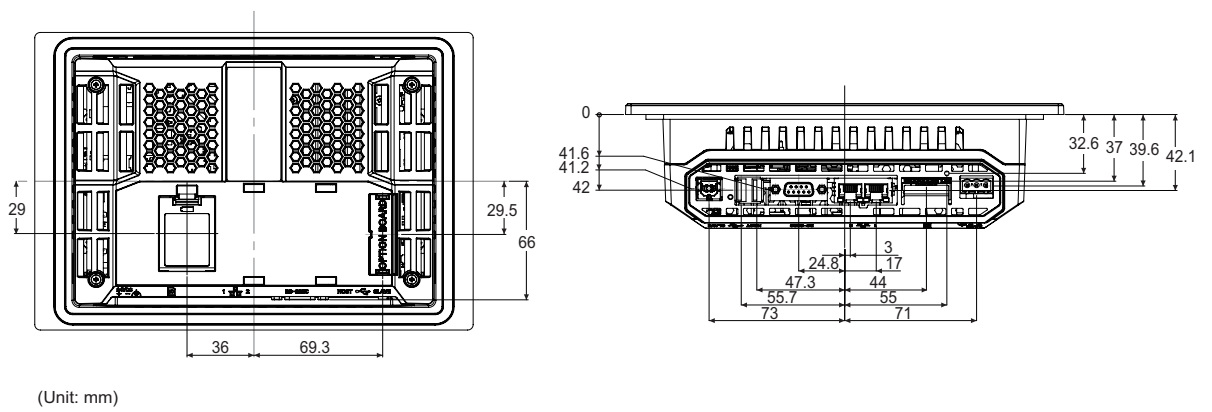

A-2 Available Products

A-2-1 Optional Products

Table of Optional Products

Name	Model	Remarks
Anti-reflection Sheets	NA-15WKBA04	Anti-reflection Sheets for NA5-15W□□□□
	NA-12WKBA04	Anti-reflection Sheets for NA5-12W□□□□
	NA-9WKBA04	Anti-reflection Sheets for NA5-9W□□□□
	NA-7WKBA04	Anti-reflection Sheets for NA5-7W□□□□
High-pressure Waterproof Attachment (PWA)	NA-15WATW01	High-pressure waterproofing frame for NA5-15W□□□□
	NA-12WATW01	High-pressure waterproofing frame for NA5-12W□□□□
	NA-9WATW01	High-pressure waterproofing frame for NA5-9W□□□□
	NA-7WATW01	High-pressure waterproofing frame for NA5-7W□□□□
Battery	CJ1W-BAT01	Replacement Battery
SD Memory Cards	HMC-SD291	SD Memory Card
	HMC-SD491	SD Memory Card
	FZ-MEM2G	USB Memory Device
	FZ-MEM8G	USB Memory Device

NA-□□WKBA04 Anti-reflection Sheets

Attach a Sheet to the screen to protect against diffused reflections and dirt. The entire Sheet is colorless and transparent. Five Sheets are provided in one set.

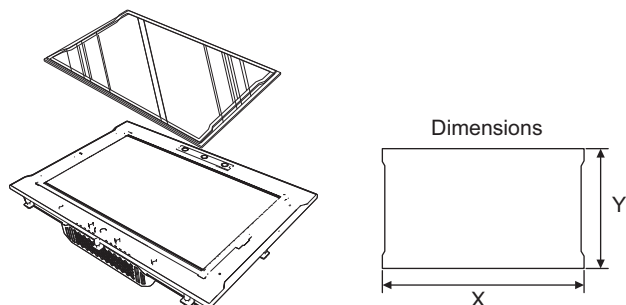

Material	Attachment method
Polyester film	Double-sided tape

Model	Specification	Dimensions (Unit: mm)	
		X	Y
NA-15WKBA04	Anti-reflective protective sheets for NA5-15W□□□□	415	286
NA-12WKBA04	Anti-reflective protective sheets for NA5-12W□□□□	335	239
NA-9WKBA04	Anti-reflective protective sheets for NA5-9W□□□□	285	185
NA-7WKBA04	Anti-reflective protective sheets for NA5-7W□□□□	231	160

NA-□□WATW01 High-pressure Waterproof Attachment

The High-pressure Waterproof Attachment (PWA) is required to conform to UL Type 4X standards. The mounting panel thickness must be between 1.6 and 4.5 mm. To conform to UL Type 4X standards, always use the NA5-□□W□□□□ with a High-pressure Waterproof Attachment (PWA). If you do not use a PWA, there is a risk of water entry, which may cause severe equipment damage.

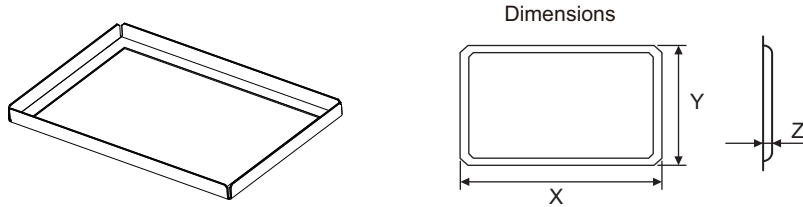

Material	Attachment method
Stainless steel (AISI 304)	Mounting brackets

Model	Specification	Dimensions (Unit: mm)		
		X	Y	Z
NA-15WATW01	High-pressure Waterproof Attachment for NA5-15W□□□□	430	306	19
NA-12WATW01	High-pressure Waterproof Attachment for NA5-12W□□□□	348	259	19
NA-9WATW01	High-pressure Waterproof Attachment for NA5-9W□□□□	298	203	19
NA-7WATW01	High-pressure Waterproof Attachment for NA5-7W□□□□	234	178	19

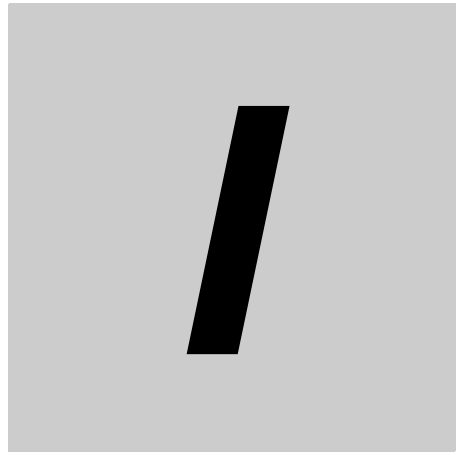

Index



A		N	
ABS	1-21	NA-series Programmable Terminals	1-2
Anti-reflection Sheets	1-6	NK	1-21
available products	1-5, A-6	P	
B		performance specifications	1-10
Battery	1-6	periodic inspection	6-2
battery replacement	6-5	power supply connector	2-6
BV	1-21	power supply specifications	3-9
C		R	
cleaning	6-4	RCM	1-8
control panel	3-4	reset switch	2-6
CR	1-21	RINA	1-21
D		RUN indicator	2-2, 5-2
data capacity	1-10	S	
dimensions	A-2	SD Memory Card slot	1-11
DNV	1-21	SD Memory Cards	1-6, 2-9
E		Serial port	1-11
EMC Directive	1-8	shipbuilding standards	1-21
errors	5-2, 5-3	support software	1-5, 2-13
Ethernet ports	1-11, 2-6	system configurations	1-4
Expansion Unit connector	1-11	System Menu	4-6
external interfaces	1-11	system program	4-2
F		system recovery	4-3
Function keys	2-2	T	
G		troubleshooting	5-4
general specifications	1-7	U	
GL	1-21	UL	1-8
grounding	3-12, 3-19	USB host ports	1-11
I		USB Memory Devices	1-6, 2-11
ID information label	2-8	USB slave port	1-11
installing NA Units	3-4	W	
K		wiring methods	3-9
KC Standards	1-8		
KR	1-21		
L			
LR	1-21		

OMRON AUTOMATION AND SAFETY • THE AMERICAS HEADQUARTERS • Chicago, IL USA • 847.843.7900 • 800.556.6766 • www.omron247.com

OMRON CANADA, INC. • HEAD OFFICE

Toronto, ON, Canada • 416.286.6465 • 866.986.6766 • www.omron247.com

OMRON ELECTRONICS DE MEXICO • HEAD OFFICE

México DF • 52.55.59.01.43.00 • 01-800-226-6766 • mela@omron.com

OMRON ELECTRONICS DE MEXICO • SALES OFFICE

Apodaca, N.L. • 52.81.11.56.99.20 • 01-800-226-6766 • mela@omron.com

OMRON ELETRÔNICA DO BRASIL LTDA • HEAD OFFICE

São Paulo, SP, Brasil • 55.11.2101.6300 • www.omron.com.br

OMRON ARGENTINA • SALES OFFICE

Cono Sur • 54.11.4783.5300

OMRON CHILE • SALES OFFICE

Santiago • 56.9.9917.3920

OTHER OMRON LATIN AMERICA SALES

54.11.4783.5300

OMRON EUROPE B.V. • Wegalaan 67-69, NL-2132 JD, Hoofddorp, The Netherlands. • +31 (0) 23 568 13 00 • www.industrial.omron.eu

Authorized Distributor:

Automation Control Systems

- Machine Automation Controllers (MAC) • Programmable Controllers (PLC)
- Operator interfaces (HMI) • Distributed I/O • Software

Drives & Motion Controls

- Servo & AC Drives • Motion Controllers & Encoders

Temperature & Process Controllers

- Single and Multi-loop Controllers

Sensors & Vision

- Proximity Sensors • Photoelectric Sensors • Fiber-Optic Sensors
- Amplified Photomicrosensors • Measurement Sensors
- Ultrasonic Sensors • Vision Sensors

Industrial Components

- RFID/Code Readers • Relays • Pushbuttons & Indicators
- Limit and Basic Switches • Timers • Counters • Metering Devices
- Power Supplies

Safety

- Laser Scanners • Safety Mats • Edges and Bumpers • Programmable Safety Controllers • Light Curtains • Safety Relays • Safety Interlock Switches