

# **ELIMINATOR HD™**

## **Heavy Duty Ball Screw Linear Actuators**



- **Thrust From 2,000 to 25,000 lb<sub>f</sub>**
- **Heavy Wall Steel Construction**
- **Longest Life**
- **Simultaneous High Thrust with High Speed**
- **Piston with Rugged Anti Rotation Feature**
- **Sealed Chamber Design**

**EDRIVE™** Precision Mechanical Products  
A C T U A T O R S

## ELIMINATOR HD™ Heavy Duty Linear Actuator Features:

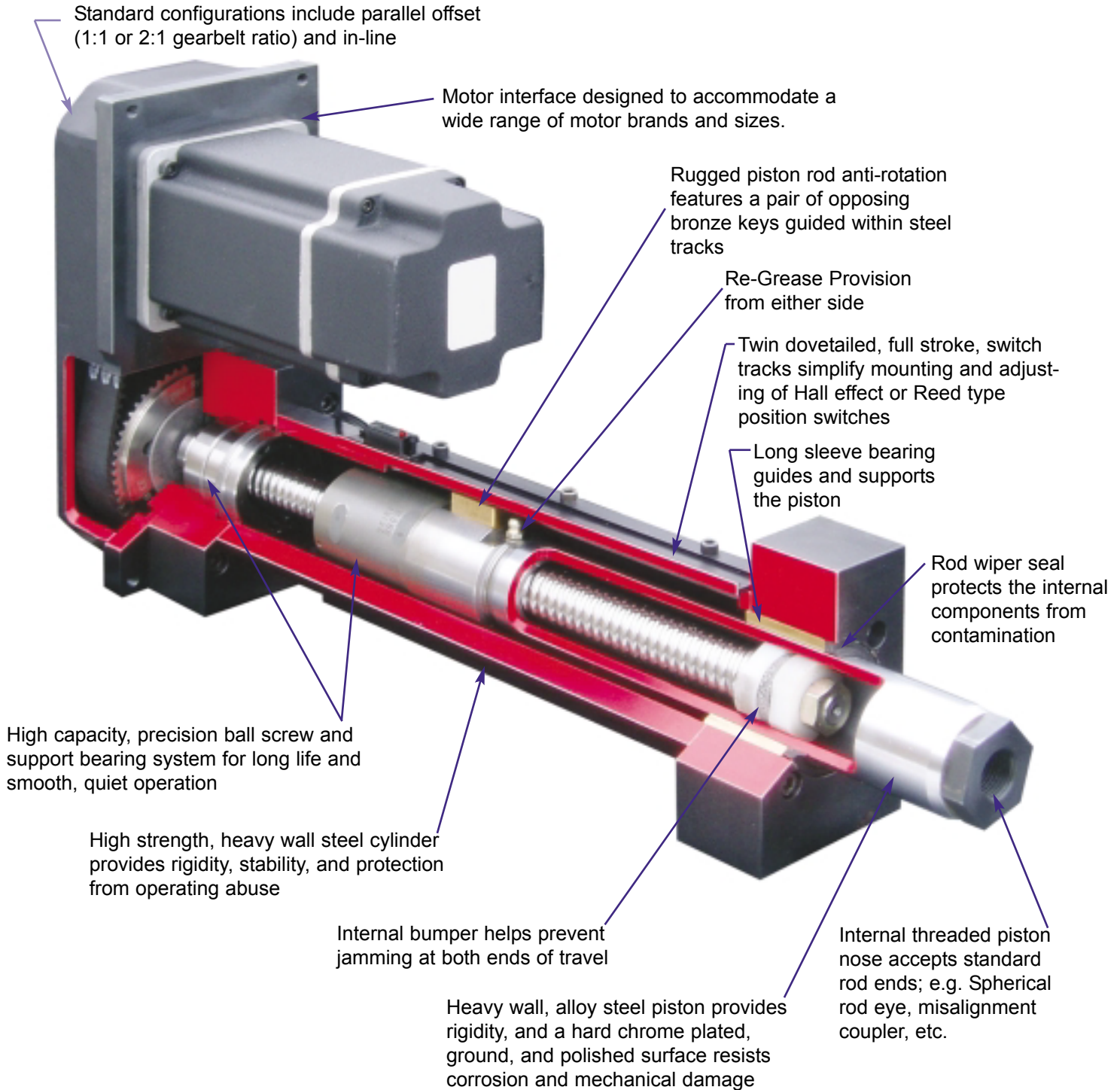

The **ELIMINATOR HD™** Heavy Duty ball screw linear actuator series was developed to provide a strong, durable, and precise ball screw linear actuator for high end applications. As an alternative to hydraulic actuators, it eliminates many of the associated concerns, such as noise, heat, leakage, controllability, and low stiffness, while handling high loads at high speeds and maintaining the rugged and durable steel construction typical of hydraulics.

**E** Drive Actuators, Inc. has shown consistent success in the toughest applications, e.g. High loads, high speeds, high precision, and extreme durability. Precision ball screw systems, tailored for maximum life, load and speed, provide the motion while fully enclosed, thus

eliminating contamination related failures. A long bronze nose bearing provides support for the extended piston. Rugged bronze keys in opposing steel slots provide anti-rotation and

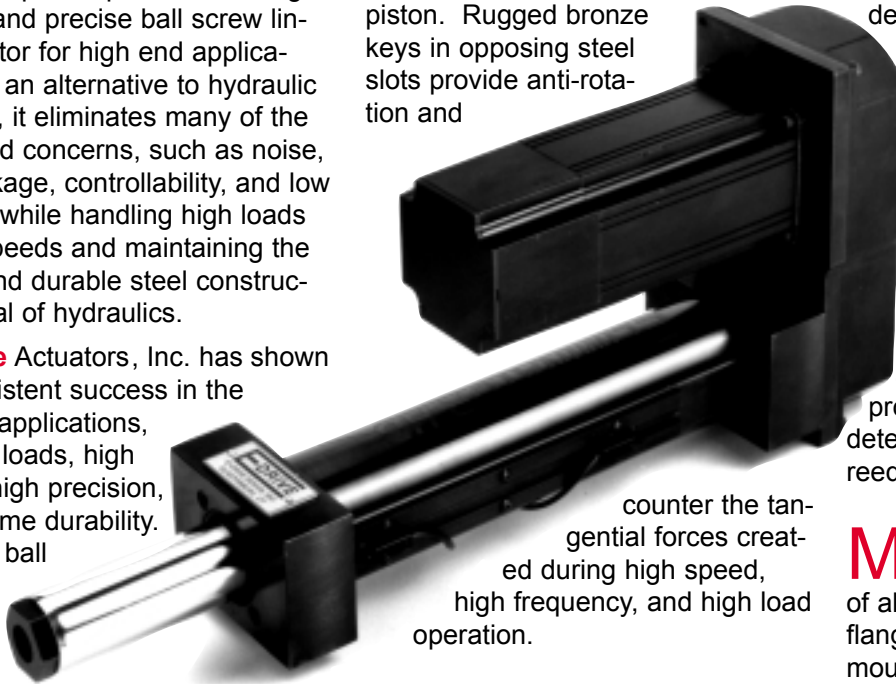

counter the tangential forces created during high speed, high frequency, and high load operation.

While other actuator designs force a particular motor decision, the **ELIMINATOR HD™** is designed to suit virtually any motor, gear box, or gearhead the customer chooses to use. In-line as well as parallel offset configurations are standard with 1:1 and 2:1 synchronous gearbelt ratios available.

**D**ual, nonferrous dovetail switch tracks provide a simple method of placing and adjusting switches for over travel protection as well as "home" detection. Hall effect type as well as reed limit switches are available.

**M**achine tool principals and guidelines ensure robust sizing of all components. Traditional front flange, bottom, foot, and trunion mounting capabilities are available for the standard price.

## **ELIMINATOR HD™** Heavy Duty Linear Actuator Benefits:

- **RUGGED STEEL CONSTRUCTION:** Tolerates rough operating conditions
- **HIGH DYNAMIC CAPACITY COMPONENTS:** Longest Life
- **HIGH THRUST EVEN AT HIGH SPEED:** Means no compromises in the production cycle
- **POSITIONAL ACCURACY:** Repeatable to .0005 inch
- **ACCEPTS MOST COMBINATIONS OF MOTORS OR GEARHEADS WITHOUT AN ADAPTER PLATE:** Reducing cost and allowing the end user to select their preferred motor source
- **IP54 RATED:** When using positive pressure purge provision
- **VARIETY OF STANDARD MOUNTING OPTIONS:** Makes it easy to mount and align actuator





## ELIMINATOR HD™ Capabilities

Model Number	Thrust Load Rated (lb <sub>f</sub> )	Thrust Load Max. (lb <sub>f</sub> )	Linear Velocity Max. (in/s)	Travel Length <sup>(1)</sup> Max. (in)	Frame Size (in)	Lead <sup>(2)</sup> (mm)	Ball Screw Diameter (mm)	Ball Screw Speed Max. (RPM)	Torque @ Ball Screw Max. (in-lb)	Dynamic Capacity per million revs (lb <sub>f</sub> )	Dynamic Capacity per million inches (lb <sub>f</sub> )	Motor/ <sup>(3)</sup> Gearhead Frame Supported Max. (in)	Unit Weight "U" Motor Mount (lb)	Unit Weight "L" Motor Mount (lb)
HD302-06	2,000	4,000	23.0	6	3	10	25	3,500	140	6,490	4,760	4.25	37	30
HD302-12	2,000	4,000	23.0	12	3	10	25	3,500	140	6,490	4,760	4.25	45	38
HD302-18	2,000	4,000	23.0	18	3	10	25	3,500	140	6,490	4,760	4.25	53	46
HD302-24	2,000	4,000	23.0	24	3	10	25	3,500	140	6,490	4,760	4.25	61	54
HD302-30	2,000	4,000	23.0	30	3	10	25	3,500	140	6,490	4,760	4.25	69	62
HD302-36	2,000	4,000	20.3	36	3	10	25	3,100	140	6,490	4,760	4.25	77	70
HD304-06	4,000	8,000	23.0	6	3	10	25	3,500	278	6,490	4,760	4.25	37	30
HD304-12	4,000	8,000	23.0	12	3	10	25	3,500	278	6,490	4,760	4.25	45	38
HD304-18	4,000	8,000	23.0	18	3	10	25	3,500	278	6,490	4,760	4.25	53	46
HD304-24	4,000	8,000	23.0	24	3	10	25	3,500	278	6,490	4,760	4.25	61	54
HD304-30	4,000	8,000	23.0	30	3	10	25	3,500	278	6,490	4,760	4.25	69	62
HD304-36	4,000	8,000	20.3	36	3	10	25	3,100	278	6,490	4,760	4.25	77	70
HD404-06	4,000	8,000	18.0	6	4	10	32	2,750	278	14,580	10,690	5.75	76	62
HD404-12	4,000	8,000	18.0	12	4	10	32	2,750	278	14,580	10,690	5.75	89	75
HD404-18	4,000	8,000	18.0	18	4	10	32	2,750	278	14,580	10,690	5.75	103	89
HD404-24	4,000	8,000	18.0	24	4	10	32	2,750	278	14,580	10,690	5.75	116	102
HD404-30	4,000	8,000	18.0	30	4	10	32	2,750	278	14,580	10,690	5.75	130	116
HD404-36	4,000	8,000	18.0	36	4	10	32	2,750	278	14,580	10,690	5.75	143	129
HD404-42	4,000	8,000	18.0	42	4	10	32	2,750	278	14,580	10,690	5.75	157	143
HD406-06	6,000	12,000	18.0	6	4	10	32	2,750	417	14,580	10,690	5.75	76	62
HD406-12	6,000	12,000	18.0	12	4	10	32	2,750	417	14,580	10,690	5.75	89	75
HD406-18	6,000	12,000	18.0	18	4	10	32	2,750	417	14,580	10,690	5.75	103	89
HD406-24	6,000	12,000	18.0	24	4	10	32	2,750	417	14,580	10,690	5.75	116	102
HD406-30	6,000	12,000	18.0	30	4	10	32	2,750	417	14,580	10,690	5.75	130	116
HD406-36	6,000	12,000	18.0	36	4	10	32	2,750	417	14,580	10,690	5.75	143	129
HD406-42	6,000	12,000	18.0	42	4	10	32	2,750	417	14,580	10,690	5.75	157	143
HD508-06	8,000	15,000	14.0	6	5	12	50	1,780	668	31,250	24,340	8	175	125
HD508-12	8,000	15,000	14.0	12	5	12	50	1,780	668	31,250	24,340	8	195	145
HD508-18	8,000	15,000	14.0	18	5	12	50	1,780	668	31,250	24,340	8	216	166
HD508-24	8,000	15,000	14.0	24	5	12	50	1,780	668	31,250	24,340	8	236	186
HD508-30	8,000	15,000	14.0	30	5	12	50	1,780	668	31,250	24,340	8	257	207
HD508-36	8,000	15,000	14.0	36	5	12	50	1,780	668	31,250	24,340	8	277	227
HD508-42	8,000	15,000	14.0	42	5	12	50	1,780	668	31,250	24,340	8	298	248
HD508-48	8,000	15,000	14.0	48	5	12	50	1,780	668	31,250	24,340	8	318	268
HD516-06	16,000	30,000	14.0	6	5	12	50	1,780	1,337	31,250	24,340	8	175	125
HD516-12	16,000	30,000	14.0	12	5	12	50	1,780	1,337	31,250	24,340	8	195	145
HD516-18	16,000	30,000	14.0	18	5	12	50	1,780	1,337	31,250	24,340	8	216	166
HD516-24	16,000	30,000	14.0	24	5	12	50	1,780	1,337	31,250	24,340	8	236	186
HD516-30	16,000	30,000	14.0	30	5	12	50	1,780	1,337	31,250	24,340	8	257	207
HD516-36	16,000	30,000	14.0	36	5	12	50	1,780	1,337	31,250	24,340	8	277	227
HD516-42	16,000	30,000	14.0	42	5	12	50	1,780	1,337	31,250	24,340	8	298	248
HD516-48	16,000	30,000	14.0	48	5	12	50	1,780	1,337	31,250	24,340	8	318	268
HD618-06	18,000	30,000	9.8	6	6	12	63	1,450	1,500	35,750	27,840	8	240	185
HD618-12	18,000	30,000	9.8	12	6	12	63	1,450	1,500	35,750	27,840	8	273	218
HD618-18	18,000	30,000	9.8	18	6	12	63	1,450	1,500	35,750	27,840	8	306	251
HD618-24	18,000	30,000	9.8	24	6	12	63	1,450	1,500	35,750	27,840	8	339	284
HD618-30	18,000	30,000	9.8	30	6	12	63	1,450	1,500	35,750	27,840	8	372	317
HD618-36	18,000	30,000	9.8	36	6	12	63	1,450	1,500	35,750	27,840	8	405	350
HD618-42	18,000	30,000	9.8	42	6	12	63	1,450	1,500	35,750	27,840	8	438	383
HD618-48	18,000	30,000	9.8	48	6	12	63	1,450	1,500	35,750	27,840	8	471	416
HD625-06	25,000	40,000	14.4	6	6	20	80	1,100	3,481	52,150	48,160	8	247	191
HD625-12	25,000	40,000	14.4	12	6	20	80	1,100	3,481	52,150	48,160	8	280	224
HD625-18	25,000	40,000	14.4	18	6	20	80	1,100	3,481	52,150	48,160	8	313	257
HD625-24	25,000	40,000	14.4	24	6	20	80	1,100	3,481	52,150	48,160	8	346	290
HD625-30	25,000	40,000	14.4	30	6	20	80	1,100	3,481	52,150	48,160	8	379	323
HD625-36	25,000	40,000	14.4	36	6	20	80	1,100	3,481	52,150	48,160	8	412	356
HD625-42	25,000	40,000	14.4	42	6	20	80	1,100	3,481	52,150	48,160	8	445	389
HD625-48	25,000	40,000	14.4	48	6	20	80	1,100	3,481	52,150	48,160	8	478	422

(1) Intermediate lengths are available; Longer lengths possible.

(2) Standard lead accuracy is .002 in/ft; Optional lead accuracy is .0005 in/ft.

Standard backlash is .003 in maximum; Optional zero backlash is also available.

(3) Motor adapter plates are available for larger motor frames.

### Graph 1: Life Vs. Load

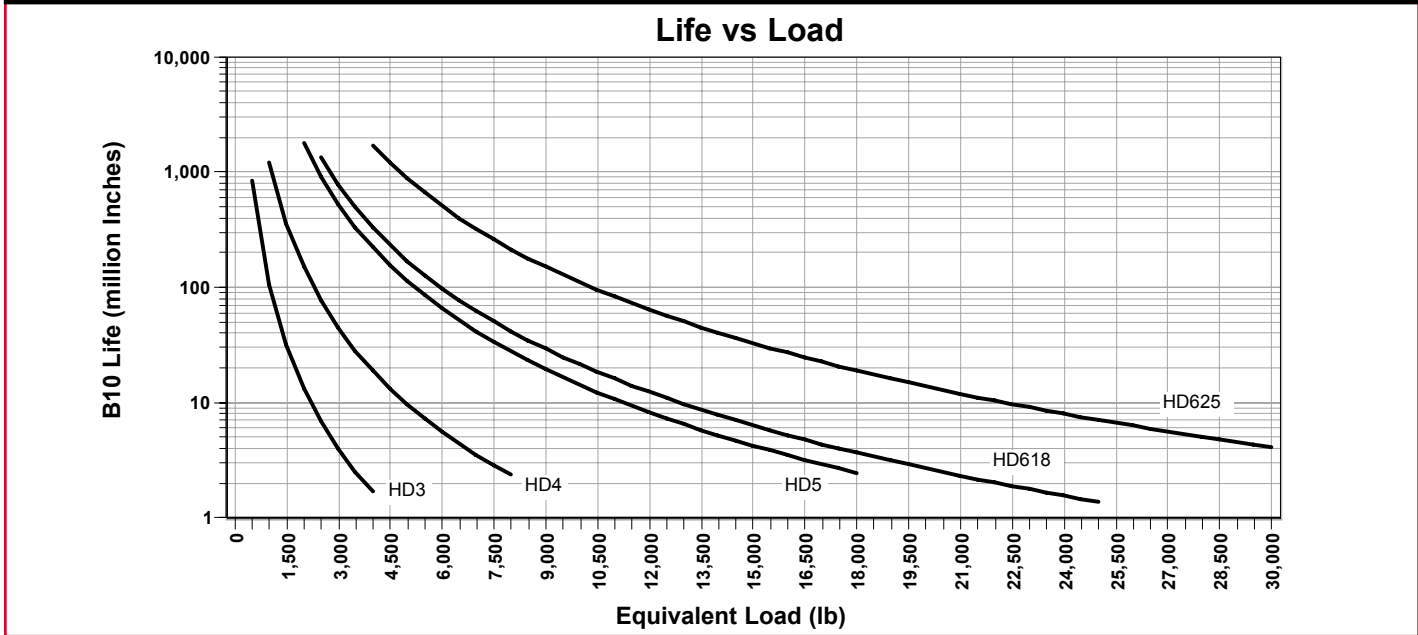

**EQUIVALENT LOAD** is the average force over the working stroke, weighted proportionately to the distance traveled. For constant force loads, the equivalent load is the same as the typical or average load. Where forces vary due to gravity, angle of actuator, acceleration and deceleration, friction, and changing dynamic loads at different positions, it is best to determine the equivalent load in order to most accurately predict the B10 life of the actuator.

$$F = \sqrt[3]{\frac{L_1(F_1)^3 + L_2(F_2)^3 + L_3(F_3)^3 + L_4(F_4)^3 + \dots + L_n(F_n)^3}{L}}$$

Where:  $F_n$  is the calculated force for segment "n" with travel length of  $L_n$  and total travel  $L$ .

Find the intersection of this value and the appropriate curve. The value on the scale to the left reflects the B10 life of the actuator.

### Graph 2: Torque Vs. Thrust at Ball Screw

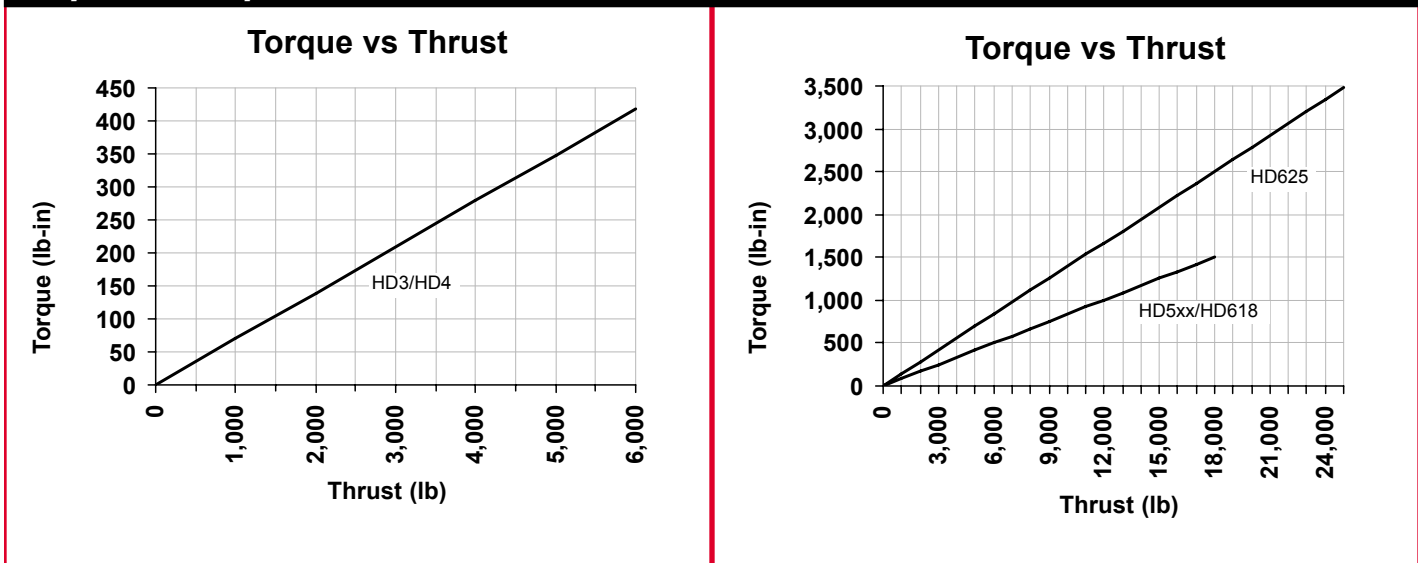

The approximate motor torque required to produce a given force can be determined by examining the appropriate chart above, finding the intersection between the thrust required and the line and following that to the vertical axis where you can get an approximate torque requirement. This is for a 1:1 gearbelt or in-line arrangement. For 2:1, the torque can be reduced by 50%.

## ELIMINATOR HD™ General Dimensions

### U-Parallel Offset Motor Configuration

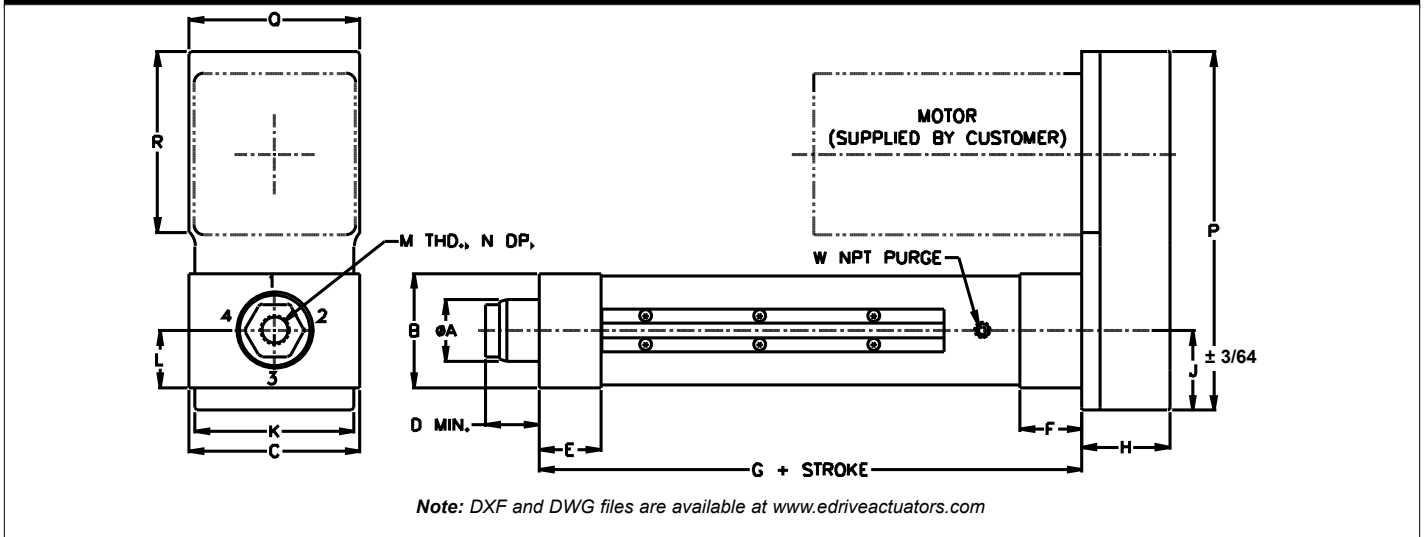

### L-Inline Motor Configuration

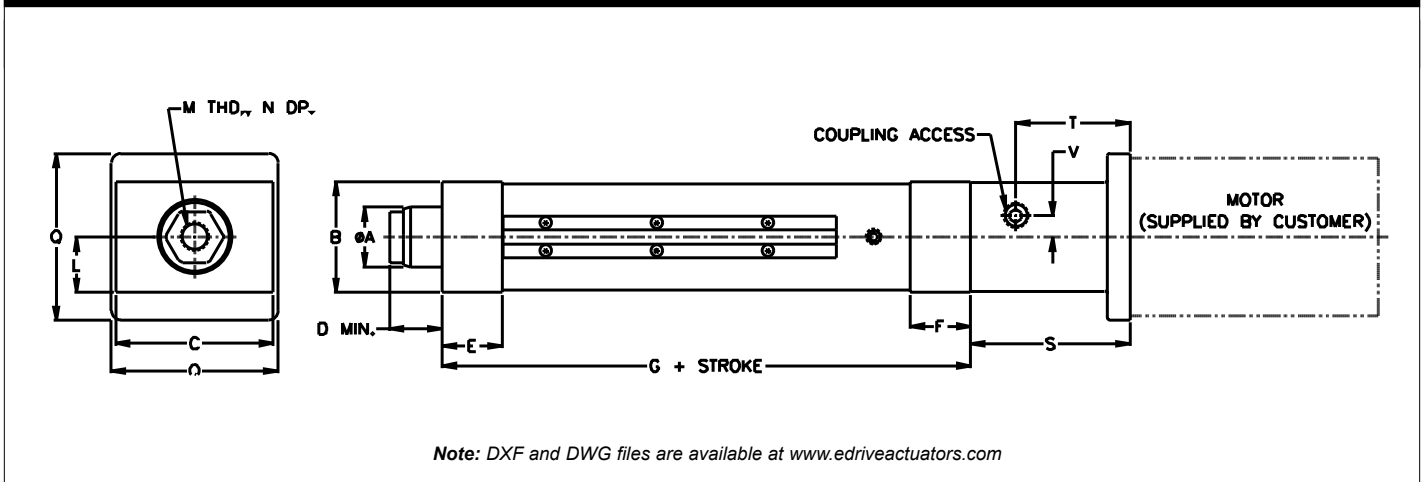

### ELIMINATOR HD™ U-Parallel Offset and L-Inline Motor Configuration

Model	A	B	C	D	E	F	G	H	J	K	L	M	N
HD302	1.63	3.00	4.25	1.41	1.63	1.63	8.28	2.34	2.09	4.19	1.50	3/4-16	1.00
HD304	1.63	3.00	4.25	1.56	1.63	1.63	8.28	2.34	2.09	4.19	1.50	3/4-16	1.00
HD404	2.25	4.00	5.50	1.88	2.00	2.00	9.59	2.63	2.69	5.38	2.00	3/4-16	1.00
HD406	2.25	4.00	5.50	1.79	2.00	2.00	9.59	2.63	2.69	5.38	2.00	3/4-16	1.00
HD508	3.00	5.00	7.75	2.56	2.50	3.00	13.38	4.03	3.81	7.63	2.50	1 1/4-12	1.63
HD516	3.00	5.00	7.75	2.56	2.50	3.00	13.38	4.03	3.81	7.63	2.50	1 1/4-12	1.63
HD618	3.50	6.00	8.50	2.75	3.00	3.00	14.00	4.13	4.13	8.38	3.00	1 1/4-12	1.63
HD625	4.00	6.00	8.50	2.75	3.00	3.00	16.75	4.13	4.13	8.38	3.00	1 1/4-12	1.63

Model	P	Q	R	S	T	V	W
HD302	9.44	4.50	4.75	4.31	3.09	0.58	1/8
HD304	9.44	4.50	4.75	4.31	3.09	0.58	1/8
HD404	13.00	6.00	6.94	5.00	3.94	0.81	1/4
HD406	13.00	6.00	6.94	5.00	3.94	0.81	1/4
HD508	17.19	8.38	9.19	6.75	4.63	1.00	3/8
HD516	17.19	8.38	9.19	6.75	4.63	1.00	3/8
HD618	17.88	9.00	9.19	7.25	5.13	1.19	1/2
HD625	17.88	9.00	9.19	7.25	5.13	1.19	1/2

### ELIMINATOR HD™ Bottom Mount Dimensions

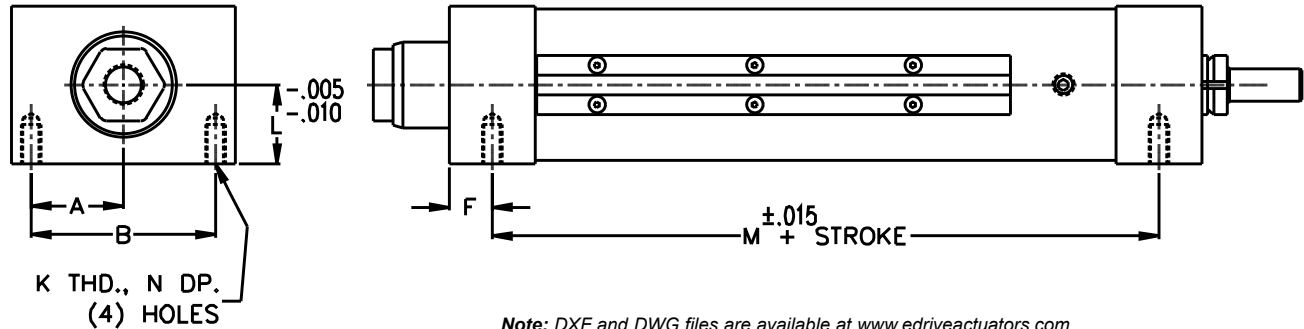

### ELIMINATOR HD™ Bottom Mount Dimensions

Model	A	B	C	D	E	F	G	H	J	K	L	M	N
HD302	1.75	3.50	1.13	2.25	0.41	0.81	3.38	6.75	1.00	3/8-16	1.50	6.66	0.75
HD304	1.75	3.50	1.13	2.25	0.41	0.81	3.38	6.75	1.00	3/8-16	1.50	6.66	0.75
HD404	2.19	4.38	1.44	2.88	0.69	1.00	4.50	9.00	1.25	5/8-11	2.00	7.59	1.00
HD406	2.19	4.38	1.44	2.88	0.69	1.00	4.50	9.00	1.25	5/8-11	2.00	7.59	1.00
HD508	3.13	6.25	1.75	3.50	0.81	1.25	6.25	12.50	1.50	3/4-10	2.50	10.63	1.25
HD516	3.13	6.25	1.75	3.50	0.81	1.25	6.25	12.50	1.50	3/4-10	2.50	10.63	1.25
HD618	3.31	6.63	2.00	4.00	1.06	1.50	7.13	14.25	2.00	1-8	3.00	11.00	1.63
HD625	3.31	6.63	2.00	4.00	1.06	1.50	7.13	14.25	2.00	1-8	3.00	13.75	1.63

### ELIMINATOR HD™ Front Flange Mount Dimensions

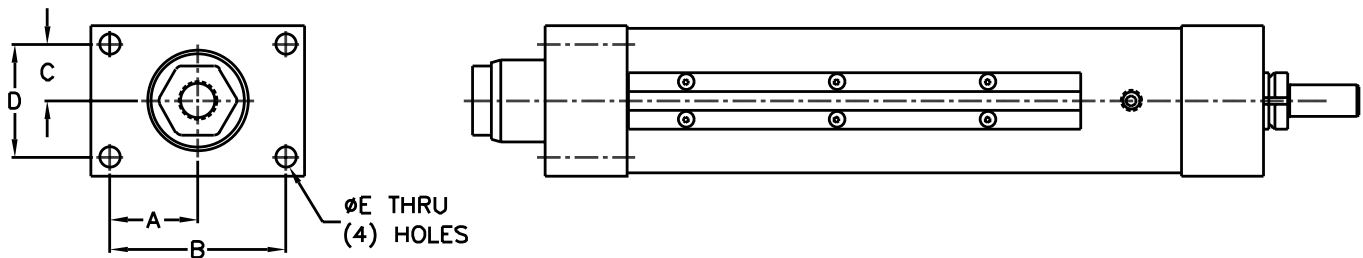

### ELIMINATOR HD™ Front Flange Mount Dimensions

Model	A	B	C	D	E	F	G	H	J	K	L	M	N
HD302	1.75	3.50	1.13	2.25	0.41	0.81	3.38	6.75	1.00	3/8-16	1.50	6.66	0.75
HD304	1.75	3.50	1.13	2.25	0.41	0.81	3.38	6.75	1.00	3/8-16	1.50	6.66	0.75
HD404	2.19	4.38	1.44	2.88	0.69	1.00	4.50	9.00	1.25	5/8-11	2.00	7.59	1.00
HD406	2.19	4.38	1.44	2.88	0.69	1.00	4.50	9.00	1.25	5/8-11	2.00	7.59	1.00
HD508	3.13	6.25	1.75	3.50	0.81	1.25	6.25	12.50	1.50	3/4-10	2.50	10.63	1.25
HD516	3.13	6.25	1.75	3.50	0.81	1.25	6.25	12.50	1.50	3/4-10	2.50	10.63	1.25
HD618	3.31	6.63	2.00	4.00	1.06	1.50	7.13	14.25	2.00	1-8	3.00	11.00	1.63
HD625	3.31	6.63	2.00	4.00	1.06	1.50	7.13	14.25	2.00	1-8	3.00	13.75	1.63

## ELIMINATOR HD™ Foot Mount Dimensions

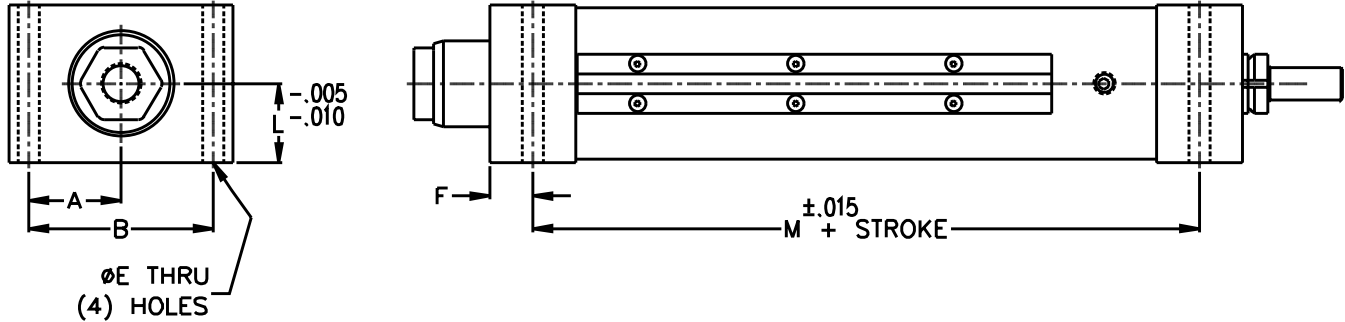

Note: DXF and DWG files are available at [www.edriveactuators.com](http://www.edriveactuators.com)

## ELIMINATOR HD™ Foot Mount Dimensions

Model	A	B	C	D	E	F	G	H	J	K	L	M	N
HD302	1.75	3.50	1.13	2.25	0.41	0.81	3.38	6.75	1.00	3/8-16	1.50	6.66	0.75
HD304	1.75	3.50	1.13	2.25	0.41	0.81	3.38	6.75	1.00	3/8-16	1.50	6.66	0.75
HD404	2.19	4.38	1.44	2.88	0.69	1.00	4.50	9.00	1.25	5/8-11	2.00	7.59	1.00
HD406	2.19	4.38	1.44	2.88	0.69	1.00	4.50	9.00	1.25	5/8-11	2.00	7.59	1.00
HD508	3.13	6.25	1.75	3.50	0.81	1.25	6.25	12.50	1.50	3/4-10	2.50	10.63	1.25
HD516	3.13	6.25	1.75	3.50	0.81	1.25	6.25	12.50	1.50	3/4-10	2.50	10.63	1.25
HD618	3.31	6.63	2.00	4.00	1.06	1.50	7.13	14.25	2.00	1-8	3.00	11.00	1.63
HD625	3.31	6.63	2.00	4.00	1.06	1.50	7.13	14.25	2.00	1-8	3.00	13.75	1.63

## ELIMINATOR HD™ Trunnion Mount Dimensions

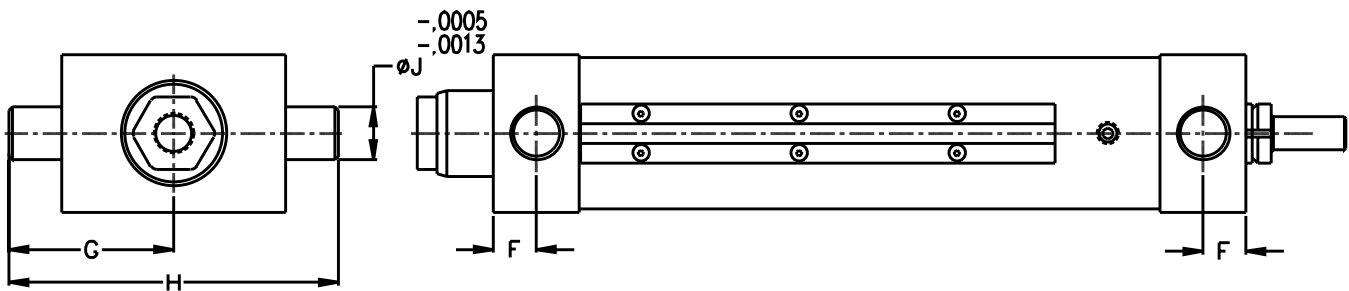

Note: DXF and DWG files are available at [www.edriveactuators.com](http://www.edriveactuators.com)

## ELIMINATOR HD™ Trunnion Mount Dimensions

Model	A	B	C	D	E	F	G	H	J	K	L	M	N
HD302	1.75	3.50	1.13	2.25	0.41	0.81	3.38	6.75	1.00	3/8-16	1.50	6.66	0.75
HD304	1.75	3.50	1.13	2.25	0.41	0.81	3.38	6.75	1.00	3/8-16	1.50	6.66	0.75
HD404	2.19	4.38	1.44	2.88	0.69	1.00	4.50	9.00	1.25	5/8-11	2.00	7.59	1.00
HD406	2.19	4.38	1.44	2.88	0.69	1.00	4.50	9.00	1.25	5/8-11	2.00	7.59	1.00
HD508	3.13	6.25	1.75	3.50	0.81	1.25	6.25	12.50	1.50	3/4-10	2.50	10.63	1.25
HD516	3.13	6.25	1.75	3.50	0.81	1.25	6.25	12.50	1.50	3/4-10	2.50	10.63	1.25
HD618	3.31	6.63	2.00	4.00	1.06	1.50	7.13	14.25	2.00	1-8	3.00	11.00	1.63
HD625	3.31	6.63	2.00	4.00	1.06	1.50	7.13	14.25	2.00	1-8	3.00	13.75	1.63



**ELIMINATOR HD™ Rod End Dimensions**

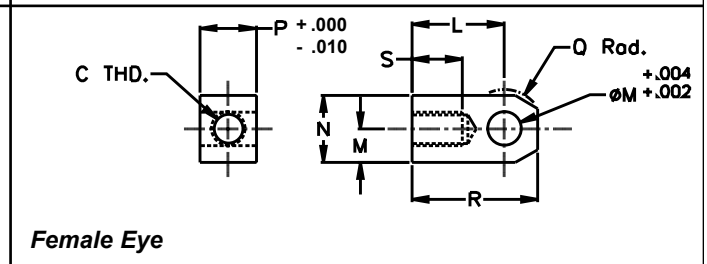
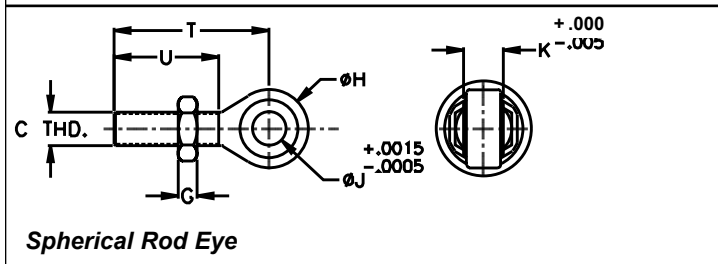
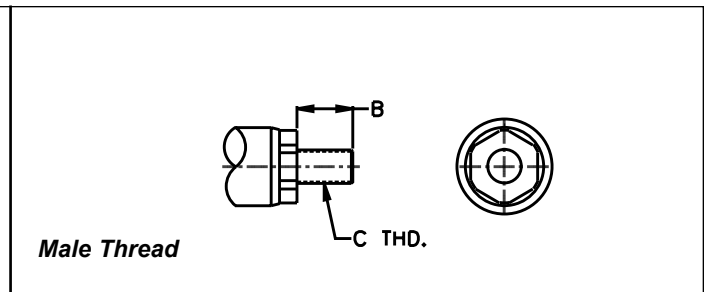
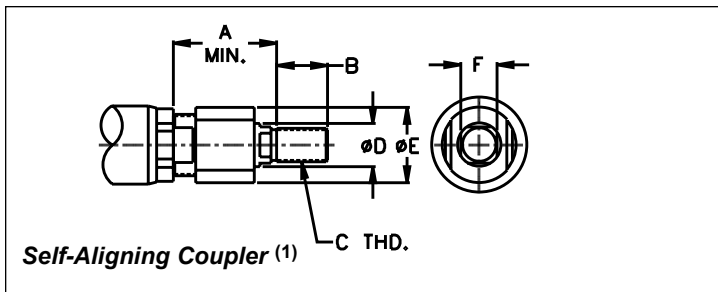
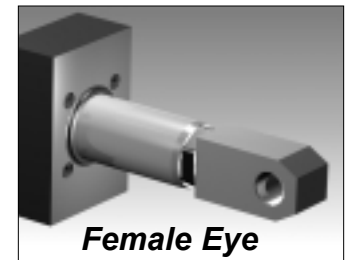
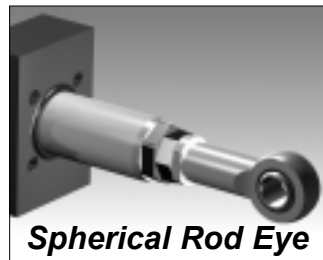
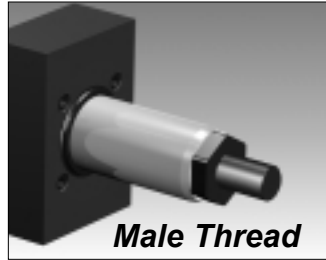
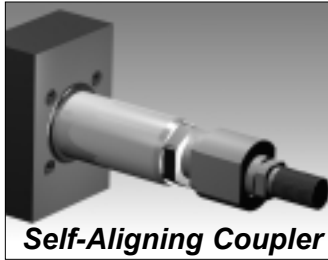

**ELIMINATOR HD™ Rod End Dimensions**

Model	A	B	C	D	E	F	G	H	J	K	L	M	N
HD302	2.31	1.13	3/4-16	0.97	1.75	0.88	0.42	1.75	0.75	0.88	2.06	0.75	1.50
HD304	2.31	1.13	3/4-16	0.97	1.75	0.88	0.42	1.75	0.75	0.88	2.06	0.75	1.50
HD404	2.31	1.13	3/4-16	0.97	1.75	0.88	0.42	1.75	0.75	0.88	2.06	0.75	1.50
HD406	2.31	1.13	3/4-16	0.97	1.75	0.88	0.42	1.75	0.75	0.88	2.06	0.75	1.50
HD508	2.94	1.63	1 1/4-12	1.38	2.50	1.25	0.72	2.75	1.00	1.38	3.44	1.38	2.75
HD516	2.94	1.63	1 1/4-12	1.38	2.50	1.25	0.72	2.75	1.00	1.38	3.44	1.38	2.75
HD618	2.94	1.63	1 1/4-12	1.38	2.50	1.25	0.72	2.75	1.00	1.38	3.44	1.38	2.75
HD625	2.94	1.63	1 1/4-12	1.38	2.50	1.25	0.72	2.75	1.00	1.38	3.44	1.38	2.75

Model	P	Q	R	S	T	U
HD302	1.25	0.88	2.81	1.13	2.88	1.75
HD304	1.25	0.88	2.81	1.13	2.88	1.75
HD404	1.25	0.88	2.81	1.13	2.88	1.75
HD406	1.25	0.88	2.81	1.13	2.88	1.75
HD508	2.00	1.56	4.81	2.00	4.13	2.13
HD516	2.00	1.56	4.81	2.00	4.13	2.13
HD618	2.00	1.56	4.81	2.00	4.13	2.13
HD625	2.00	1.56	4.81	2.00	4.13	2.13

(1) Zero backlash version also available

## How To Order:

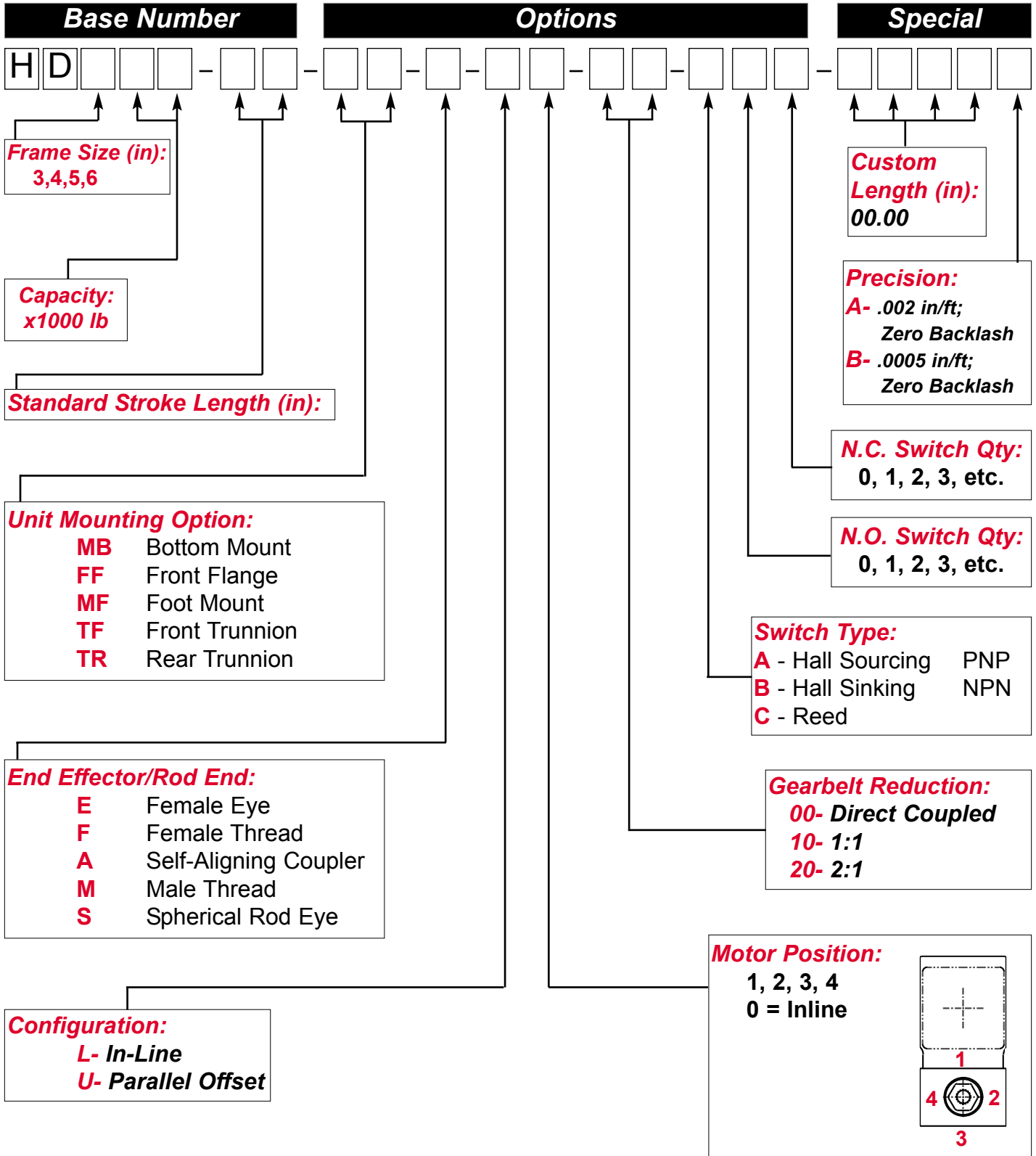

## Key Issues for Tough Actuator Applications

When calculating the required **force**, consider the force to accelerate the mass as well as the force to overcome friction and the applied force. For sizing the system, consider the maximum force and duration. For evaluating life under varying loads, calculate the root mean cube equivalent load which weights the different load levels by the typical length traveled under that load.

Linear **velocity** is limited by: (1) the maximum ball screw rpm without "whipping" of the ball screw shaft; and (2) critical speeds for the ball nut assembly (beyond which the motion of the balls becomes erratic and performance life suffers).

**Life** under load (B10 life) is predictable; severe load applications can generally be compensated for by providing additional capacity - this can be calculated.

**Alignment** of the actuator, parallel to the line of motion, is critical. Also, the end effector connection must be designed to prevent any transfer of bending moments back to the actuator .

**Side loads** are generally undesirable. Almost any force not coaxial to the actuator compromises potential life. Isolate the actuator from all bending moments or at least recognize and minimize

the amount of side loading. Where side loading is unavoidable, specify a linear actuator designed to accommodate side loading. For example, the EDrive **STRONGARM** Series.

Maximum **acceleration** of a ball screw assembly is approximately 32 ft/sec<sup>2</sup>, above this level, unit life becomes shorter and less predictable.

**Impact** is unacceptable to ball screws as well as anti-friction bearings. Severely shortened life and/or catastrophic failure are the results. Avoid impact or provide a mechanical system to buffer the ball screw assembly from shock loads. Install and connect limit switches before operating the actuator.

Good **lubrication** is essential. Use a high quality, extreme pressure grease without graphite or MOS2 additives. The actuator comes from the factory prelubricated. Inspect, and regrease every 1,000 hours. Do not mix lubricants; remove the old grease before changing the type of grease.

**Contamination** of the ball screw system is the leading cause of premature failure. Providing a continuous, low pressure, air purge to the system is a good way to ensure clean operation.

## Other E•Drive Linear Actuator Solutions

**HDL: Load Cell Actuator**



**VT: Versatile Thrust Actuator**

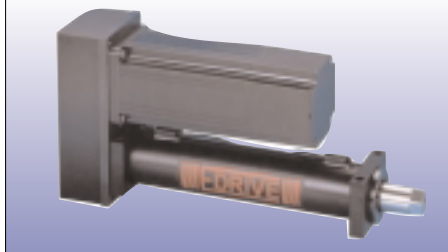

**SL: Sideload Capable Actuator**



# **ELIMINATOR HD™**

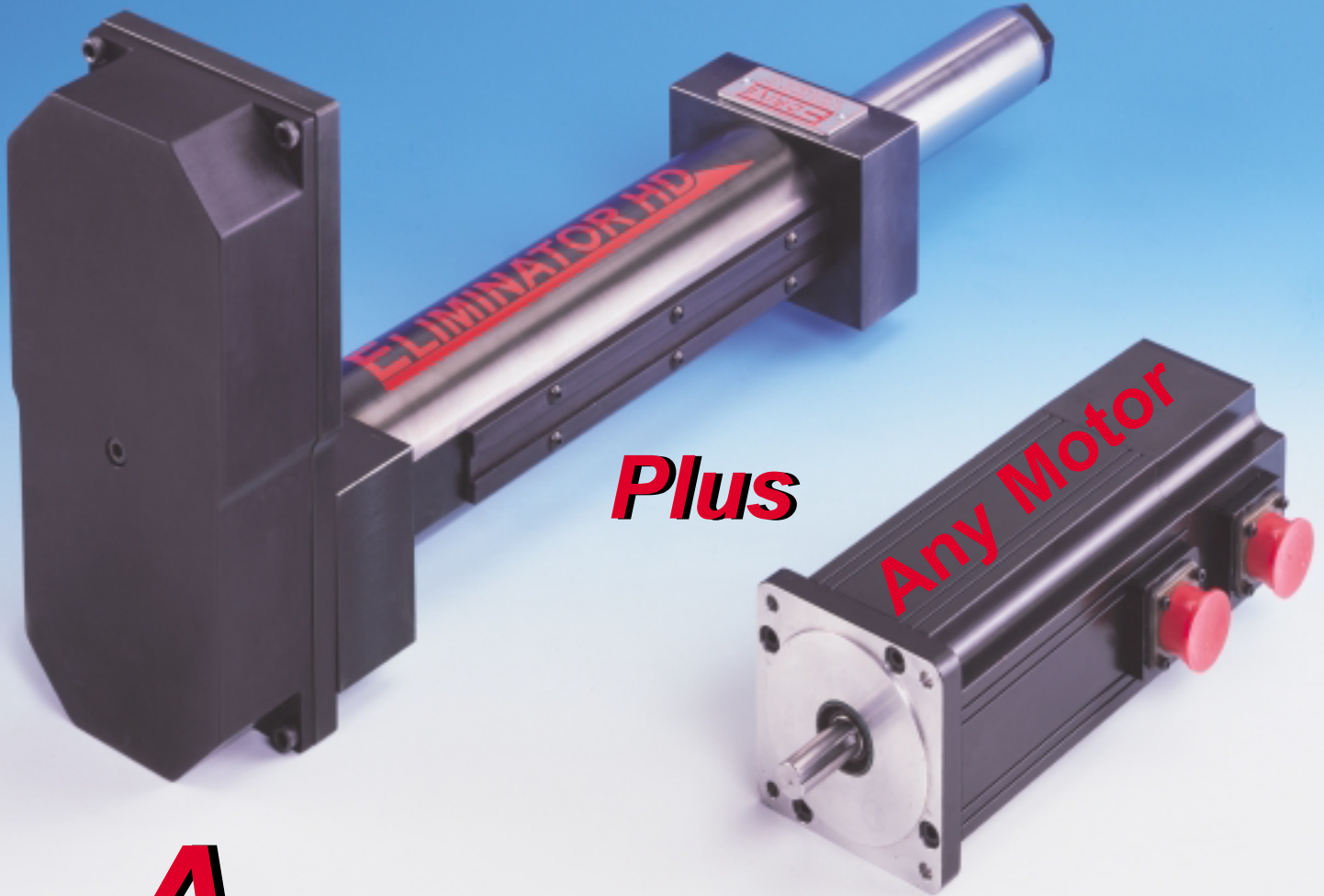

# **A Perfect Combination**

**EDRIVE**  
ACTUATORS

The products shown in this catalog are intended for industrial use only and should not be used to lift, support or otherwise transport people, unless written authorization is obtained. The information provided in this catalog is believed to be accurate and reliable. However, EDrive assumes no responsibility for its use or for any errors that may appear in this document. This information in this publication is subject to change without notice.

**For Application Support  
Call us Today at**

**800-878-1157**  
Fax: 860-953-0496  
Tel: 860-953-0588