

# EPSILON XCHANGE™ Tool Changer ER125LP/ET125LP

ER125LP/ET125LP is an automatic tool changing assembly for exchanging robotic end-of-arm tooling (EOAT) on the fly.

## Advantages:

- High Strength Aluminum Alloy Body
- Cam Locking Mechanism with **Lifetime Guarantee**
  - Self-Centering
  - Wear Compensating
  - Self-Cleaning
  - Positive Cam Retraction
  - Mechanical Locking (Loss of Air)
- Flexible Utility Options
- Couple/Uncouple Sensing

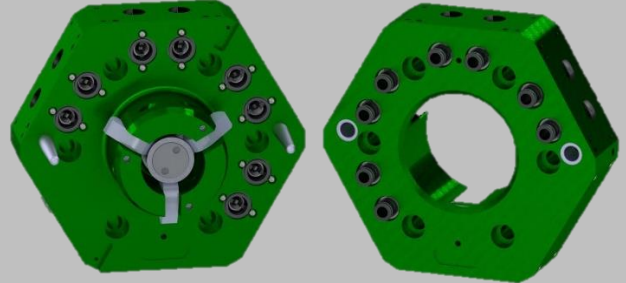

## SPECIFICATIONS

Model	Rated Payload	Operating Moment (M <sub>x</sub> , M <sub>y</sub> )	E-Stop Moment (M <sub>x</sub> , M <sub>y</sub> )	Operating Torque (M <sub>z</sub> )	E-Stop Torque (M <sub>z</sub> )	Tensile Force (F <sub>r</sub> )	Compressive Force (F <sub>c</sub> )	Rotational Repeatability	User Pneumatic Flow (at 60 psi)	User Pneumatic Pressure Range	Couple/Uncouple Sensing Voltage
	kg (lb)	Nm (in-lb)	Nm (in-lb)	Nm (in-lb)	Nm (in-lb)	N (lb)	N (lb)	deg.	NLPM (SCFM)	bar (psi)	VDC
<b>E31.5</b>	10 (22)	52 (465)	79 (700)	30 (265)	60 (520)	934 (210)	4,159 (935)	± .04	179 (6.9)	0 - 7 (0 - 101)	10 - 30
<b>E50</b>	25 (55)	88 (780)	168 (1,485)	120 (1,060)	375 (3,320)	3,336 (750)	17,837 (4,010)	± .02	285 (11)	0 - 7 (0 - 101)	10 - 30
<b>E63</b>	50 (110)	112 (990)	168 (1,485)	220 (1,945)	375 (3,320)	3,336 (750)	17,837 (4,010)	± .02	285 (11)	0 - 7 (0 - 101)	10 - 30
<b>E80</b>	90 (198)	465 (4,120)	890 (7,880)	640 (5,665)	1,585 (14,025)	13,345 (3,000)	31,649 (7,115)	± .01	376 (14.5)	0 - 7 (0 - 101)	10 - 30
<b>E100</b>	120 (264)	548 (4,850)	890 (7,880)	960 (8,495)	1,585 (14,025)	13,345 (3,000)	31,649 (7,115)	± .01	376 (14.5)	0 - 7 (0 - 101)	10 - 30
<b>E125LP</b>	225 (495)	1,737 (15,730)	2,875 (25,459)	2,020 (17,875)	3,953 (34,985)	15,750 (3,540)	49,370 (11,100)	± .01	Contact Applications Engineering	0 - 7 (0 - 101)	10 - 30
<b>E125</b>	350 (770)	2,576 (22,800)	4,817 (42,631)	4,180 (36,995)	5,110 (45,225)	24,754 (5,565)	127,998 (28,775)	± .01	N/A	N/A	22 - 28
<b>E160</b>	525 (1,155)	3,775 (33,405)	5,787 (51,220)	4,800 (42,480)	5,945 (52,615)	37,120 (8,345)	160,003 (35,970)	± .01	N/A	N/A	22 - 28
<b>E160 (STL) *</b>	525 (1,155)	4,300 (38,060)	9,095 (80,490)	4,800 (42,480)	5,945 (52,615)	37,120 (8,345)	160,003 (35,970)	± .01	N/A	N/A	22 - 28
<b>ES160</b>	800 (1,760)	5,649 (50,000)	11,322 (100,215)	5,280 (46,730)	6,690 (59,210)	49,486 (11,125)	160,003 (35,970)	± .01	N/A	N/A	22 - 28
<b>ES200</b>	1,500 (3,300)	15,097 (133,620)	17,998 (159,300)	11,660 (103,200)	14,590 (129,130)	96,393 (21,670)	246,031 (55,310)	± .01	N/A	N/A	22 - 28

\* E160 (STL) utilizes a steel tool side and an aluminum robot side.

Operating Temperature: 5 - 60 °C (40 - 140 °F)

Noise Emissions: < = 70 dB(A) in any direction

Supply Pressure: 5 - 7 bar (72 - 101 psi)

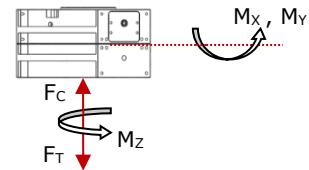

## SECTIONAL DIAGRAM

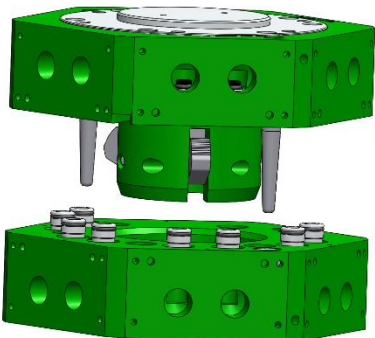

Applied Robotics XCHANGE™ automatic tool changing technology allows for exchanging robotic end-of-arm tooling (EOAT) on the fly without shutting down production lines. Not only does this add efficiency to processes requiring frequent connection/disconnection of tooling and support utilities, but also reduces the probability of human errors introduced by manual connections.

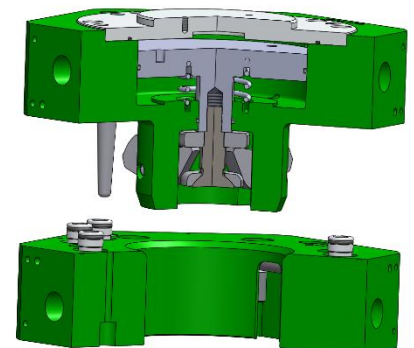

**Applied Robotics™**  
Solutions in reach

## PRODUCT INFORMATION

### ROBOT ADAPTOR

ROBOT ADAPTOR WEIGHT: 3.14 kg [6.84 lbs]

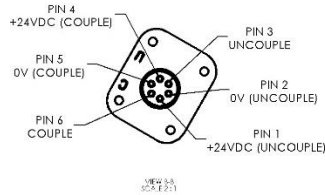
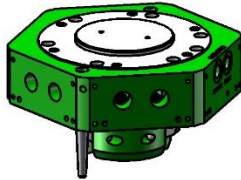

### TOOL ADAPTOR

TOOL ADAPTOR WEIGHT: 2.25 kg [5.10 lbs]

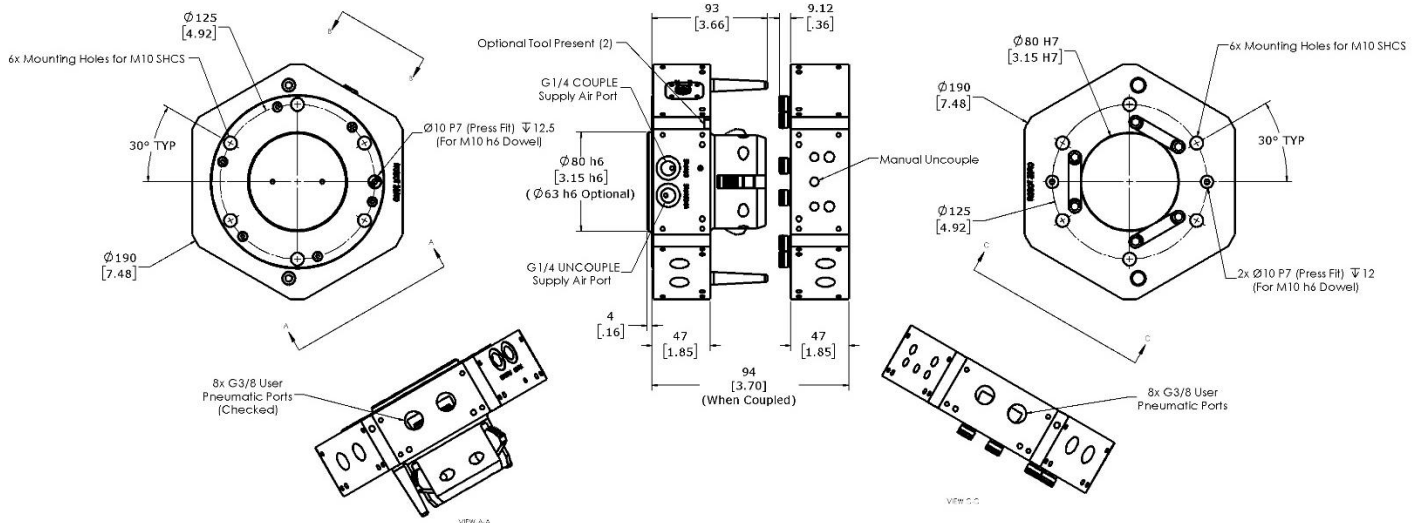
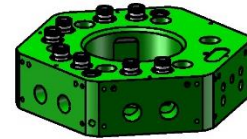

## OPTIONAL UTILITIES

1. 8x G3/8 User Pneumatic Ports  
(Checked on Robot Side)
2. Additional Pneumatic Passthru
3. Electrical Passthru (Signal, Communication, etc.)
4. Servo (Power & Encoder/Resolver)

